

Marketing Bulletin

DATE: August 25, 2005
TO: All Sales Personnel
FROM: Mark Stoner
RE: Product Termination

To all concerned parties,

This bulletin is to notify all customers of the discontinuation of the following Ecliptek series effective August 25th, 2005:

Series	Description	Recommended Replacement
E11W1	5V 4 pad SMD LVPECL Oscillator	E13C7
E13W1	3.3V 4 pad SMD LVPECL Oscillator	E13C7

In compliance with our End of Life (EOL) policy, this will serve as advanced notice of product termination. New orders will not be accepted after November 25th, 2005, with delivery to conclude by February 25th 2006.

If there are any questions pertaining to this bulletin, please feel free to contact me. Thank you again for your cooperation.

Best Regards,

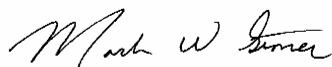

Mark W. Stoner
Director of Marketing
Ecliptek Corporation

E11W1 Series

- PECL Output Oscillators
- 5.0V supply voltage
- 4 pad PCB SMD package
- Stability to 20ppm
- Output Enable/Disable available
- Complementary Output available
- Available on Tape and Reel

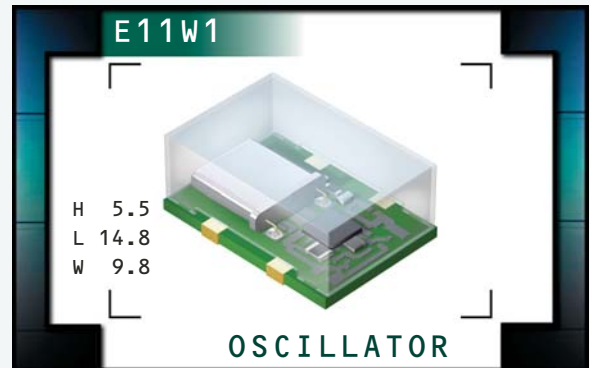

NOTES

OBSOLETE

ELECTRICAL SPECIFICATIONS

Frequency Range		19.440MHz to 250.000MHz
Operating Temperature Range		0°C to 70°C
	Available at Frequencies \leq 212.500MHz	-40°C to 85°C
Storage Temperature Range		-55°C to 125°C
Supply Voltage (V_{CC})		5.0V _{DC} \pm 5%
Input Current		100mA Maximum
Logic Type		100KH
Frequency Tolerance / Stability	Inclusive of all conditions: Calibration Tolerance at 25°C, Frequency Stability over the Operating Temperature Range, Supply Voltage Change, Output Load Change, Aging, Shock, and Vibration	\pm 100ppm, \pm 50ppm, \pm 25ppm, or \pm 20ppm Maximum
Output Voltage Logic High (V_{OH})		V_{CC} -1.025V _{DC} Minimum
Output Voltage Logic Low (V_{OL})		V_{CC} -1.620V _{DC} Maximum
Rise Time / Fall Time	20% to 80% of waveform	2 nSeconds Maximum
Duty Cycle	at 50% of waveform	50 \pm 10(%) 50 \pm 5(%)
Load Drive Capability		50 Ohms into V_{CC} -2.0V _{DC}
Logic Control / Additional Output		No Connect, Enable/Disable, or Complementary Output
Enable/Disable Input Voltage	V_{IL} of V_{CC} -1.475V _{DC} Maximum No Connection V_{IH} of V_{CC} -1.165V _{DC} Minimum	Enables Output Enables Output Disables Output: Logic Low
Start Up Time		10 mSeconds Maximum
RMS Phase Jitter	FJ = 12kHz to 20MHz	1 pSec Maximum

MANUFACTURER ECLIPTEK CORP.	CATEGORY OSCILLATOR	SERIES E11W1	PACKAGE 4-PCB	VOLTAGE 5.0V	CLASS 0577	REV. DATE 01/03
--------------------------------	------------------------	-----------------	------------------	-----------------	---------------	--------------------

PART NUMBERING GUIDE

E11W1 F 2 C - 155.520M TR

FREQUENCY TOLERANCE & STABILITY/ OPERATING TEMPERATURE RANGE

C=±100ppm Maximum over 0°C to +70°C
 D=±50ppm Maximum over 0°C to +70°C
 E=±25ppm Maximum over 0°C to +70°C
 F=±20ppm Maximum over 0°C to +70°C
 G=±100ppm Maximum over -40°C to +85°C
 H=±50ppm Maximum over -40°C to +85°C

DUTY CYCLE

1=50% ±10%, 2=50% ±5%

AVAILABLE OPTIONS

Blank= Tubes
 TR= Tape and Reel (Standard)

FREQUENCY

LOGIC CONTROL/ADDITIONAL OUTPUT

A= No Connect
 B= Enable/Disable
 C= Complementary Output

MECHANICAL DIMENSIONS ALL DIMENSIONS IN MILLIMETERS

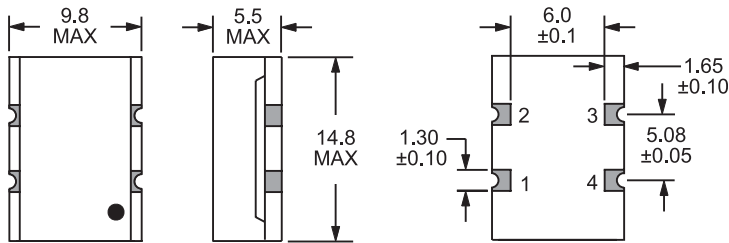

Pin 1: Complementary Output, No Connect, or Enable/Disable
 Pin 2: Case Ground Pin 3: Output Pin 4: Supply Voltage

SUGGESTED SOLDER PAD LAYOUT ALL DIMENSIONS IN MILLIMETERS

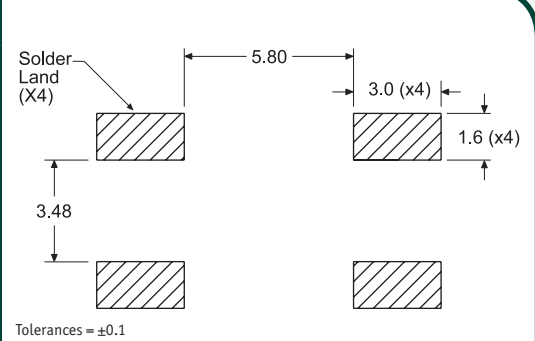

TAPE AND REEL DIMENSIONS ALL DIMENSIONS IN MILLIMETERS

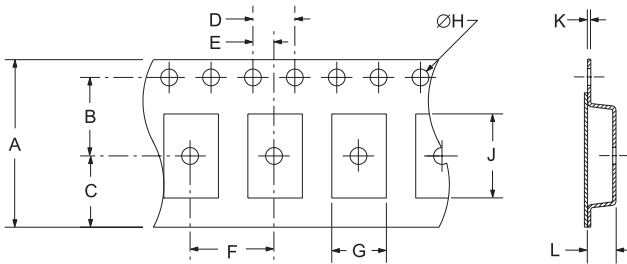

TAPE	A	B	C	D	E
	24 ±.3	11.5 ±.1	10.75 ±.1	4 ±.2	2 ±.1
F	G	H	J	K	L
12 ±.1	B0*	1.5 +.1-0	A0*	.4 ±.05	K0*

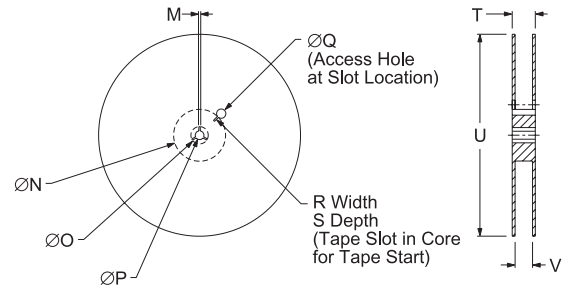

REEL	M	N	O	P	Q
	1.5 MIN	50 MIN	20.2 MIN	13 ±.2	40 MIN
R	S	T	U	V	QTY/REEL
2.5 MIN	10 MIN	30.4 MAX	360 MAX	24.4+2-0	1000

*Compliant to EIA 481A

ENVIRONMENTAL/MECHANICAL SPECIFICATIONS

Characteristic	Specification
Fine Leak Test	MIL-STD-883, Method 1014, Condition A
Gross Leak Test	MIL-STD-883, Method 1014, Condition C
Mechanical Shock	MIL-STD-202, Method 213, Condition C
Vibration	MIL-STD-883, Method 2007, Condition A
Solderability	MIL-STD-883, Method 2002
Temperature Cycling	MIL-STD-883, Method 1010
Resistance to Soldering Heat	MIL-STD-202, Method 210
Resistance to Solvents	MIL-STD-202, Method 215

MARKING SPECIFICATIONS

Line 1: ECLIPTEK
 Line 2: XX.XXX M
 Frequency in MHz (5 Digits Maximum + Decimal)
 Line 3: XX Y ZZ
 Week of Year
 Last Digit of Year
 Ecliptek Manufacturing Identifier

OBSOLETE

MIL-STD-883, Method 1014, Condition A	PACKAGE 4-PCB	VOLTAGE 5.0V	CLASS OS77
ECLIPTEK CORP.	OSCILLATOR	E11W1	REV. DATE 01/03

E13W1 Series

- PECL Output Oscillators
- 3.3V supply voltage
- 4 pad PCB SMD package
- Stability to 20ppm
- Output Enable/Disable available
- Complementary Output available
- Available on Tape and Reel

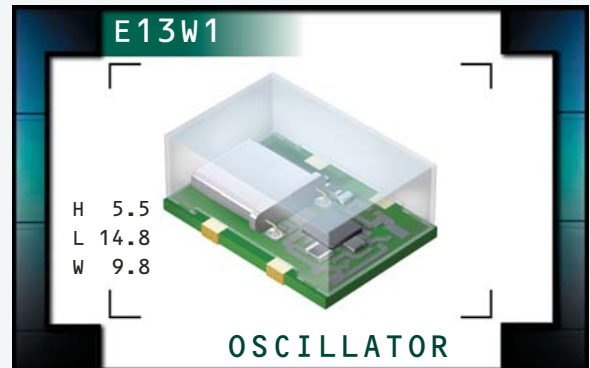

NOTES

OBSOLETE

ELECTRICAL SPECIFICATIONS

Frequency Range		19.440MHz to 250.000MHz
Operating Temperature Range		0°C to 70°C
	Available at Frequencies \leq 212.500MHz	-40°C to 85°C
Storage Temperature Range		-55°C to 125°C
Supply Voltage (V_{CC})		3.3V _{DC} \pm 5%
Input Current		75mA Maximum
Logic Type		100KH
Frequency Tolerance / Stability	Inclusive of all conditions: Calibration Tolerance at 25°C, Frequency Stability over the Operating Temperature Range, Supply Voltage Change, Output Load Change, Aging, Shock, and Vibration	\pm 100ppm, \pm 50ppm, \pm 25ppm, or \pm 20ppm Maximum
Output Voltage Logic High (V_{OH})		V_{CC} -1.025V _{DC} Minimum
Output Voltage Logic Low (V_{OL})		V_{CC} -1.620V _{DC} Maximum
Rise Time / Fall Time	20% to 80% of waveform	2 nSeconds Maximum
Duty Cycle	at 50% of waveform	50 \pm 10(%) 50 \pm 5(%)
Load Drive Capability		50 Ohms into V_{CC} -2.0V _{DC}
Logic Control / Additional Output		No Connect, Enable/Disable, or Complementary Output
Enable/Disable Input Voltage	V_{IL} of V_{CC} -1.475V _{DC} Maximum No Connection V_{IH} of V_{CC} -1.165V _{DC} Minimum	Enables Output Enables Output Disable Output: Logic Low
Start Up Time		10 mSeconds Maximum
RMS Phase Jitter	FJ = 12kHz to 20MHz	1 pSec Maximum

MANUFACTURER	CATEGORY	SERIES	PACKAGE	VOLTAGE	CLASS	REV. DATE
ECLIPTEK CORP.	OSCILLATOR	E13W1	4-PCB	3.3V	OS75	01/03

PART NUMBERING GUIDE

E13W1 F 2 C - 155.520M TR

FREQUENCY TOLERANCE & STABILITY/ OPERATING TEMPERATURE RANGE

C=±100ppm Maximum over 0°C to +70°C
 D=±50ppm Maximum over 0°C to +70°C
 E=±25ppm Maximum over 0°C to +70°C
 F=±20ppm Maximum over 0°C to +70°C
 G=±100ppm Maximum over -40°C to +85°C
 H=±50ppm Maximum over -40°C to +85°C

DUTY CYCLE

1=50% ±10%, 2=50% ±5%

AVAILABLE OPTIONS

Blank=Tubes
 TR=Tape and Reel (Standard)

FREQUENCY

LOGIC CONTROL/ADDITIONAL OUTPUT

A=No Connect
 B=Enable/Disable
 C=Complementary Output

MECHANICAL DIMENSIONS ALL DIMENSIONS IN MILLIMETERS

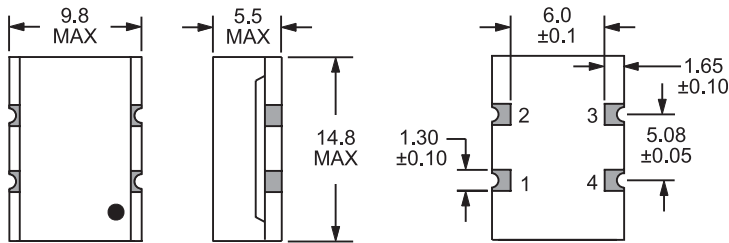

Pin 1: Complementary Output, No Connect, or Enable/Disable
 Pin 2: Case Ground Pin 3: Output Pin 4: Supply Voltage

SUGGESTED SOLDER PAD LAYOUT ALL DIMENSIONS IN MILLIMETERS

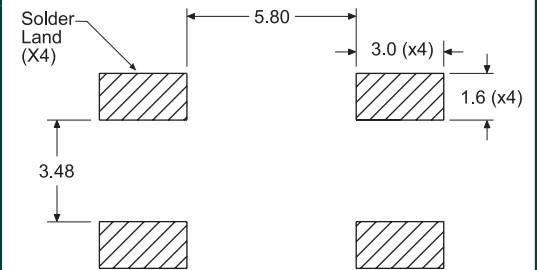

Tolerances = ±0.1

TAPE AND REEL DIMENSIONS ALL DIMENSIONS IN MILLIMETERS

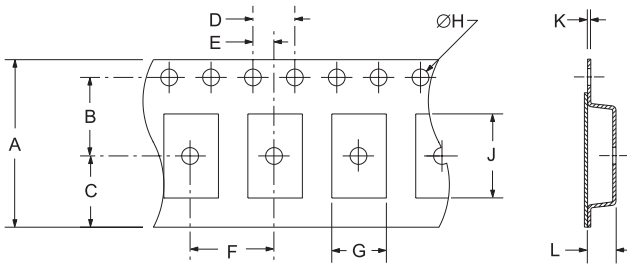

TAPE	A	B	C	D	E
	24 ±.3	11.5 ±.1	10.75 ±.1	4 ±.2	2 ±.1
F	G	H	J	K	L
	B0*	1.5 ±.1-0	A0*	.4 ±.05	K0*

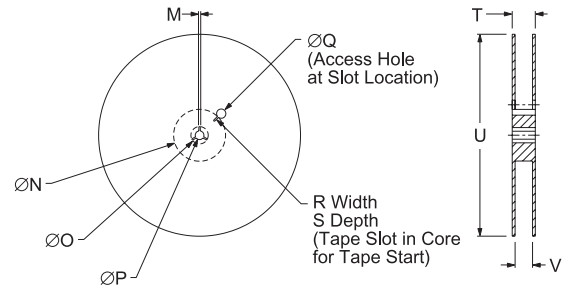

REEL	M	N	O	P	Q	
	1.5 MIN	50 MIN	20.2 MIN	13 ±.2	40 MIN	
R	S	T	U	V	QTY/REEL	
	2.5 MIN	10 MIN	30.4 MAX	360 MAX	24.4+2-0	1000

*Compliant to EIA 481A

ENVIRONMENTAL/MECHANICAL SPECIFICATIONS

Characteristic	Specification
Fine Leak Test	MIL-STD-883, Method 1014, Condition A
Gross Leak Test	MIL-STD-883, Method 1014, Condition C
Mechanical Shock	MIL-STD-202, Method 213, Condition C
Vibration	MIL-STD-883, Method 2007, Condition A
Solderability	MIL-STD-883, Method 2002
Temperature Cycling	MIL-STD-883, Method 1010
Resistance to Soldering Heat	MIL-STD-202, Method 210
Resistance to Solvents	MIL-STD-202, Method 215

MARKING SPECIFICATIONS

Line 1: ECLIPTEK
 Line 2: XX.XXX M
 Frequency in MHz (5 Digits Maximum + Decimal)
 Line 3: XX Y ZZ
 Week of Year
 Last Digit of Year
 Ecliptek Manufacturing Identifier

OBSOLETE

MANUFACTURER ECLIPTEK CORP.	PACKAGE OSCILLATOR	PART NUMBER E13W1	PACKAGE 4-PCB	VOLTAGE 3.3V	CLASS 0575	REV. DATE 01/03
--------------------------------	-----------------------	----------------------	------------------	-----------------	---------------	--------------------