

●Features

- 1) Transistor elements are independent, eliminating interference.
- 2) Mounting possible with EMT3 or UMT3 or SMT3 automatic mounting machines.
- 3) Mounting cost and area can be cut in half.

●Structure

NPN / PNP epitaxial planar silicon transistor

●Equivalent circuit

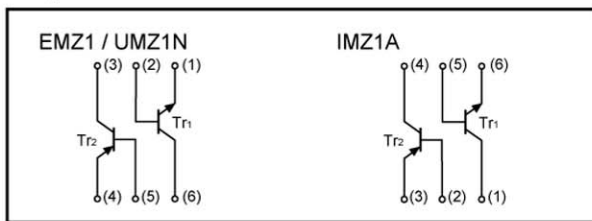

●Absolute maximum ratings (Ta = 25°C)

Parameter	Symbol	Limits		Unit
		Tr1	Tr2	
Collector-base voltage	V _{CB0}	60	□60	V
Collector-emitter voltage	V _{CE0}	50	□50	V
Emitter-base voltage	V _{EB0}	7	□6	V
Collector current	I _c	150	□150	mA
Power dissipation	EMZ1, UMZ1N	P _c	150 (TOTAL)	mW <input type="checkbox"/> 1
	IMZ1A		300 (TOTAL)	
Junction temperature	T _j	150		°C
Storage temperature	T _{stg}	□55 □150		°C

- 1 120mW per element must not be exceeded.
2 200mW per element must not be exceeded.

●External dimensions (Units : mm)

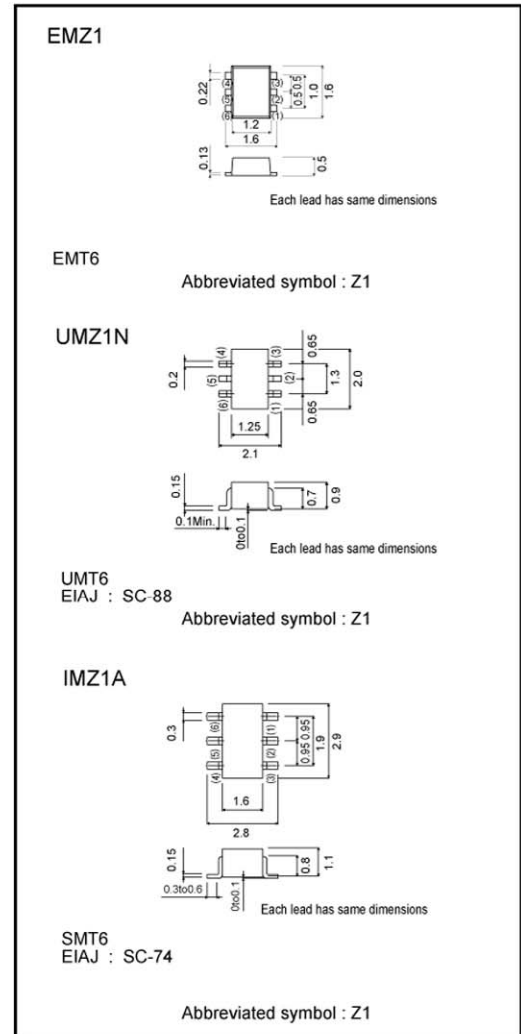

● **Electrical characteristics** (Ta = 25°C)

Tr1 (NPN)

Parameter	Symbol	Min.	Typ.	Max.	Unit	Conditions
Collector-base breakdown voltage	BV _{CB0}	60			V	I _C =50 μA
Collector-emitter breakdown voltage	BV _{CE0}	50			V	I _C =1mA
Emitter-base breakdown voltage	BV _{EB0}	7			V	I _E =50 μA
Collector cutoff current	I _{CB0}			0.1	μA	V _{CB} =60V
Emitter cutoff current	I _{EB0}			0.1	μA	V _{EB} =7V
Collector-emitter saturation voltage	V _{CE(sat)}			0.4	V	I _C /I _B =50mA/5mA
DC current transfer ratio	h _{FE}	120		560		V _{CE} =6V, I _C =1mA
Transition frequency	f _T		180		MHz	V _{CE} =12V, I _E =2mA, f=100MHz
Output capacitance	C _{ob}		2	3.5	PF	V _{CB} =12V, I _E =0A, f=1MHz

Tr2 (PNP)

Parameter	Symbol	Min.	Typ.	Max.	Unit	Conditions
Collector-base breakdown voltage	BV _{CB0}	60			V	I _C =50 μA
Collector-emitter breakdown voltage	BV _{CE0}	50			V	I _C =1mA
Emitter-base breakdown voltage	BV _{EB0}	6			V	I _E =50 μA
Collector cutoff current	I _{CB0}			0.1	μA	V _{CB} =60V
Emitter cutoff current	I _{EB0}			0.1	μA	V _{EB} =6V
Collector-emitter saturation voltage	V _{CE(sat)}			0.5	V	I _C /I _B =50mA/5mA
DC current transfer ratio	h _{FE}	120		560		V _{CE} =6V, I _C =1mA
Transition frequency	f _T		140		MHz	V _{CE} =12V, I _E =2mA, f=100MHz
Output capacitance	C _{ob}		4	5	PF	V _{CB} =12V, I _E =0A, f=1MHz

● **Electrical characteristic curves**

Tr1 (NPN)

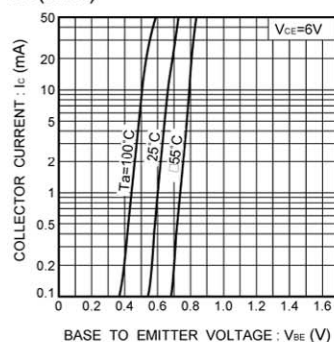

Fig.1 Grounded emitter propagation characteristics

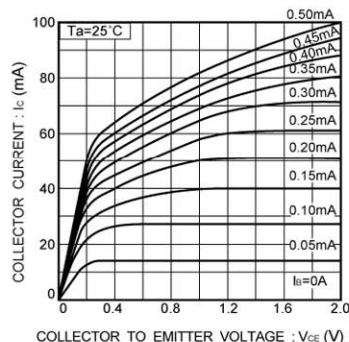

Fig.2 Grounded emitter output characteristics (I)

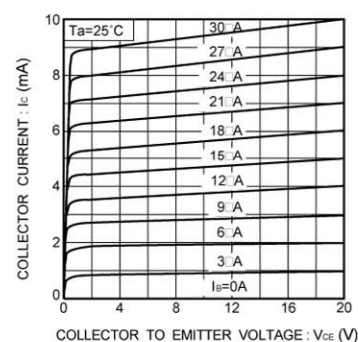

Fig.3 Grounded emitter output characteristics (II)



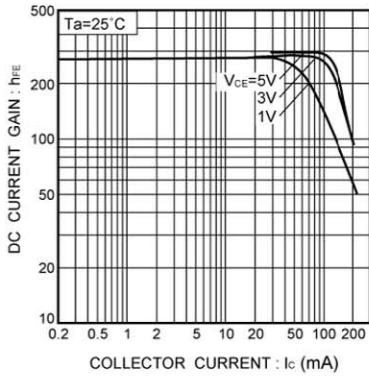

Fig.4 DC current gain vs. collector current (I)

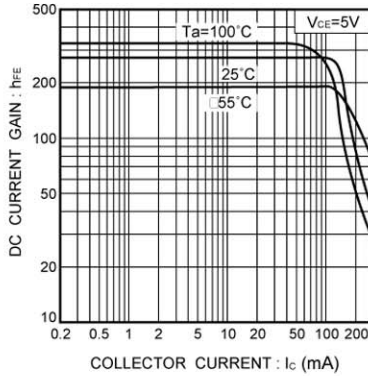

Fig.5 DC current gain vs. collector current (II)

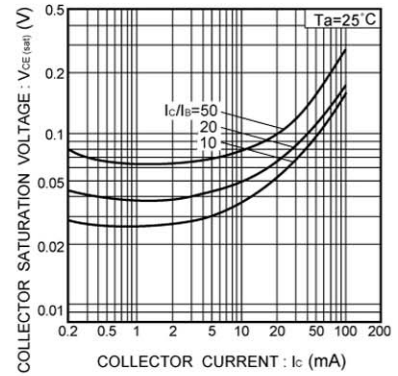

Fig.6 Collector-emitter saturation voltage vs. collector current (I)

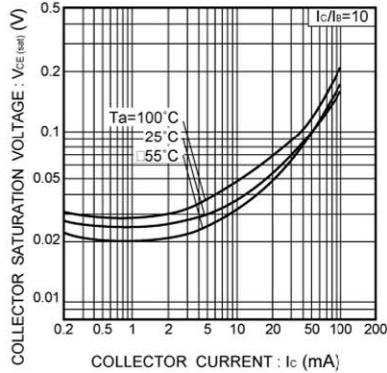

Fig.7 Collector-emitter saturation voltage vs. collector current (II)

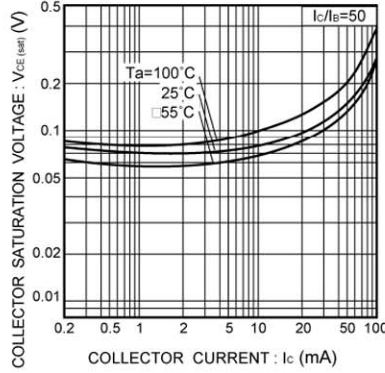

Fig.8 Collector-emitter saturation voltage vs. collector current (III)

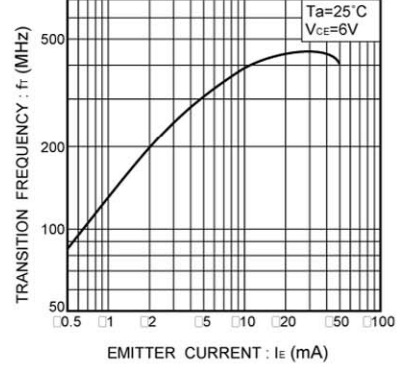

Fig.9 Gain bandwidth product vs. emitter current

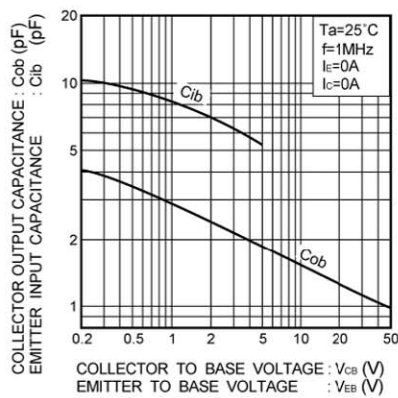

Fig.10 Collector output capacitance vs. collector-base voltage
Emitter input capacitance vs. emitter-base voltage

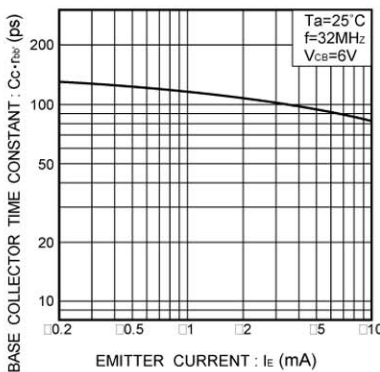

Fig.11 Base-collector time constant vs. emitter current

