

ERA37 (0.5A)

(800, 1000V / 0.5A)

FAST RECOVERY DIODE

■ Outline drawings, mm

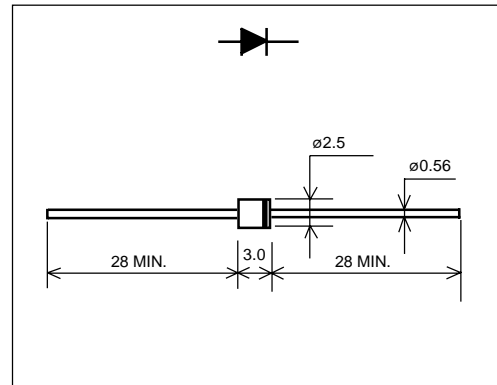

■ Features

- High speed switching
- Ultra small package
Possible for 5mm pitch automatic insertion
- High reliability

■ Applications

- High speed switching

■ Maximum ratings and characteristics

- Absolute maximum ratings

Item	Symbol	Conditions	Rating		Unit
			08	10	
Repetitive peak reverse voltage	V_{RRM}		800	1000	V
Non-repetitive peak reverse voltage	V_{RRM}		800	1000	V
Average forward current	$I_{F(AV)}$	Resistive load ($T_I = 130^\circ\text{C}$)	0.5		A
Surge current	I_{FSM}	Sine wave 10ms	10		A
Operating junction temperature	T_j		-40 to +150		$^\circ\text{C}$
Storage temperature	T_{stg}		-40 to +150		$^\circ\text{C}$

- Electrical characteristics ($T_a = 25^\circ\text{C}$ Unless otherwise specified)

Item	Symbol	Conditions	Max.	Unit
Forward voltage drop	V_{FM}	$I_{FM} = 0.5\text{A}$	3.0	V
Reverse current	I_{RRM}	$V_R = V_{RRM}$	10	μA
Reverse recovery time	t_{rr}	$I_F = 0.1\text{A}, I_R = 0.1\text{A}$	0.25	μs

■ Marking

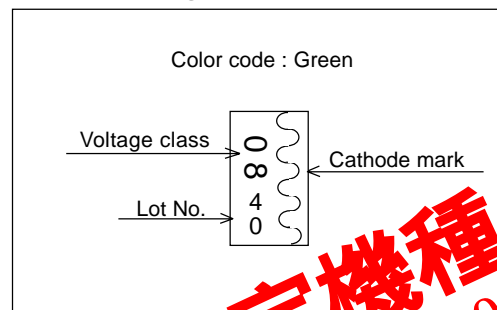

Characteristics

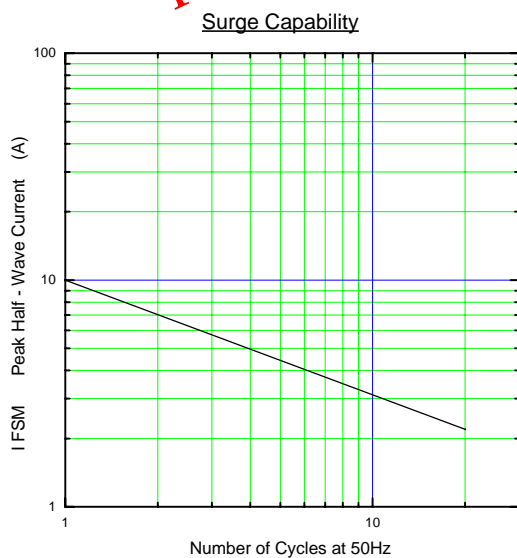
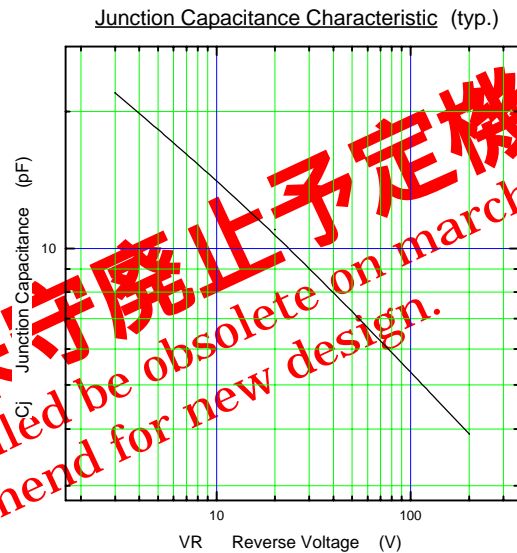
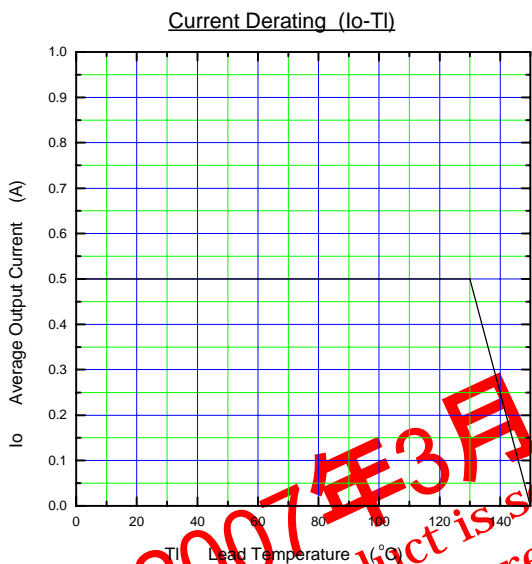
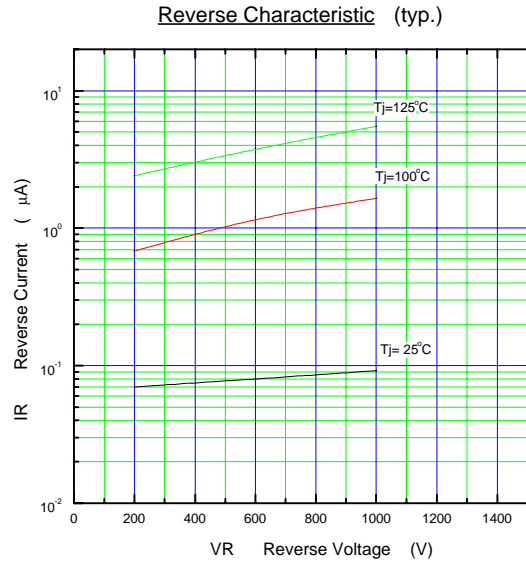
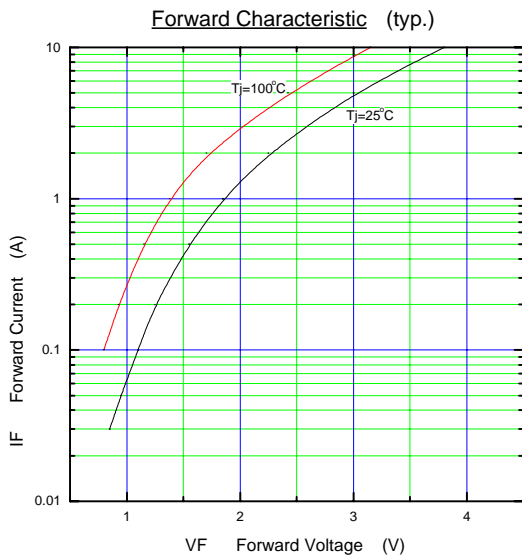

2007年3月 保守廃止予定機種
This product is scheduled to be obsolete on march 2007.
Not recommend for new design.