

Ultra Low Capacitance ESD Protection -ESD0524P

Description

The ESD0524P have a typical capacitance of only 0.35pF between I/O pins. This allows it to be used on circuits operating in excess of 4GHz without signal attenuation. They have been specifically designed to protect sensitive components which are connected to high-speed data and transmission lines from overvoltage caused by ESD (electrostatic discharge), CDE (Cable Discharge Events), and EFT (electrical fast transients). They used to meet the ESD immunity requirements of IEC 61000-4-2, Level 4 ($\pm 15\text{kV}$ air, $\pm 8\text{kV}$ contact discharge).

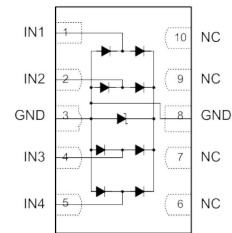
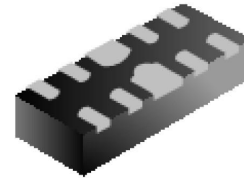

Schematic and PIN Configuration

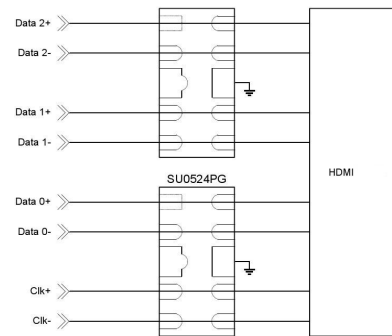

HDMI Port Protection

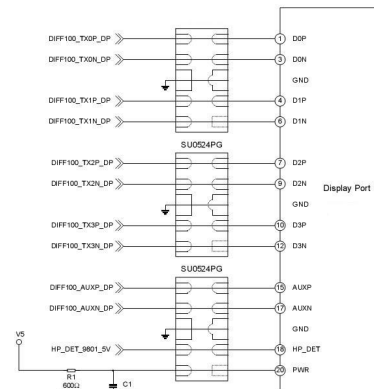

Display Port Protection

Features

- Case :DFN-10-2.5*1.0*0.6-0.5
- Package design optimized for high speed lines
- Low clamping voltage
- Low capacitance :0.35 pF typical (I/O to I/O)
- Protection four I/O Lines
- Compatible with IEC 61000-4-2(ESD) :Air 15KV , Contact 8KV
- Compatible with IEC 61000-4-4(EFT) :40A ,5/50 nS
- Compatible with IEC 61000-4-5(Surge):5A ,8/20 uS

Applications

- High Definition Multi-Media Interface (HDMI)
- DisplayPort Interface
- Digital Visual Interface (DVI)
- eSATA Interfaces
- MDDI Ports
- PCI Express

Absolute Maximum Ratings

Parameter	Symbol	Value	Units
Peak Current ($t_p = 8/20 \mu s$)	P_{PK}	150	W
Peak Current ($t_p = 8/20 \mu s$)	I_{PP}	5	A
IEC61000-4-2 (Contact)	V_{ESD}	8	kV
IEC61000-4-2 (Air)	V_{ESD}	15	kV
Lead Soldering Temperature	T_L	260 (10 sec)	$^{\circ} C$
Operating Temperature	T_J	-50 to +125	$^{\circ} C$
Storage Temperature Range	T_{STG}	-50 to +150	$^{\circ} C$

Electrical Characteristics ($T = 25^{\circ} C$)

Parameter	Symbol	Conditions	Min.	Typ.	Max.	Units
Reverse Stand-off Voltage	V_{RWM}	Any I/O pin to ground			5	V
Reverse Breakdown Voltage	V_{BR}	$I_t = 1mA$ Any I/O pin to ground	6			V
Reverse Leakage Current	I_R	$V_{RWM} = 5.0V, T = 25^{\circ}C$ Any I/O pin to ground			1	μA
Clamping Voltage	V_C	$I_{PP} = 1A, t_p = 8/20\mu s$ Any I/O pin to ground		8.5	12	V
Junction Capacitance	C_J	$V_R = 0V, f = 1MHz$ Between I/O pins		0.35		pF

Rating & Characteristic Curves

Figure 1- Power Derating Curve

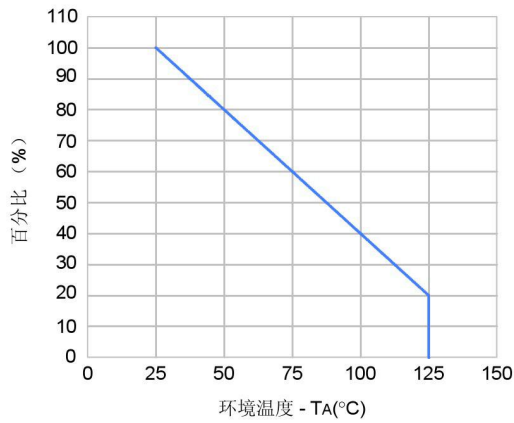

Figure 2- Clamping Voltage vs Current

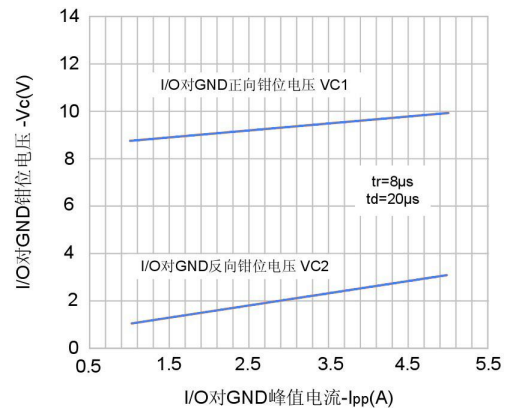

Figure 3- Typical Junction Capacitance

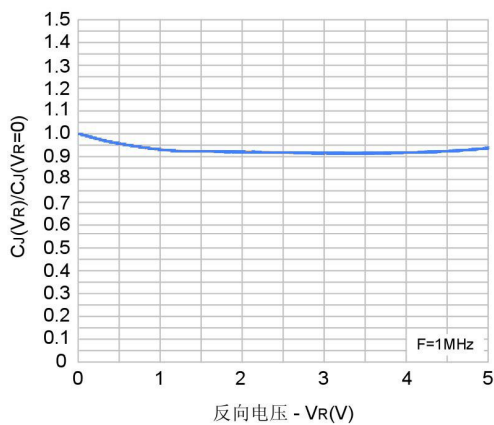

Figure 4- Pulse Waveform

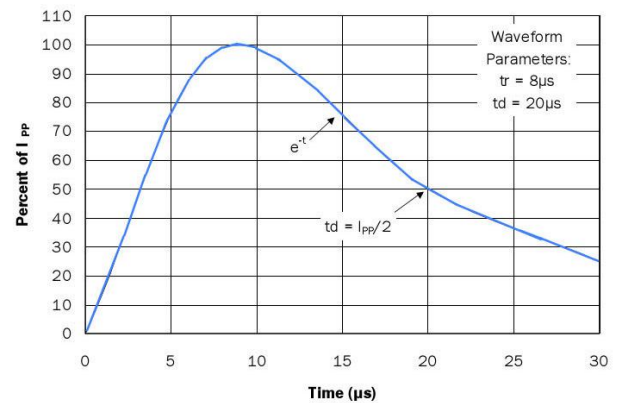
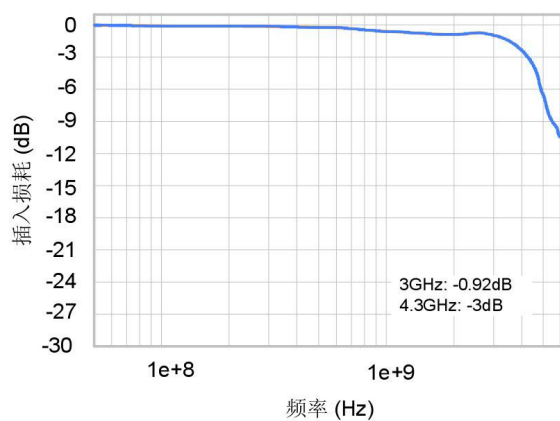
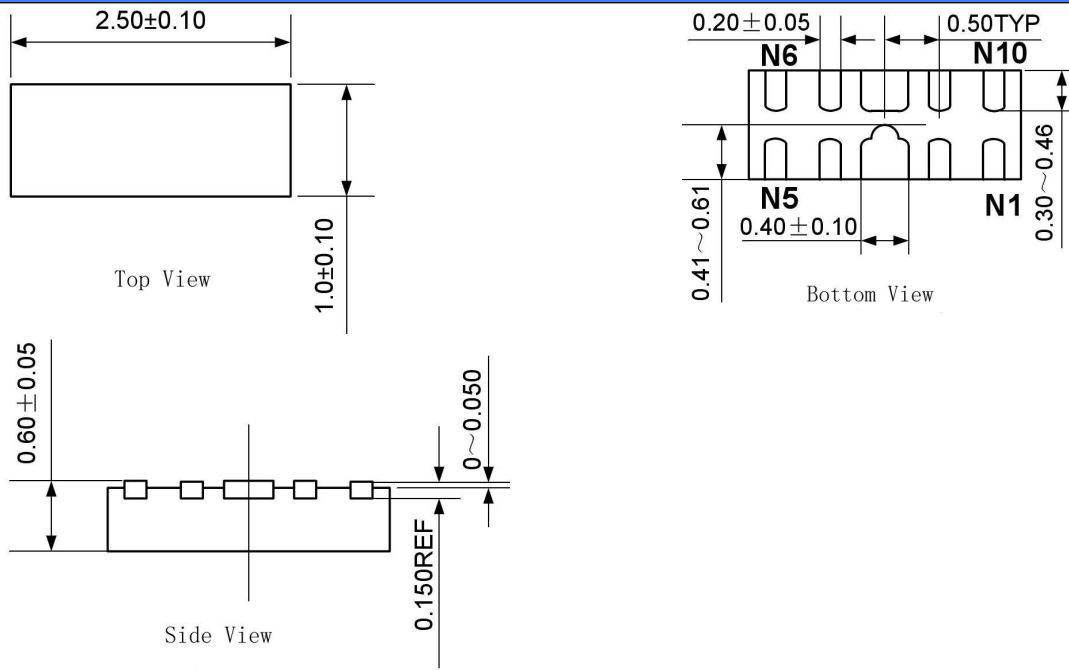

Figure 5- Insertion Loss



DFN-10-2.5*1.0*0.6-0.5 (1)



DFN-10-2.5*1.0*0.6-0.5 (2)

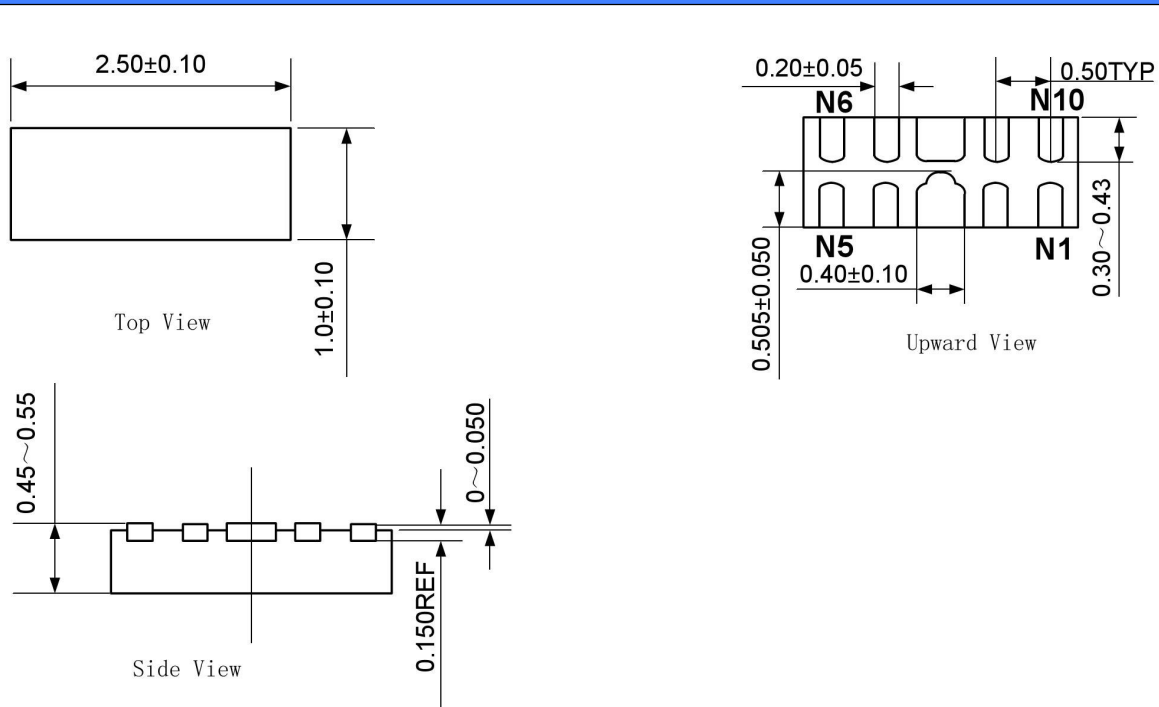

Ordering Information

PART NUMBER	Package	Min. Order Qty.
ESD0524P	DFN-10-2.5*1.0*0.6-0.5	3000pcs