

## Transient Voltage Suppressors for ESD Protection

### ESDXXV32D-A Series

#### Description

The ESDXXV32D-A is designed to protect voltage sensitive components from ESD and transient voltage events. Excellent clamping capability, low leakage, and fast response time, make these parts ideal for ESD protection on designs where board space is at a premium. Because of its small size, it is suited for use in cellular phones, MP3 players, digital cameras and many other portable applications where board space is at a premium.

SOD-323

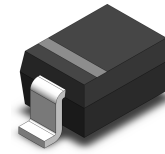

#### Feature

- u 320 Watts Peak Pulse Power per Line (tp=8/20µs)
- u Protects one I/O line or power line
- u Low clamping voltage
- u Working voltages : 3.3V, 5V, 8V, 12V, 15V,24V and 36V
- u Low leakage current
- u IEC61000-4-2 (ESD) ±15kV (air), ±8kV (contact)
- u IEC61000-4-4 (EFT) 40A (5/50ns)
- u IEC61000-4-5 (Lightning) 24A (8/20µs)

#### Functional Diagram

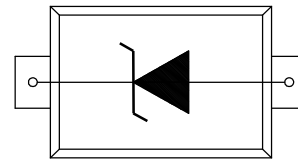

#### Applications

- u Cell Phone Handsets and Accessories
- u Microprocessor based equipment
- u Personal Digital Assistants (PDA's)
- u Notebooks, Desktops, and Servers
- u Portable Instrumentation
- u Peripherals
- u Pagers

#### Mechanical Characteristics

- u JEDEC SOD-323 Package
- u Molding Compound Flammability Rating : UL 94V-0
- u Weight 5 Milligrams (Approximate)
- u Quantity Per Reel : 3,000pcs
- u Reel Size : 7 inch
- u Lead Finish : Lead Free

#### Mechanical Characteristics

Symbol	Parameter	Value	Units
P <sub>PP</sub>	Peak Pulse Power (tp=8/20µs waveform)	320	W
T <sub>L</sub>	Lead Soldering Temperature	260 (10sec)	°C
T <sub>STG</sub>	Storage Temperature Range	-55 to +150	°C
T <sub>J</sub>	Operating Temperature Range	-55 to +150	°C
	IEC61000-4-2 (ESD)	Air Discharge ±15 Contact Discharge ±8	KV
	IEC61000-4-4 (EFT)	40	A
	IEC61000-4-5 ( Lightning )	24	A

# Transient Voltage Suppressors for ESD Protection

## ESDXXV32D-A Series

### I-V Curve Characteristics

Symbol	Parameter
$I_{PP}$	Maximum Reverse Peak Pulse Current
$V_C$	Clamping Voltage @ $I_{PP}$
$V_{RWM}$	Working Peak Reverse Voltage
$I_R$	Maximum Reverse leakage Current @ $V_{RWM}$
$I_T$	Test Current
$V_B$	Breakdown Voltage @ $I_T$
$I_F$	Forward Current
$V_F$	Forward Voltage @ $I_F$
$P_{PK}$	Peak Power Dissipation
$C$	Max Capacitance @ $V_R=0V$ & $f=1MHz$

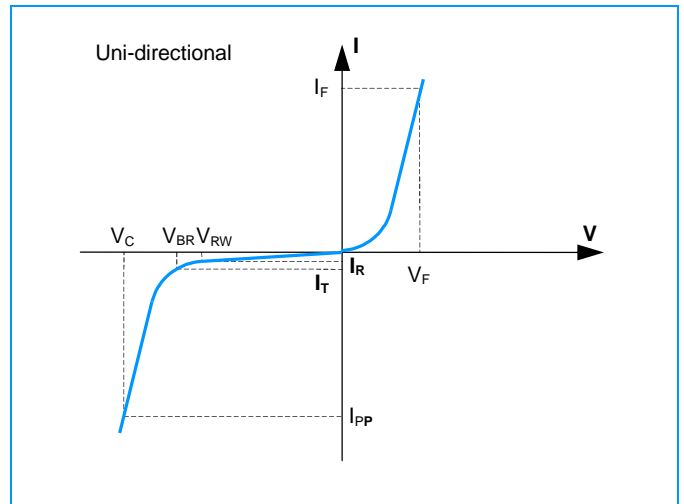

### Electrical Characteristics (@ 25°C Unless Otherwise Specified)

Part Number	Device Marking	$V_{RWM}$ (V) (Max.)	$V_B$ (V) (Min.)	$I_T$ (mA)	$V_C$ @1A (Max.)	$V_C$		$I_R$ ( $\mu A$ ) (Max.)	$C$ (pF) (Typ.)
						(Max.)	(@A)		
ESD3.3V32D-A	03W	3.3	4.0	1	6.5	10.9	30	40	500
ESD05V32D-A	05W	5	6.0	1	9.8	13.5	24	10	350
ESD08V32D-A	08W	8	8.5	1	13.4	21	18	10	150
ESD12V32D-A	12W	12	13.3	1	19	25.9	15	1	120
ESD15V32D-A	15W	15	16.7	1	24	30	12	1	100
ESD24V32D-A	24W	24	26.7	1	43	48	8	1	80
ESD36V32D-A	36W	36	40.0	1	60	75	5	1	30

### Characteristic Curves

Fig1. 8/20 $\mu s$  Pulse Waveform

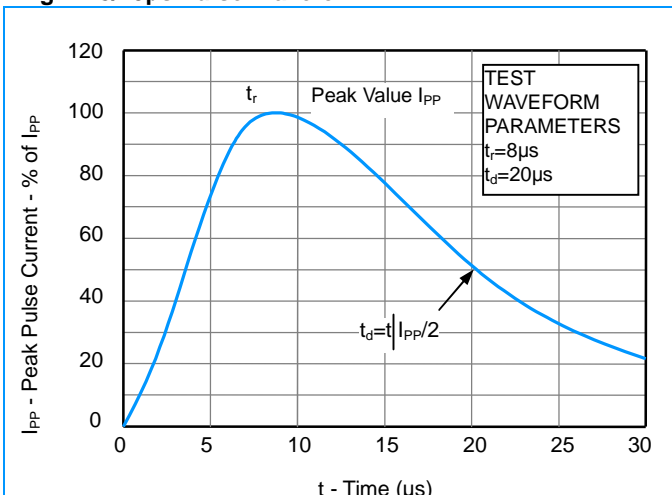
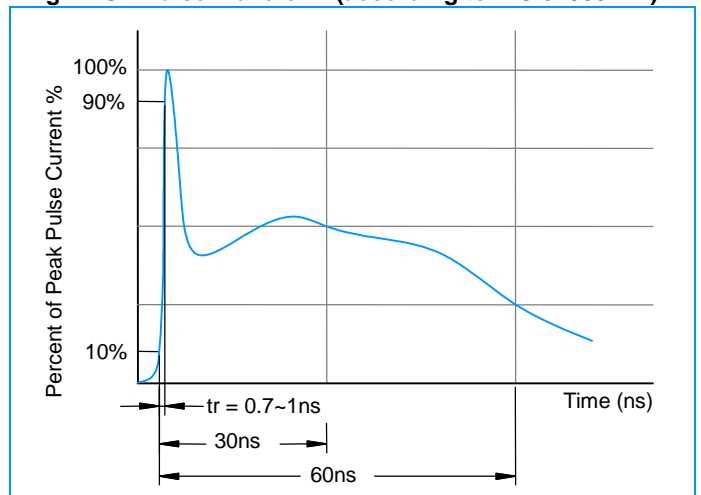

Fig2. ESD Pulse Waveform (according to IEC 61000-4-2)



# Transient Voltage Suppressors for ESD Protection

## ESDXXV32D-A Series

### Characteristic Curves

**Fig3. ESD Clamping (+8KV Contac per IEC61000-4-2)**

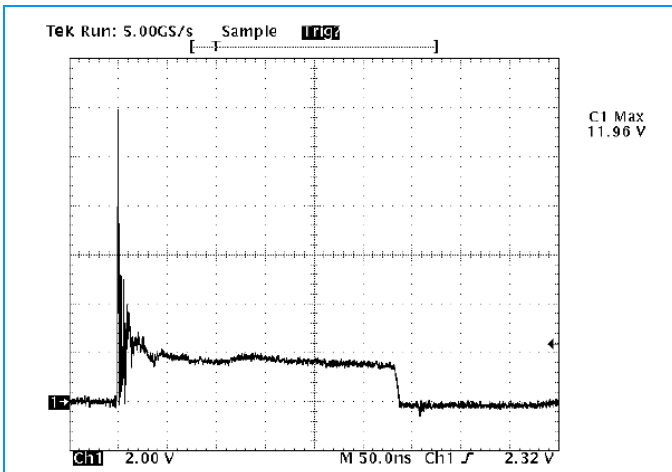

**Fig4. ESD Clamping (-8KV Contac per IEC61000-4-2)**

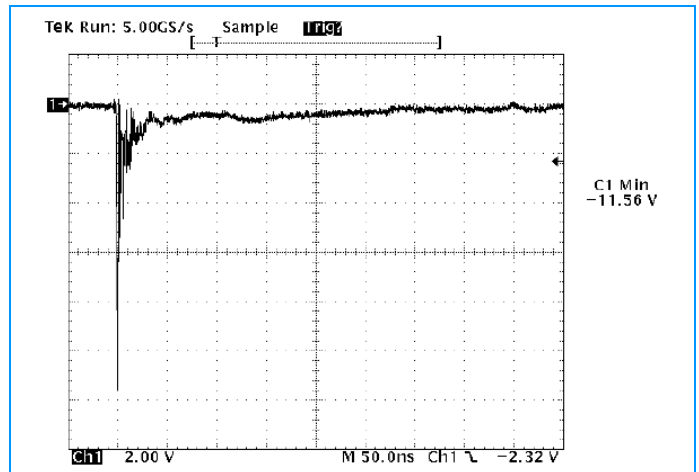

### SOD-323 Package Outline & Dimensions

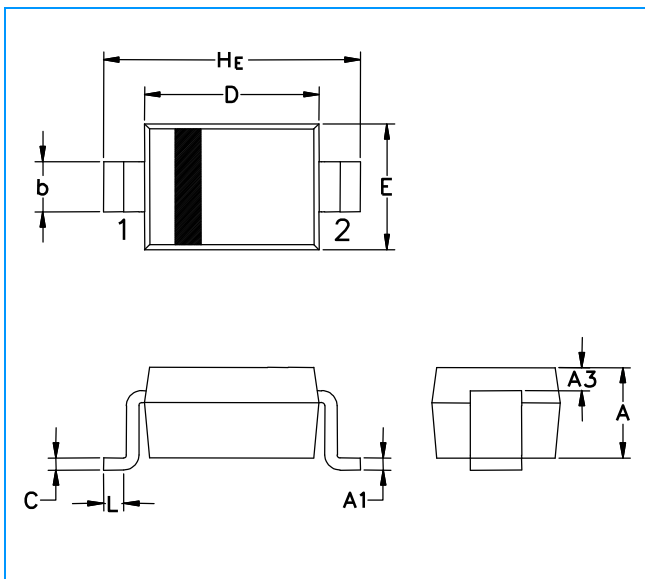

Symbol	Millimeters			Inches		
	Min.	Nom.	Max.	Min.	Nom.	Max.
A	0.80	0.90	1.00	0.031	0.035	0.040
A1	0.00	0.05	0.10	0.000	0.002	0.004
A3	0.15 REF			0.006 REF		
b	0.25	0.32	0.40	0.010	0.012	0.016
C	0.089	0.12	0.177	0.003	0.005	0.007
D	1.60	1.70	1.80	0.062	0.066	0.070
E	1.15	1.25	1.35	0.045	0.049	0.053
L	0.08			0.003		
HE	2.30	2.50	2.70	0.090	0.098	0.105

### Soldering Footprint

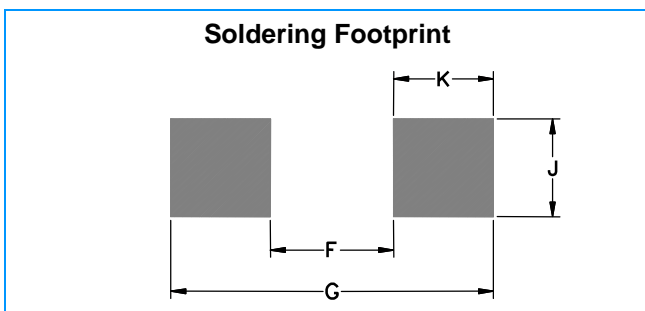

Symbol	Millimeters	Inches
F	1.60	0.063
G	2.85	0.112
J	0.83	0.033
K	0.63	0.025