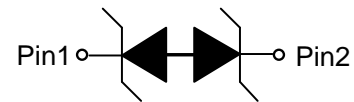

ESD5651N
4.5V, Single Li-ion Battery Port Surge Protector
<http://www.sh-willsemi.com>
Descriptions

The ESD5651N is a bi-directional TVS (Transient Voltage Suppressor). It is specifically designed to protect sensitive electronic components which are connected to power lines, from over-stress caused by ESD (Electrostatic Discharge), EFT (Electrical Fast Transients) and Lightning.

The ESD5651N may be used to provide ESD protection up to $\pm 30\text{kV}$ (contact and air discharge) according to IEC61000-4-2, and withstand peak pulse current up to 30A (8/20 μs) according to IEC61000-4-5.

The ESD5651N is available in DFN1006-2L package. Standard products are Pb-free and Halogen-free.

DFN1006-2L (Bottom View)

Circuit diagram
Features

- Reverse stand-off voltage: $\pm 4.5\text{V}$ Max.
- Transient protection for each line according to IEC61000-4-2 (ESD): $\pm 30\text{kV}$ (contact and air discharge)
IEC61000-4-4 (EFT): 40A (5/50ns)
IEC61000-4-5 (surge): 30A (8/20 μs)
- Capacitance: $C_J = 65\text{pF}$ typ.
- Low leakage current
- Low clamping voltage: $V_{CL} = 6.5\text{V}$ typ. @ $I_{PP} = 16\text{A}$ (TLP)
- Solid-state silicon technology



3 = Device code

* = Month code (A~Z)

Marking (Top View)
Applications

- Power lines
- Cellular handsets
- Tablets
- Microprocessors
- Portable Electronics

Order information

Device	Package	Shipping
ESD5651N-2/TR	DFN1006-2L	10000/Tape&Reel

Absolute maximum ratings

Parameter	Symbol	Rating	Unit
Peak pulse power ($t_p = 8/20\mu s$)	P_{pk}	420	W
Peak pulse current ($t_p = 8/20\mu s$)	I_{PP}	30	A
ESD according to IEC61000-4-2 air discharge	V_{ESD}	± 30	kV
ESD according to IEC61000-4-2 contact discharge		± 30	
Junction temperature	T_J	125	$^{\circ}C$
Operating temperature	T_{OP}	-40~85	$^{\circ}C$
Lead temperature	T_L	260	$^{\circ}C$
Storage temperature	T_{STG}	-55~150	$^{\circ}C$

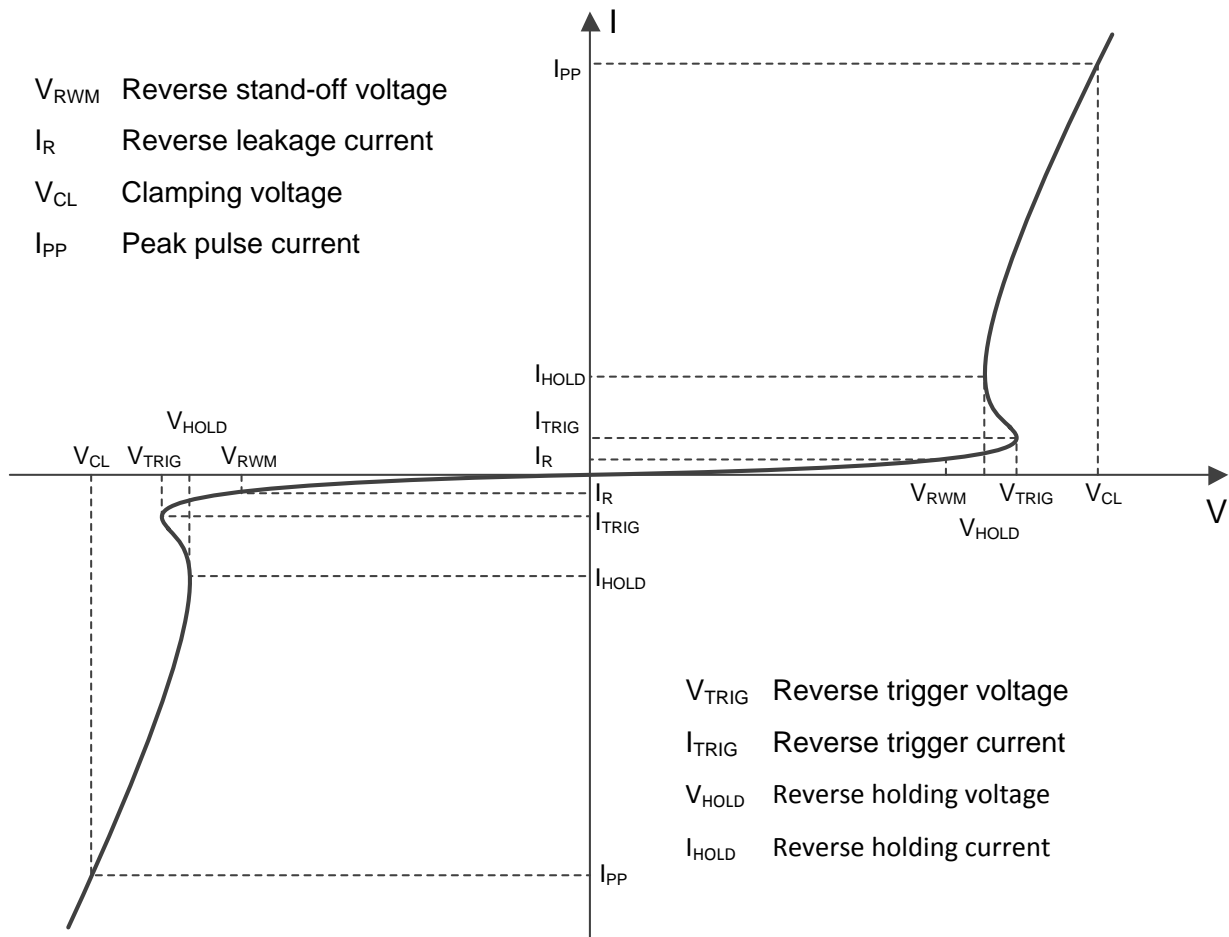
Electrical characteristics ($T_A=25^{\circ}C$, unless otherwise noted)

Definitions of electrical characteristics

Electrical characteristics (T_A=25 °C, unless otherwise noted)

Parameter	Symbol	Condition	Min.	Typ.	Max.	Unit
Reverse stand-off voltage	V _{RWM}				±4.5	V
Reverse leakage current	I _R	V _{RWM} = 4.5V			1	μA
Reverse trigger voltage	V _{TRIG}	I _{TRIG} = 2μA	4.7			V
Reverse holding voltage	V _{HOLD}	I _{HOLD} = 50mA	4.6			V
Clamping voltage ¹⁾	V _{CL}	I _{PP} = 16A, t _p = 100ns		6.5		V
Clamping voltage ²⁾	V _{CL}	V _{ESD} = 8kV		6.5		V
Clamping voltage ³⁾	V _{CL}	I _{PP} = 1A, t _p = 8/20μs			6	V
		I _{PP} = 20A, t _p = 8/20μs			11	V
		I _{PP} = 30A, t _p = 8/20μs			14	V
Dynamic resistance ¹⁾	R _{DYN}			0.12		Ω
Junction capacitance	C _J	V _R = 0V, f = 1MHz		65	80	pF
		V _R = 4.5V, f = 1MHz		45	60	pF

Notes:

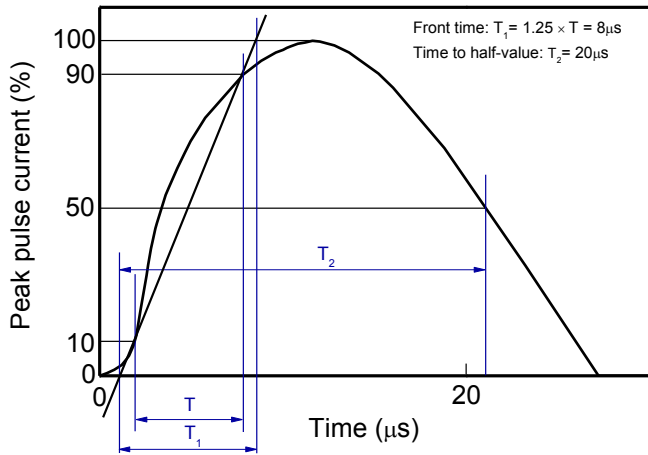
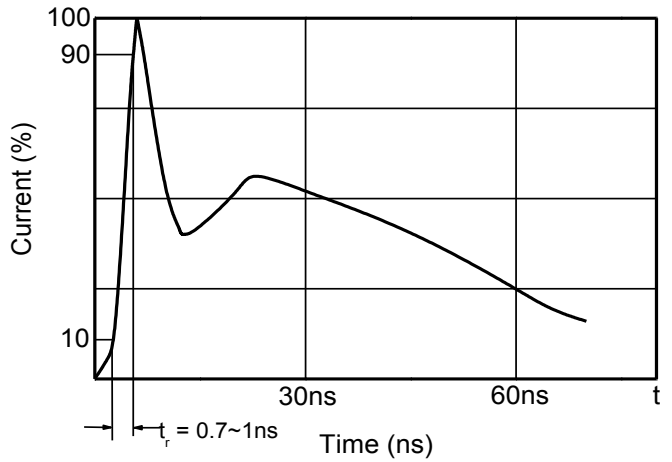
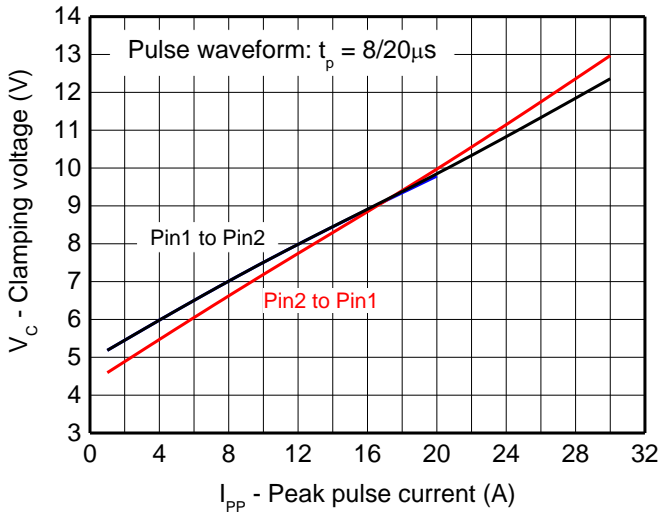
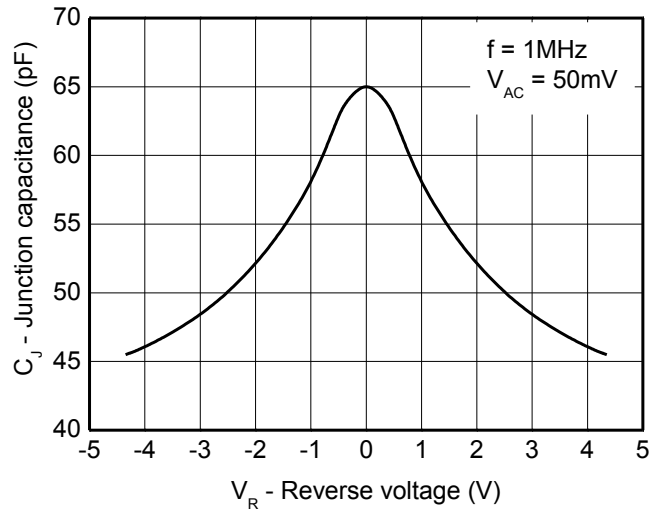
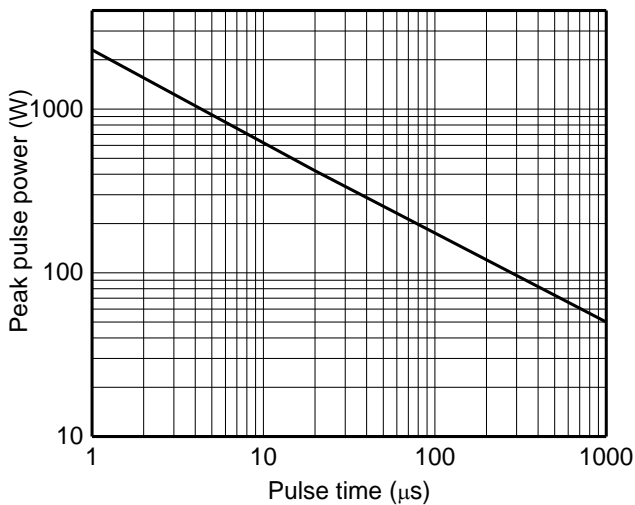
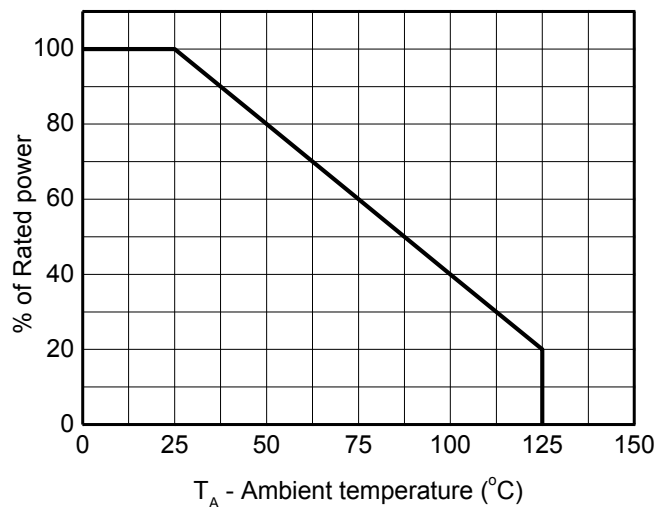
- 1) TLP parameter: Z₀ = 50Ω, t_p = 100ns, t_r = 2ns, averaging window from 60ns to 80ns. R_{DYN} is calculated from 4A to 16A.
- 2) Contact discharge mode, according to IEC61000-4-2.
- 3) Non-repetitive current pulse, according to IEC61000-4-5.

Typical characteristics ($T_A=25^\circ\text{C}$, unless otherwise noted)

8/20 μs waveform per IEC61000-4-5

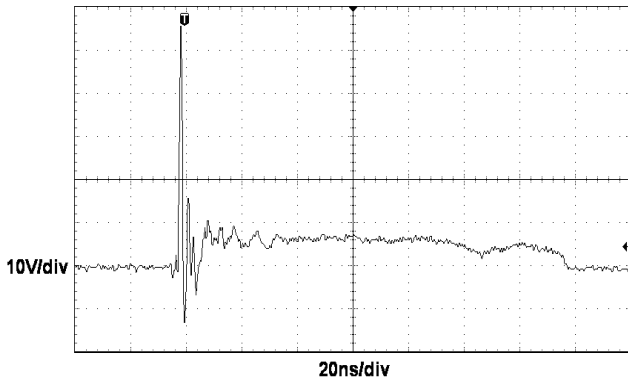
Contact discharge current waveform per IEC61000-4-2

Clamping voltage vs. Peak pulse current

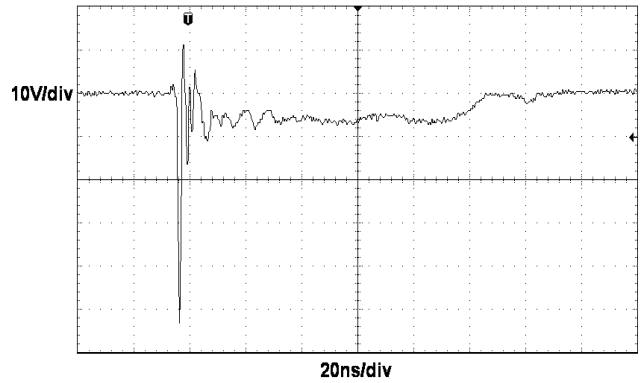
Capacitance vs. Reverse voltage

Non-repetitive peak pulse power vs. Pulse time

Power derating vs. Ambient temperature

Typical characteristics ($T_A=25^{\circ}\text{C}$, unless otherwise noted)



ESD clamping
(+8kV contact discharge per IEC61000-4-2)



ESD clamping
(-8kV contact discharge per IEC61000-4-2)

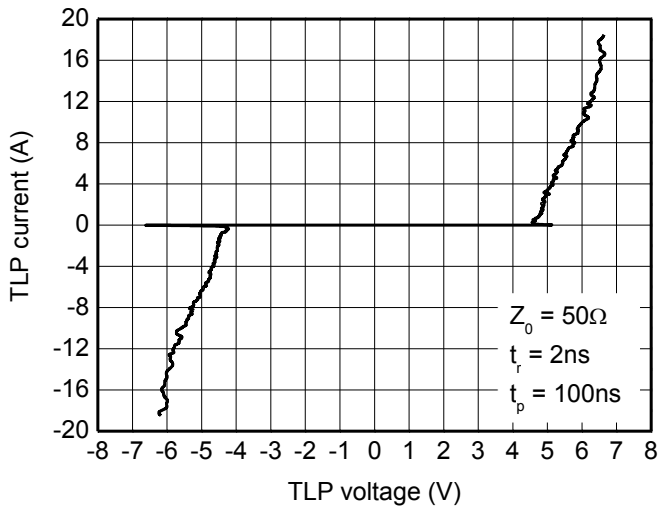

TLP Measurement

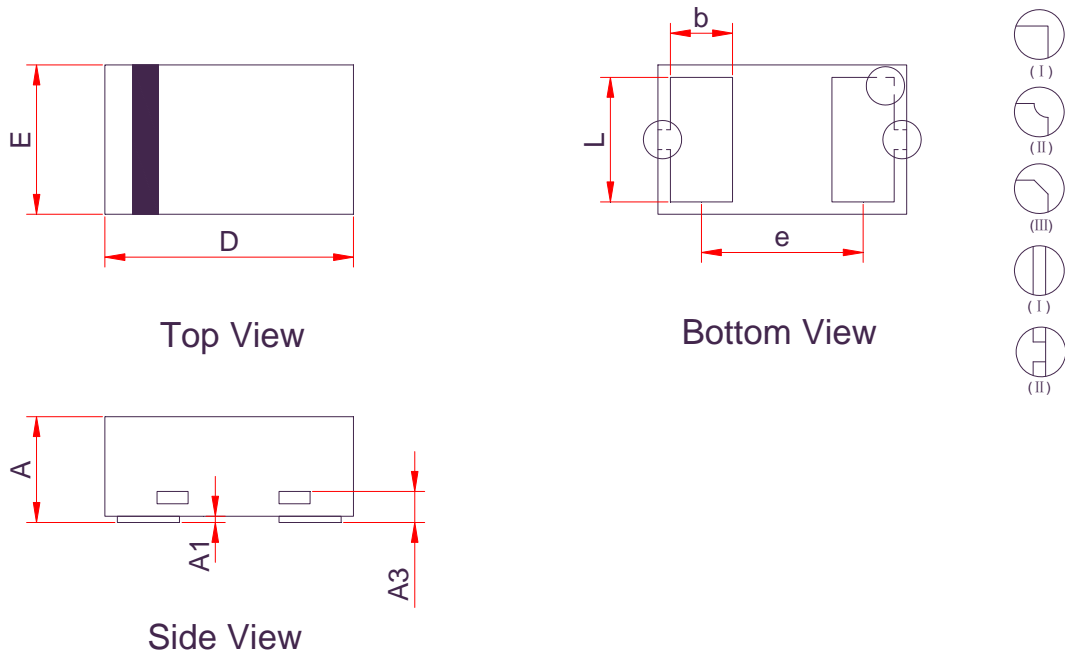
PACKAGE OUTLINE DIMENSIONS
DFN1006-2L

Symbol	Dimensions in Millimeters		
	Min.	Typ.	Max.
A	0.34	0.45	0.53
A1	0.00	0.02	0.05
A3	0.12 Ref.		
D	0.95	1.00	1.08
E	0.55	0.60	0.68
b	0.20	0.25	0.30
L	0.45	0.50	0.55
e	0.65 BSC		

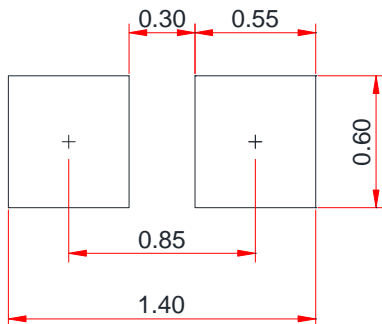
Recommended land pattern (Unit: mm)

Notes:

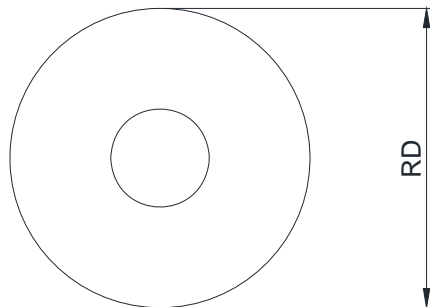
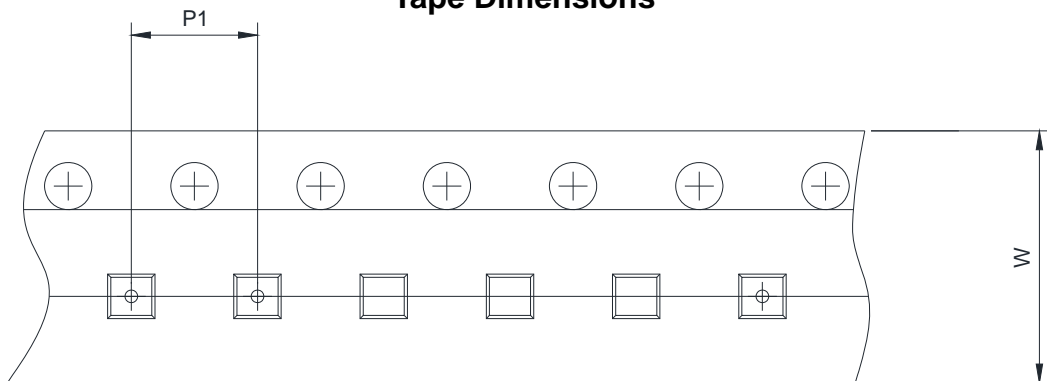
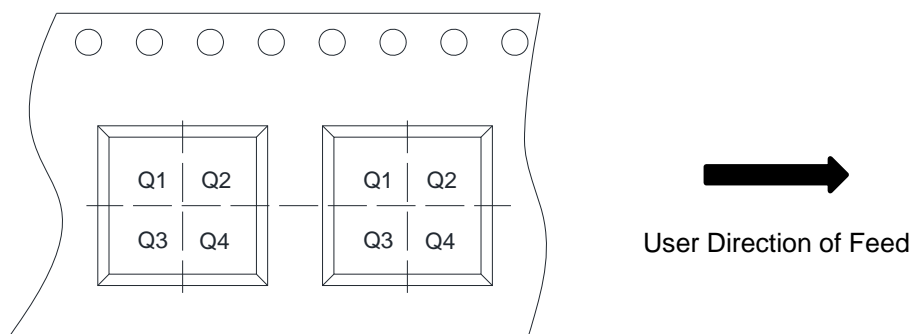
This recommended land pattern is for reference purposes only. Please consult your manufacturing group to ensure your PCB design guidelines are met.

TAPE AND REEL INFORMATION
Reel Dimensions

Tape Dimensions

Quadrant Assignments For PIN1 Orientation In Tape

RD	Reel Dimension	<input checked="" type="checkbox"/> 7inch	<input type="checkbox"/> 13inch
W	Overall width of the carrier tape	<input checked="" type="checkbox"/> 8mm	<input type="checkbox"/> 12mm <input type="checkbox"/> 16mm
P1	Pitch between successive cavity centers	<input checked="" type="checkbox"/> 2mm	<input type="checkbox"/> 4mm <input type="checkbox"/> 8mm
Pin1	Pin1 Quadrant	<input checked="" type="checkbox"/> Q1	<input checked="" type="checkbox"/> Q2 <input type="checkbox"/> Q3 <input type="checkbox"/> Q4