

# Transient Voltage Suppressors Array for ESD Protection

## ESDXXV26T-5L Series

### Description

The ESDXXV26T-5L is designed to protect voltage sensitive components from ESD and transient voltage events. Excellent clamping capability, low leakage, and fast response time, make these parts ideal for ESD protection on designs where board space is at a premium.

SOT-26

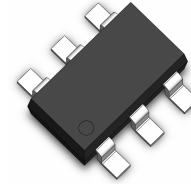

### Feature

- u 350 Watts Peak Pulse Power per Line (tp=8/20µs)
- u Protects four or five directional I/O lines
- u Low clamping voltage
- u Working voltages : 5V, 12V, 15V and 24V
- u Low leakage current
- u IEC61000-4-2 (ESD) ±15kV (air), ±8kV (contact)
- u IEC61000-4-4 (EFT) 40A (5/50ns)
- u IEC61000-4-5 (Lightning) 12A (8/20µs)

### Functional Diagram

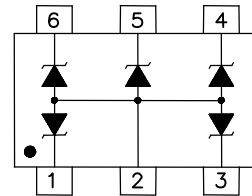

### Applications

- u RS-232, RS-422 & RS-423 Data Lines
- u Audio/Video Inputs
- u Wireless Network Systems
- u Digit Video Interface (DVI)
- u Medical Sensors
- u Notebook Computers

### Mechanical Characteristics

- u JEDEC SOT-26 Package
- u Molding Compound Flammability Rating : UL 94V-0
- u Weight 14.0 Milligrams (Approximate)
- u Quantity Per Reel : 3,000pcs
- u Reel Size : 7 inch
- u Lead Finish : Lead Free

### Mechanical Characteristics

Symbol	Parameter	Value	Units
P <sub>PP</sub>	Peak Pulse Power (tp=8/20µs waveform)	350	W
T <sub>L</sub>	Lead Soldering Temperature	260 (10sec)	°C
T <sub>STG</sub>	Storage Temperature Range	-55 to +150	°C
T <sub>J</sub>	Operating Temperature Range	-55 to +150	°C
	IEC61000-4-2 (ESD)	Air Discharge ±15 Contact Discharge ±8	KV
	IEC61000-4-4 (EFT)	40	A
	IEC61000-4-5 ( Lightning )	12	A

# Transient Voltage Suppressors Array for ESD Protection

## ESDXXV26T-5L Series

Electrical Characteristics (@ 25°C Unless Otherwise Specified)

Part Number	Device Marking	V <sub>RWM</sub> (V) (Max.)	V <sub>B</sub> (V) (Min.)	I <sub>T</sub> (mA)	V <sub>C</sub> @1A (Max.)	V <sub>C</sub>		I <sub>R</sub> (μA) (Max.)	C (pF) (Typ.)
						(Max.)	(@A)		
ESD3.3V26T-5L	TC3	3.3	4.5	1	7.5	14.0	25	5	250
ESD05V26T-5L	TC5	5.0	6.0	1	9.8	15.0	24	5	200
ESD12V26T-5L	TCH	12.0	13.3	1	19.0	27.0	15	1	90
ESD15V26T-5L	TCJ	15.0	16.7	1	24.0	30.0	12	1	70
ESD24V26T-5L	TCK	24.0	26.7	1	38.0	46.0	8	1	50

### Characteristic Curves

Fig1. 8/20μs Pulse Waveform

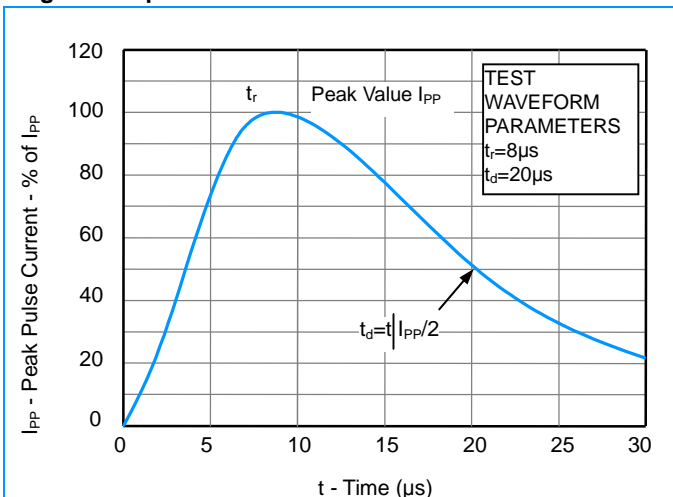

Fig2. ESD Pulse Waveform (according to IEC 61000-4-2)

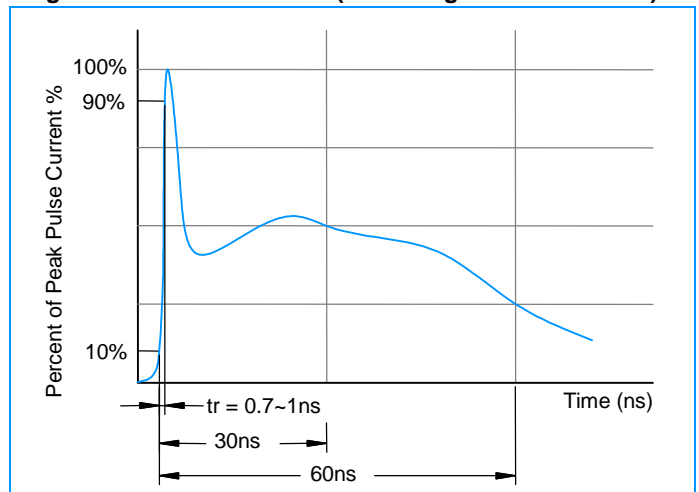

Fig3. ESD Clamping (+8KV Contac per IEC61000-4-2)

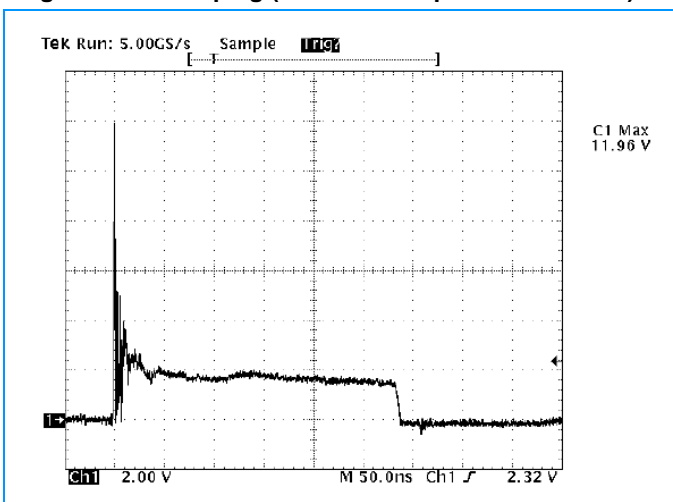
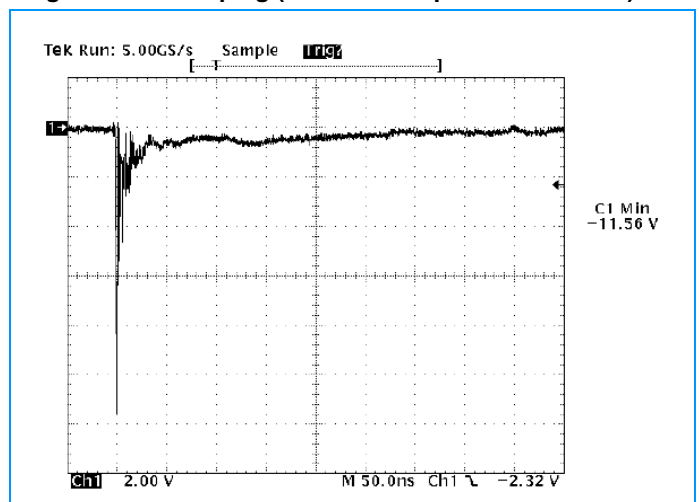

Fig4. ESD Clamping (-8KV Contac per IEC61000-4-2)



# Transient Voltage Suppressors Array for ESD Protection

## ESDXXV26T-5L Series

### SOT-26 Package Outline & Dimensions

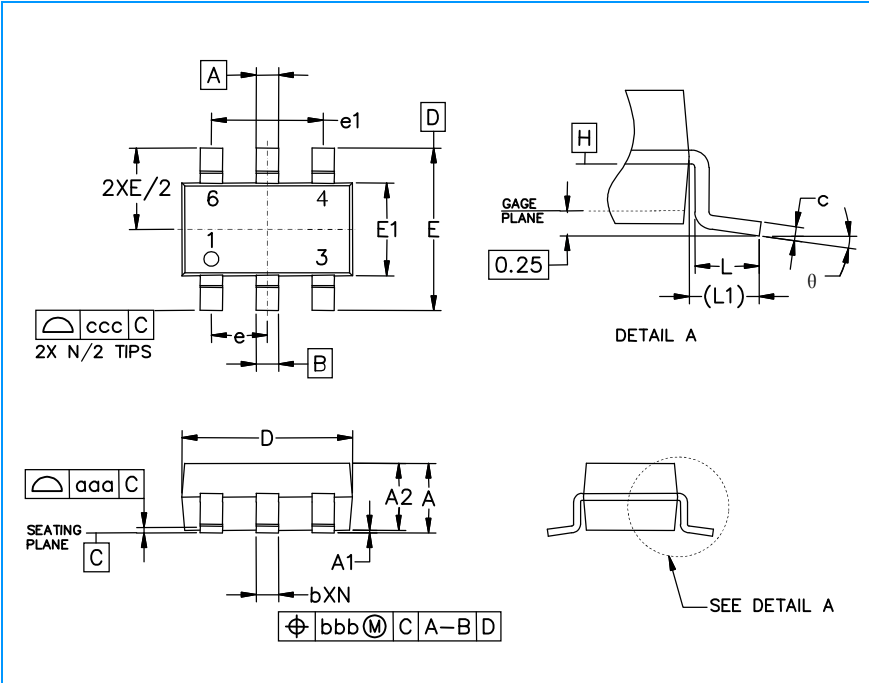

Symbol	Inches			Millimeters		
	Min.	Nom.	Max.	Min.	Nom.	Max.
A	0.035	-	0.057	0.90	-	1.45
A1	0.000	-	0.006	0.00	-	0.15
A2	0.035	0.045	0.051	0.90	1.15	1.30
b	0.010	-	0.020	0.25	-	0.50
c	0.003	-	0.009	0.08	-	0.22
D	0.110	0.114	0.122	2.80	2.90	3.10
E1	0.060	0.063	0.069	1.50	1.60	1.75
E	0.110 BSC			2.80 BSC		
e	0.037 BSC			0.95 BSC		
e1	0.075 BSC			1.90 BSC		
L	0.012	0.018	0.024	0.30	0.45	0.60
L1	(0.024)			(0.60)		
theta	0°	-	10°	0°	-	10°
aaa	0.004			0.10		
bbb	0.008			0.20		
ccc	0.008			0.20		

### Soldering Footprint

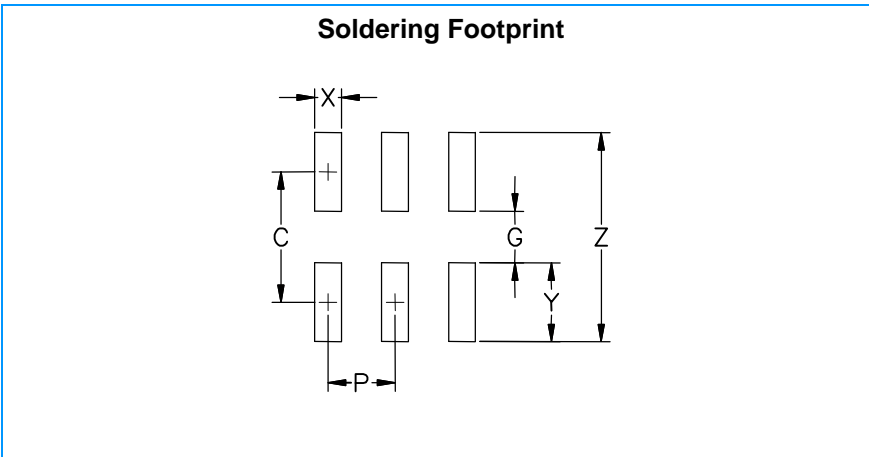

Symbol	Inches	Millimeters
C	(0.098)	(2.50)
G	0.055	1.40
P	0.037	0.95
X	0.024	0.60
Y	0.043	1.10
Z	0.141	3.60