

FR801 THRU FR806

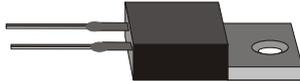

8.0 AMP FAST RECOVERY RECTIFIERS



FEATURES

- * Low forward voltage drop
- * High current capability
- * High reliability
- * High surge current capability

MECHANICAL DATA

- * Case: Molded plastic
- * Epoxy: UL 94V-0 rate flame retardant
- * Lead: Lead solderable per MIL-STD-202, method 208 guaranteed
- * Polarity: As Marked
- * Mounting position: Any
- * Weight: 2.24 grams

VOLTAGE RANGE

50 to 800 Volts

CURRENT

8.0 Amperes

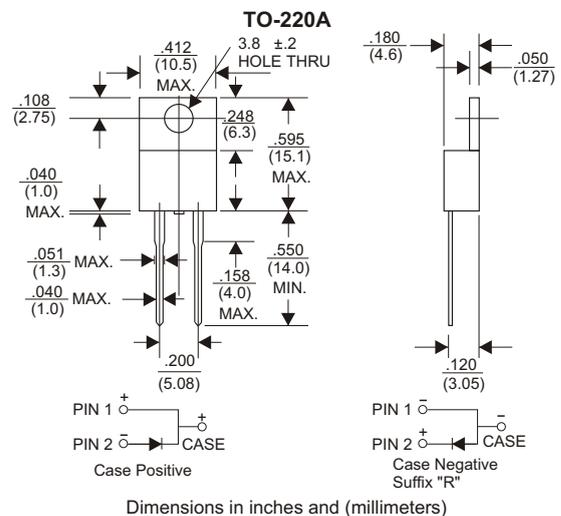

MAXIMUM RATINGS AND ELECTRICAL CHARACTERISTICS

Rating 25°C ambient temperature unless otherwise specified.
Single phase half wave, 60Hz, resistive or inductive load.
For capacitive load, derate current by 20%.

TYPE NUMBER	FR801	FR802	FR803	FR804	FR805	FR806	UNITS
Maximum Recurrent Peak Reverse Voltage	50	100	200	400	600	800	V
Maximum RMS Voltage	35	70	140	280	420	560	V
Maximum DC Blocking Voltage	50	100	200	400	600	800	V
Maximum Average Forward Rectified Current							
.375"(9.5mm) Lead Length at Tc=75°C	8.0						A
Peak Forward Surge Current, 8.3 ms single half sine-wave superimposed on rated load (JEDEC method)	200						A
Maximum Instantaneous Forward Voltage at 8.0A	1.3						V
Maximum DC Reverse Current Tc=25°C	10.0						μA
at Rated DC Blocking Voltage Tc=100°C	200						μA
Maximum Reverse Recovery Time (Note 1)	150			250		500	nS
Typical Junction Capacitance (Note 2)	65						pF
Operating and Storage Temperature Range Tj, Tstg	-65 — +150						°C

NOTES:

1. Reverse Recovery Time test condition: IF=0.5A, IR=1.0A, IRR=0.25A
2. Measured at 1MHz and applied reverse voltage of 4.0V D.C.

RATING AND CHARACTERISTIC CURVES (FR801 THRU FR806)

FIG.1-TYPICAL FORWARD CHARACTERISTICS

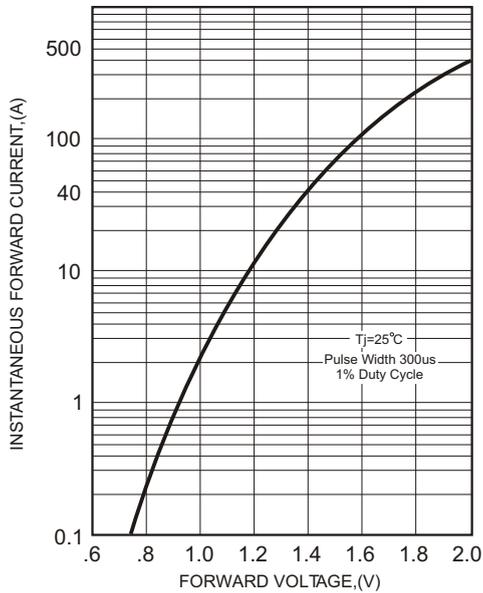

FIG.2-TYPICAL FORWARD CURRENT DERATING CURVE

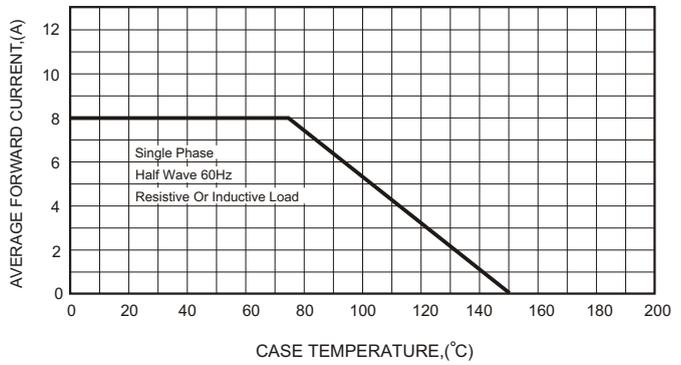
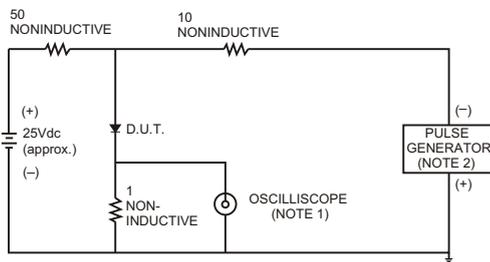

FIG.3- TEST CIRCUIT DIAGRAM AND REVERSE RECOVERY TIME CHARACTERISTICS



NOTES: 1. Rise Time= 7ns max., Input Impedance= 1 megohm, 22pF.
2. Rise Time= 10ns max., Source Impedance= 50 ohms.

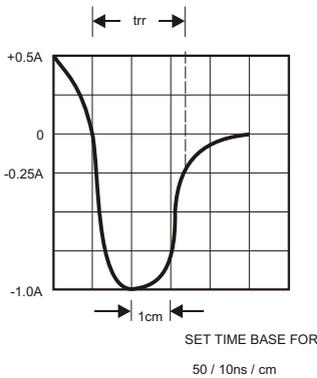

FIG.4-MAXIMUM NON-REPETITIVE FORWARD SURGE CURRENT

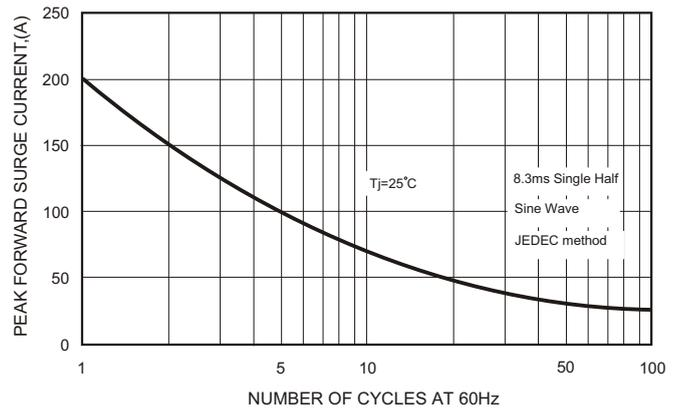

FIG.5-TYPICAL JUNCTION CAPACITANCE

