



1.0 Key Features

- Three on-chip PLLs with programmable reference and feedback dividers
- Four independently programmable muxes and post dividers
- I²C™-bus serial interface
- Programmable power-down of all PLLs and output clock drivers
- One PLL and two mux/post-divider combinations can be modified by SEL_CD input
- Tristate outputs for board testing
- 5V to 3.3V operation
- Accepts 5MHz to 27MHz crystal resonators
- Commercial and industrial temperature ranges offered

2.0 General Description

The FS6377 is a CMOS clock generator IC designed to minimize cost and component count in a variety of electronic systems. Three I²C-programmable phase locked loops (PLLs) feeding four programmable muxes and post dividers provide a high degree of flexibility.

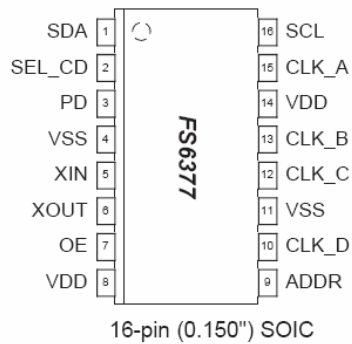

Figure 1: Pin Configuration

FS6377

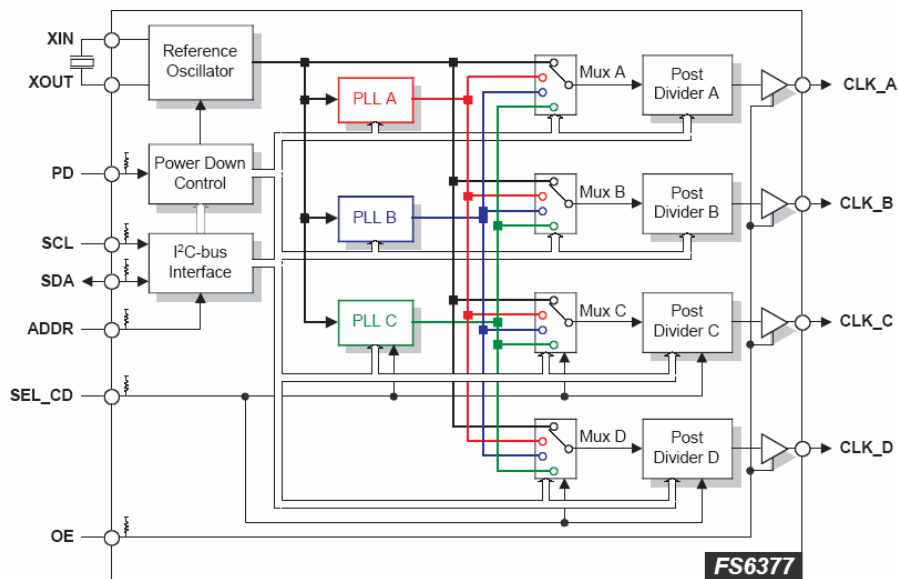

Figure 2: Block Diagram

Table 1: Pin Descriptions

Pin	Type	Name	Description
1	DI ^U O	SDA	Serial interface data input/output
2	DI ^U	SEL_CD	Selects one of two PLL C, mux D/C and post divider C/D combinations
3	DI ^U	PD	Power-down input
4	P	VSS	Ground
5	AI	XIN	Crystal oscillator input
6	AO	XOUT	Crystal oscillator output
7	DI ^U	OE	Output enable input
8	P	VDD	Power supply (5V to 3.3V)
9	DI ^U	ADDR	Address select
10	DO	CLK_D	D clock output
11	P	VSS	Ground
12	DO	CLK_C	C clock output
13	DO	CLK_B	B clock output
14	P	VDD	Power supply (5V to 3.3V)
15	DO	CLK_A	A clock output
16	DI ^U	SCL	Serial interface clock output

Key: AI: Analog Input; AO = Analog Output; DI = Digital Input; DI^U = Input with Internal Pull-up; DI^D = Input with Internal Pull-down; DIO = Digital Input/Output; DI-3 = Three-level Digital Input; DO = Digital Output; P = Power/Ground; # = Active Low Pin

3.0 Functional Block Description

3.1 Phase Locked Loops (PLLs)

Each of the three on-chip PLLs is a standard phase- and frequency-locked loop architecture that multiplies a reference frequency to a desired frequency by a ratio of integers. This frequency multiplication is exact.

As shown in Figure 3, each PLL consists of a reference divider, a phase-frequency detector (PFD), a charge pump, an internal loop filter, a voltage-controlled oscillator (VCO), and a feedback divider.

During operation, the reference frequency (f_{REF}), generated by the on-board crystal oscillator, is first reduced by the reference divider. The divider value is called the "modulus," and is denoted as N_R for the reference divider. The divided reference is then fed into the PFD.

The PFD controls the frequency of the VCO (f_{VCO}) through the charge pump and loop filter. The VCO provides a high speed, low noise, continuously variable frequency clock source for the PLL. The output of the VCO is fed back to the PFD through the feedback divider (the modulus is denoted by N_F) to close the loop.

The PFD will drive the VCO up or down in frequency until the divided reference frequency and the divided VCO frequency appearing at the inputs of the PFD are equal. The input/output relationship between the reference frequency and the VCO frequency is:

$$f_{VCO} = f_{REF} \left(\frac{N_F}{N_R} \right)$$

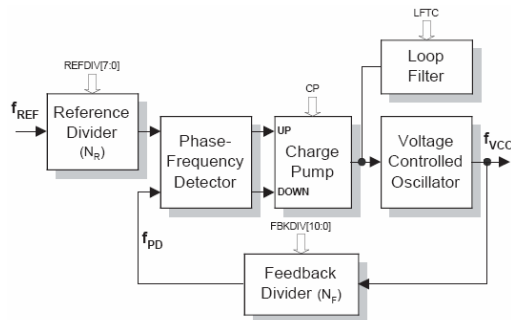

Figure 3: PLL Diagram

3.1.1. Reference Divider

The reference divider is designed for low phase jitter. The divider accepts the output of the reference oscillator and provides a divided-down frequency to the PFD. The reference divider is an 8-bit divider, and can be programmed for any modulus from 1 to 255 by programming the equivalent binary value. A divide-by-256 can also be achieved by programming the eight bits to 00h.

3.1.2. Feedback Divider

The feedback divider is based on a dual-modulus prescaler technique. The technique allows the same granularity as a fully programmable feedback divider, while still allowing the programmable portion to operate at low speed. A high-speed pre-divider (also called a prescaler) is placed between the VCO and the programmable feedback divider because of the high speeds at which the VCO can operate. The dual-modulus technique insures reliable operation at any speed that the VCO can achieve and reduces the overall power consumption of the divider.

FS6377

For example, a fixed divide-by-eight could be used in the feedback divider. Unfortunately, a divide-by-eight would limit the effective modulus of the entire feedback divider to multiples of eight. This limitation would restrict the ability of the PLL to achieve a desired input-frequency-to-output frequency ratio without making both the reference and feedback divider values comparatively large.

A large feedback modulus means that the divided VCO frequency is relatively low, requiring a wide loop bandwidth to permit the low frequencies. A narrow loop bandwidth tuned to high frequencies is essential to minimizing jitter; therefore, divider moduli should always be as small as possible.

To understand the operation, refer to Figure 4. The M-counter (with a modulus always equal to M) is cascaded with the dual-modulus prescaler. The A-counter controls the modulus of the prescaler. If the value programmed into the A-counter is A, the prescaler will be set to divide by N+1 for A prescaler outputs. Thereafter, the prescaler divides by N until the M-counter output resets the A-counter, and the cycle begins again. Note that N=8 and A and M are binary numbers.

Suppose that the A-counter is programmed to zero. The modulus of the prescaler will always be fixed at N; and the entire modulus of the feedback divider becomes MxN.

Next, suppose that the A-counter is programmed to a one. This causes the prescaler to switch to a divide-by-N+1 for its first divide cycle and then revert to a divide-by-N. In effect, the A-counter absorbs (or "swallows") one extra clock during the entire cycle of the feedback divider. The overall modulus is now seen to be equal to MxN+1.

This example can be extended to show that the feedback divider modulus is equal to MxN+A, where A<M.

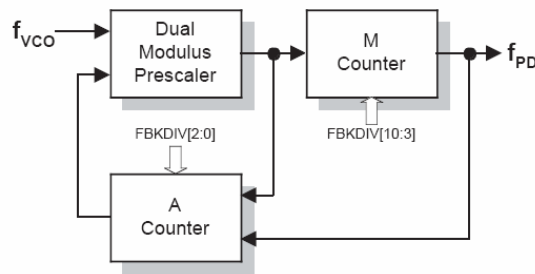

Figure 4: Feedback Divider

3.1.3. Feedback Divider Programming

For proper operation of the feedback divider, the A-counter must be programmed only for values that are less than or equal to the M-counter. Therefore, not all divider moduli below 56 are available for use. The selection of divider values is listed in Table 2.

Above a modulus of 56, the feedback divider can be programmed to any value up to 2047.

Table 2: Feedback Divider Modulus Under 56

M-Counter: FBKDIV[10:3]	A-Counter: FBKDIV[2:0]							
	000	001	010	011	100	101	110	111
0000001	8	9						
0000010	16	17	18					
0000011	24	25	26	27				
0000100	32	33	34	35	36			
0000101	40	41	42	43	44	45		
0000110	48	49	50	51	52	53	54	
0000111	56	57	58	59	60	61	62	63
	Feedback Divider Modulus							

FS6377

3.2 Post Divider Muxes

As shown in Figure 2, an input mux in front of each post divider stage can select from any one of the PLL frequencies or the reference frequency. The frequency selection is done via the I²C-bus.

The input frequency on two of the four muxes (mux C and D in Figure 2) can be changed without reprogramming by a logic-level input on the SEL_CD pin.

3.3 Post Dividers

The post divider performs several useful functions. First, it allows the VCO to be operated in a narrower range of speeds compared to the variety of output clock speeds that the device is required to generate. Second, it changes the basic PLL equation to

$$f_{\text{CLK}} = f_{\text{REF}} \left(\frac{N_F}{N_R} \right) \left(\frac{1}{N_P} \right)$$

where N_F , N_R and N_P are the feedback, reference and post divider moduli respectively, and f_{CLK} and f_{REF} are the output and reference oscillator frequencies. The extra integer in the denominator permits more flexibility in the programming of the loop for many applications where frequencies must be achieved exactly.

The modulus on two of the four post dividers muxes (post dividers C and D in Figure 2) can be altered without reprogramming by a logic level on the SEL_CD pin.

4.0 Device Operation

The FS6377 powers up with all internal registers cleared to zero, delivering the crystal frequency to all outputs. For operation to occur, the registers must be loaded in a most significant-bit (MSB) to least-significant-bit (LSB) order. The register mapping of the FS6377 is shown in Table 3, and I²C-bus programming information is detailed in Section 5.0.

Control of the reference, feedback and post dividers is detailed in Table 5. Selection of these dividers directly controls how fast the VCO will run. The maximum VCO speed is noted in Table 13.

4.1 SEL_CD Input

The SEL_CD pin provides a way to alter the operation of PLL C, muxes C and D and post dividers C and D without having to reprogram the device. A logic-low on the SEL_CD pin selects the control bits with a "C1" or "D1" notation, per Table 3. A logic-high on the SEL_CD pin selects the control bits with "C2" or "D2" notation, per Table 3.

Note that changing between two running frequencies using the SEL_CD pin may produce glitches in the output, especially if the post-divider(s) is/are altered.

4.2 Power-Down and Output Enable

A logic-high on the PD pin powers down only those portions of the FS6377 which have their respective power-down control bits enabled. Note that the PD pin has an internal pull-up.

When a post divider is powered down, the associated output driver is forced low. When all PLLs and post dividers are powered down the crystal oscillator is also powered down. The XIN pin is forced low, and the XOUT pin is pulled high.

A logic-low on the OE pin tristates all output clocks. Note that this pin has an internal pull-up.

FS6377

4.3 Oscillator Overdrive

For applications where an external reference clock is provided (and the crystal oscillator is not required), the reference clock should be connected to XOUT and XIN should be left unconnected (float).

For best results, make sure the reference clock signal is as jitter-free as possible, can drive a 40pF load with fast rise and fall times and can swing rail-to-rail.

If the reference clock is not a rail-to-rail signal, the reference must be AC coupled to XOUT through a 0.01 μ F or 0.1 μ F capacitor. A minimum 1V peak-to-peak signal is required to drive the internal differential oscillator buffer.

5.0 I²C-bus Control Interface

This device is a read/write slave device meeting all Philips I²C-bus specifications except a "general call." The bus has to be controlled by a master device that generates the serial clock SCL, controls bus access and generates the START and STOP conditions while the device works as a slave. Both master and slave can operate as a transmitter or receiver, but the master device determines which mode is activated. A device that sends data onto the bus is defined as the transmitter, and a device receiving data as the receiver.

I²C-bus logic levels noted herein are based on a percentage of the power supply (V_{DD}). A logic-one corresponds to a nominal voltage of V_{DD} , while a logic-zero corresponds to ground (V_{SS}).

5.1 Bus Conditions

Data transfer on the bus can only be initiated when the bus is not busy. During the data transfer, the data line (SDA) must remain stable whenever the clock line (SCL) is high. Changes in the data line while the clock line is high will be interpreted by the device as a START or STOP condition. The following bus conditions are defined by the I²C-bus protocol.

5.1.1. Not Busy

Both the data (SDA) and clock (SCL) lines remain high to indicate the bus is not busy.

5.1.2. START Data Transfer

A high to low transition of the SDA line while the SCL input is high indicates a START condition. All commands to the device must be preceded by a START condition.

5.1.3. STOP Data Transfer

A low to high transition of the SDA line while SCL is held high indicates a STOP condition. All commands to the device must be followed by a STOP condition.

5.1.4. Data Valid

The state of the SDA line represents valid data if the SDA line is stable for the duration of the high period of the SCL line after a START condition occurs. The data on the SDA line must be changed only during the low period of the SCL signal. There is one clock pulse per data bit.

Each data transfer is initiated by a START condition and terminated with a STOP condition. The number of data bytes transferred between START and STOP conditions is determined by the master device, and can continue indefinitely. However, data that is overwritten to the device after the first sixteen bytes will overflow into the first register, then the second, and so on, in a first-in, first-overwritten fashion.

FS6377

5.1.5. Acknowledge

When addressed, the receiving device is required to generate an acknowledge after each byte is received. The master device must generate an extra clock pulse to coincide with the acknowledge bit. The acknowledging device must pull the SDA line low during the high period of the master acknowledge clock pulse. Setup and hold times must be taken into account.

The master must signal an end of data to the slave by not generating an acknowledge bit on the last byte that has been read (clocked) out of the slave. In this case, the slave must leave the SDA line high to enable the master to generate a STOP condition.

5.2 I²C-bus Operation

All programmable registers can be accessed randomly or sequentially via this bi-directional two wire digital interface. The device accepts the following I²C-bus commands.

5.2.1. Slave Address

After generating a START condition, the bus master broadcasts a seven-bit slave address followed by a R/W bit. The address of the device is:

A6	A5	A4	A3	A2	A1	A0
1	0	1	1	X	0	0

where X is controlled by the logic level at the ADDR pin.

The variable ADDR bit allows two different devices to exist on the same bus. Note that every device on an I²C-bus must have a unique address to avoid bus conflicts. The default address sets A2 to one via the pull-up on the ADDR pin.

5.2.2. Random Register Write Procedure

Random write operations allow the master to directly write to any register. To initiate a write procedure, the R/W bit that is transmitted after the seven-bit device address is a logic-low. This indicates to the addressed slave device that a register address will follow after the slave device acknowledges its device address. The register address is written into the slave's address pointer. Following an acknowledge by the slave, the master is allowed to write eight bits of data into the addressed register. A final acknowledge is returned by the device, and the master generates a STOP condition.

If either a STOP or a repeated START condition occurs during a register write, the data that has been transferred is ignored.

5.2.3. Random Register Read Procedure

Random read operations allow the master to directly read from any register. To perform a read procedure, the R/W bit that is transmitted after the seven-bit address is a logic-low, as in the register write procedure. This indicates to the addressed slave device that a register address will follow after the slave device acknowledges its device address. The register address is then written into the slave's address pointer.

Following an acknowledge by the slave, the master generates a repeated START condition. The repeated START terminates the write procedure, but not until after the slave's address pointer is set. The slave address is then resent, with the R/W bit set this time to a logic-high, indicating to the slave that data will be read. The slave will acknowledge the device address, and then transmits the eight-bit word. The master does not acknowledge the transfer but does generate a STOP condition.

5.2.4. Sequential Register Write Procedure

Sequential write operations allow the master to write to each register in order. The register pointer is automatically incremented after each write. This procedure is more efficient than the random register write if several registers must be written.

To initiate a write procedure, the R/W bit that is transmitted after the seven-bit device address is a logic-low. This indicates to the addressed slave device that a register address will follow after the slave device acknowledges its device address. The register address

FS6377

is written into the slave's address pointer. Following an acknowledge by the slave, the master is allowed to write up to sixteen bytes of data into the addressed register before the register address pointer overflows back to the beginning address. An acknowledge by the device between each byte of data must occur before the next data byte is sent.

Registers are updated every time the device sends an acknowledge to the host. The register update does not wait for the STOP condition to occur. Registers are therefore updated at different times during a sequential register write.

5.2.5. Sequential Register Read Procedure

Sequential read operations allow the master to read from each register in order. The register pointer is automatically incremented by one after each read. This procedure is more efficient than the random register read if several registers must be read.

To perform a read procedure, the R/W bit that is transmitted after the seven-bit address is a logic-low, as in the register write procedure. This indicates to the addressed slave device that a register address will follow after the slave device acknowledges its device address. The register address is then written into the slave's address pointer.

Following an acknowledge by the slave, the master generates a repeated START condition. The repeated START terminates the write procedure, but not until after the slave's address pointer is set. The slave address is then resent, with the R/W bit set this time to a logic-high, indicating to the slave that data will be read. The slave will acknowledge the device address, and then transmits all 16 bytes of data starting with the initial addressed register. The register address pointer will overflow if the initial register address is larger than zero. After the last byte of data, the master does not acknowledge the transfer but does generate a STOP condition.

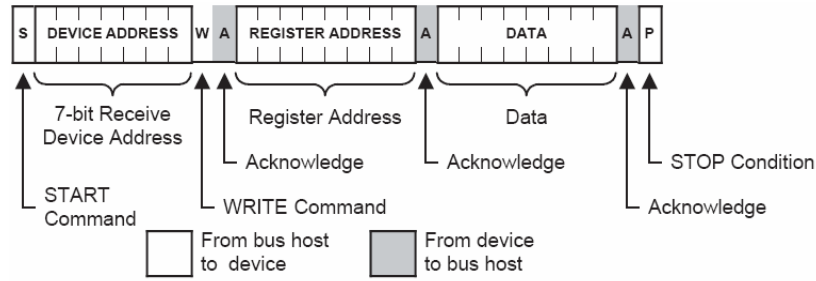

Figure 5: Random Register Write Procedure

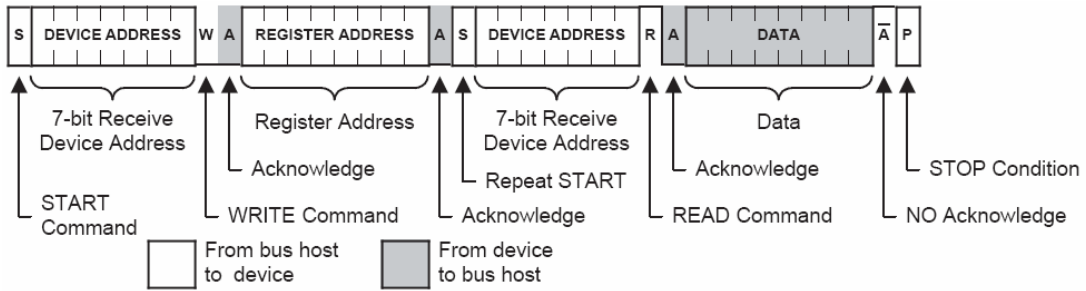

Figure 6: Random Register Read Procedure

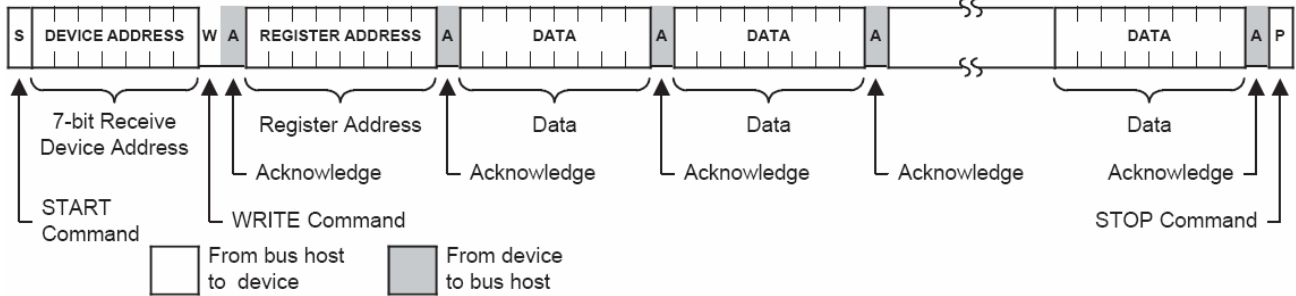

Figure 7: Sequential Register Write Procedure

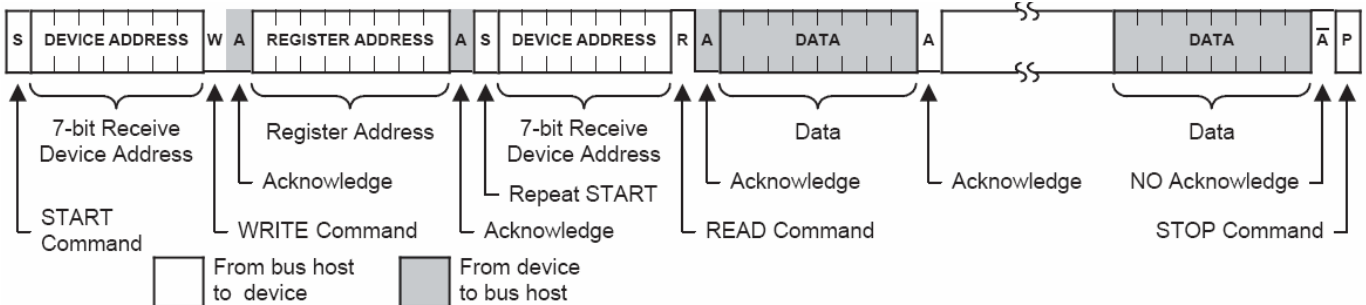

Figure 8: Sequential Register Read Procedure

6.0 Programming Information

Table 3: Register Map

Address	BIT 7	BIT 6	BIT 5	BIT 4	BIT 3	BIT 2	BIT 1	BIT 0
Byte 15	MUX_D2[1:0] (selected via SEL_CD = 1)		MUX_C2[1:0] (selected via SEL_CD = 1)		PDPOST_D	PDPOST_C	PDPOST_B	PDPOST_A
Byte 14	POST_D2[3:0] (selected via SEL_CD = 1)				POST_C2[3:0] (selected via SEL_CD = 1)			
Byte 13	POST_D1[3:0] (selected via SEL_CD = 0)				POST_C1[3:0] (selected via SEL_CD = 0)			
Byte 12	POST_B[3:0]				POST_A[3:0]			
Byte 11	MUX_D1[1:0] (selected via SEL_CD = 0)		Reserved (0)	LFTC_C2 (SEL_CD = 1)	CP_C2 (SEL_CD = 1)	FBKDIV_D2[10:8] <i>M-Counter</i> (selected via SEL_CD pin = 1)		
Byte 10	FBKDIV_C2[7:3] <i>M-Counter</i> (selected via SEL_CD pin = 1)					FBKDIV_C2[2:0] <i>A-Counter</i> (selected via SEL_CD pin = 1)		
Byte 9	REFDIV_C2[7:0] (selected via SEL_CD pin = 1)							
Byte 8	MUX_C1[1:0] (selected via SEL_CD = 0)		PDPLL_C	LFTC_C1 (SEL_CD = 0)	CP_C1 (SEL_CD = 0)	FBKDIV_c1[10:8] <i>M-Counter</i> (selected via SEL_CD = 0)		
Byte 7	FBKDIV_C1[7:3] <i>M-Counter</i> (selected via SEL_CD = 0)					FBKDIV_C1[2:0] <i>A-Counter</i> (selected via SEL_CD = 1)		
Byte 6	REFDIV_C1[7:0] (selected via SEL_CD = 0)							
Byte 5	MUX_B[1:0]		PDPLL_B	LFTC_B	CP_B	FBKDIV_B[10:8] <i>M-Counter</i>		
Byte 4	FBKDIV_B[7:3] <i>M-Counter</i>					FBKDIV_B[2:0] <i>A-Counter</i>		
Byte 3	REFDIV_B[7:0]							
Byte 2	MUX_A[1:0]		PDPLL_A	LFTC_A	CP_A	FBKDIV_A[10:8] <i>M-Counter</i>		
Byte 1	FBKDIV_A[7:3] <i>M-Counter</i>					FBKDIV_A[2:0] <i>A-Counter</i>		
Byte 0	REFDIV_A[7:0]							

Note: All register bits are cleared to zero on power-up.

6.1 Control Bit Assignment

If any PLL control bit is altered during device operation, including those bits controlling the reference and feedback dividers, the output frequency will slew smoothly (in a glitch-free manner) to the new frequency. The slew rate is related to the programmed loop filter time constant.

However, any programming changes to any mux or post divider control bits will cause a glitch on an operating clock output.

FS6377

6.2 Power-Down

All power-down functions are controlled by enable bits. The bits select which portions of the device to power-down when the PD input is asserted.

Table 4: Power-Down Bits

Name	Description	
Power-Down PLL A		
PDPLL_A (Bit 21)	Bit = 0	Power on
	Bit = 1	Power off
Power-Down PLL B		
PDLL_B (Bit 45)	Bit = 0	Power on
	Bit = 1	Power off
Power-Down PLL C		
PDLL_C (Bit 69)	Bit = 0	Power on
	Bit = 1	Power off
Reserved (0) (Bit 69)	Set these reserved bits to zero (0)	
Power-Down POST Divider A		
PDPOSTA (Bit 120)	Bit = 0	Power on
	Bit = 1	Power off
Power-Down POST Divider B		
PDPOSTB (Bit 121)	Bit = 0	Power on
	Bit = 1	Power off
Power-Down POST Divider C		
PDPOSTC (Bit 122)	Bit = 0	Power on
	Bit = 1	Power off
Power-Down POST Divider D		
PDPOSTD (Bit 123)	Bit = 0	Power on
	Bit = 1	Power off

Table 5: Divider Control Bits

Name	Description	
REFDIV_A[7:0] (Bits 7-0)	Reference Divider A (N_R)	
REFDIV_B[7:0] (Bits 31-24)	Reference Divider B (N_R)	
REFDIV_C1[7:0] (Bits 55-48)	Reference Divider C1 (N_R) <i>selected when the SEL_CD pin = 0</i>	
REFDIV_C2[7:0] (Bits 79-72)	Reference Divider C2 (N_R) <i>selected when the SEL_CD pin = 1</i>	
Feedback Divider A (N_F)		
FBKDIV_A[10:0] (Bits 18-8)	FBKDIV_A[2:0]	A-Counter value
	FBKDIV_A[10:3]	M-Counter value
Feedback Divider B (N_F)		
FBKDIV_B[10:0] (Bits 42-32)	FBKDIV_B[2:0]	A-Counter value
	FBKDIV_B[10:3]	M-Counter value
Feedback Divider C1 (N_F) <i>selected when the SEL_CD pin = 0</i>		
FBKDIV_C1[10:0] (Bits 66-56)	FBKDIV_C1[2:0]	A-Counter value
	FBKDIV_C1[10:3]	M-Counter value
Feedback Divider C2 (N_F) <i>selected when the SEL_CD pin = 1</i>		
FBKDIV_C2[10:0] (Bits 90-80)	FBKDIV_C2[2:0]	A-Counter value
	FBKDIV_C2[10:3]	M-Counter value

FS6377

Table 6: Divider Control Bits

Name	Description
POST_A[3:0] (Bits 99-96)	POST divider A (see Table 7)
POST_B[3:0] (Bits 103-100)	POST divider B (see Table 7)
POST_C1[3:0] (Bits 107-104)	POST divider C1 (see Table 7) <i>selected when the SEL_CD pin = 0</i>
POST_C2[3:0] (Bits 115-112)	POST divider C2 (see Table 7) <i>selected when the SEL_CD pin = 1</i>
POST_D1[3:0] (Bits 111-108)	POST divider D1 (see Table 7) <i>selected when the SEL_CD pin = 0</i>
POST_D2[3:0] (Bits 119-116)	POST divider D2 (see Table 7) <i>selected when the SEL_CD pin = 1</i>

Table 7: Post Divider Modulus

BIT [3]	BIT [2]	BIT [1]	BIT [0]	Divide By
0	0	0	0	1
0	0	0	1	2
0	0	1	0	3
0	0	1	1	4
0	1	0	0	5
0	1	0	1	6
0	1	1	0	8
0	1	1	1	9
1	0	0	0	10
1	0	0	1	12
1	0	1	0	15
1	0	1	1	16
1	1	0	0	18
1	1	0	1	20
1	1	1	0	25
1	1	1	1	50

FS6377

Table 8: PLL Tuning Bits

Name	Description	
Loop Filter Time Constant A		
LFTC_A (Bit 20)	Bit = 0	Short time constant: 7 μ s
	Bit = 1	Long time constant: 20 μ s
Loop Filter Time Constant B <i>selected when the SEL_CD pin = 0</i>		
LFTC_B (Bit 44)	Bit = 0	Short time constant: 7 μ s
	Bit = 1	Long time constant: 20 μ s
Loop Filter Time Constant C1 <i>selected when the SEL_CD pin = 1</i>		
LFTC_C1 (Bit 68)	Bit = 0	Short time constant: 7 μ s
	Bit = 1	Long time constant: 20 μ s
Loop Filter Time Constant C2		
LFTC_C2 (Bit 92)	Bit = 0	Short time constant: 7 μ s
	Bit = 1	Long time constant: 20 μ s
Charge Pump A		
CP_A (Bit 19)	Bit = 0	Current = 2 μ A
	Bit = 1	Current = 10 μ A
Charge Pump B		
CP_B (Bit 43)	Bit = 0	Current = 2 μ A
	Bit = 1	Current = 10 μ A
Charge Pump C1 <i>selected when the SEL_CD pin = 0</i>		
CP_C1 (Bit 67)	Bit = 0	Current = 2 μ A
	Bit = 1	Current = 10 μ A
Charge Pump C2 <i>selected when the SEL_CD pin = 1</i>		
CP_C2 (Bit 91)	Bit = 0	Current = 2 μ A
	Bit = 1	Current = 10 μ A

FS6377

Table 9: Mux Select Bits

Name	Description		
Mux A Frequency Select			
MUX_A[1:0] (Bits 23-22)	Bit 23	Bit 22	
	0	0	Reference frequency
	0	1	PLL A frequency
	1	0	PLL B frequency
	1	1	PLL C frequency
Mux B Frequency Select			
MUX_B[1:0] (Bits 47-46)	Bit 47	Bit 46	
	0	0	Reference frequency
	0	1	PLL A frequency
	1	0	PLL B frequency
	1	1	PLL C frequency
Mux C1 Frequency Select <i>selected when the SEL_CD pin = 0</i>			
MUX_C1[1:0] (Bits 71-70)	Bit 71	Bit 70	
	0	0	Reference frequency
	0	1	PLL A frequency
	1	0	PLL B frequency
	1	1	PLL C frequency
Mux C2 Frequency Select <i>selected when the SEL_CD pin = 1</i>			
MUX_C2[1:0] (Bits 125-124)	Bit 125	Bit 124	
	0	0	Reference frequency
	0	1	PLL A frequency
	1	0	PLL B frequency
	1	1	PLL C frequency
Mux D1 Frequency Select <i>selected when the SEL_CD pin = 0</i>			
MUX_D1[1:0] (Bits 95-94)	Bit 95	Bit 94	
	0	0	Reference frequency
	0	1	PLL A frequency
	1	0	PLL B frequency
	1	1	PLL C frequency
Mux D2 Frequency Select <i>selected when the SEL_CD pin = 1</i>			
MUX_D2[1:0] (Bits 127-126)	Bit 127	Bit 126	
	0	0	Reference frequency
	0	1	PLL A frequency
	1	0	PLL B frequency
	1	1	PLL C frequency

7.0 Electrical Specifications

Table 10: Absolute Maximum Ratings

Parameter	Symbol	Min.	Max.	Units
Supply voltage, dc ($V_{SS} = \text{ground}$)	V_{DD}	$V_{SS} - 0.5$	7	V
Input voltage, dc	V_I	$V_{SS} - 0.5$	$V_{DD} + 0.5$	V
Output voltage, dc	V_O	$V_{SS} - 0.5$	$V_{DD} + 0.5$	V
Input clamp current, dc ($V_I < 0$ or $V_I > V_{DD}$)	I_{IK}	-50	50	mA
Output clamp current, dc ($V_I < 0$ or $V_I > V_{DD}$)	I_{OK}	-50	50	mA
Storage temperature range (non-condensing)	T_S	-65	150	°C
Ambient temperature range, under bias	T_A	-55	125	°C
Junction temperature	T_J		150	°C
Re-flow solder profile				Per IPC/JEDEC J-STD-020B
Input static discharge voltage protection (MIL-STD 883E, Method 3015.7)			2	kV

Stresses above those listed under Absolute Maximum Ratings may cause permanent damage to the device. These conditions represent a stress rating only, and functional operation of the device of these or any other conditions above the operational limits noted in this specification is not implied. Exposure to maximum rating conditions for extended conditions may affect device performance, functionality and reliability.

CAUTION: ELETROSTATIC SENSITIVE DEVICE

Permanent damage resulting in a loss of functionality or performance may occur if this device is subjected to a high-energy electrostatic discharge.

Table 11: Operating Conditions

Parameter	Symbol	Conditions/Descriptions	Min.	Typ.	Max.	Units
Supply voltage	V_{DD}	$5V \pm 10\%$ $3.3V \pm 10\%$	4.5 3	5 3.3	5.5 3.6	V
Ambient operating temperature range	T_A	Commercial Industrial	0 -40		70 85	°C
Crystal resonator frequency	f_{XIN}		5		27	MHz
Crystal resonator load capacitance	C_{XL}	Parallel resonant, AT cut		18		pF
Serial data transfer rate		Standard mode	10		100	kb/s
Output driver load capacitance	C_L				15	pF

Table 12: DC Electrical Specifications

Parameter	Symbol	Conditions/Descriptions	Min.	Typ.	Max.	Units
Overall						
Supply current, dynamic, with load outputs	I_{DD}	$V_{DD} = 5.5V$, $f_{CLK} = 50MHz$, $C_L = 15pF$ See Figure 10 for more information			43	mA
Supply current, static	I_{DDL}	$V_{DD} = 5.5V$, device powered down			0.3	mA
Power-Down, Output Enable Pins (PD, OE)						
High-level input voltage	V_{IH}	$V_{DD} = 5.5V$ $V_{DD} = 3.6V$		3.85 2.52	$V_{DD} + 0.3$ $V_{DD} + 0.3$	V
Low-level input voltage	V_{IL}	$V_{DD} = 5.5V$ $V_{DD} = 3.6V$		$V_{SS} - 0.3$ $V_{SS} - 0.3$	1.65 1.08	V
Hysteresis voltage	V_{hys}	$V_{DD} = 5.5V$ $V_{DD} = 3.6V$			2.20 1.44	V
High-level input current	I_{IH}		-1		1	μA
Low-level input current (pull-up)	I_{IL}	$V_{IL} = 0V$	-20	-36	-80	μA
Serial Interface I/O (SCL, SDA)						
High-level input voltage	V_{IH}	$V_{DD} = 5.5V$ $V_{DD} = 3.6V$		3.85 2.52	$V_{DD} + 0.3$ $V_{DD} + 0.3$	V
Low-level input voltage	V_{IL}	$V_{DD} = 5.5V$ $V_{DD} = 3.6V$		$V_{SS} - 0.3$ $V_{SS} - 0.3$	1.65 1.08	V
Hysteresis voltage	V_{hys}	$V_{DD} = 5.5V$ $V_{DD} = 3.6V$			2.20 1.44	V
High-level input current	I_{IH}		-1		1	μA
Low-level input current (pull-up)	I_{IL}	$V_{IL} = 0V$	-20	-36	-80	μA
Low-level output sink current (SDA)	I_{OL}	$V_{OL} = 0.4V$, $V_{DD} = 5.5V$			26	mA

FS6377

Table 12: DC Electrical Specifications (continued)

Mode and Frequency Select Inputs (ADDR, SEL_CD)						
High-level input voltage	V_{IH}	$V_{DD} = 5.5V$ $V_{DD} = 3.6V$	2.4 2.0		$V_{DD} + 0.3$ $V_{DD} + 0.3$	V
Low-level input voltage	V_{IL}	$V_{DD} = 5.5V$ $V_{DD} = 3.6V$	$V_{SS} - 0.3$ $V_{SS} - 0.3$		0.8 0.8	V
High-level input current	I_{IH}		-1		1	μA
Low-level input current (pull-up)	I_{IL}		-20	-36	-80	μA
Crystal Oscillator Feedback (XIN)						
Threshold bias voltage	V_{TH}	$V_{DD} = 5.5V$ $V_{DD} = 3.6V$			2.9 1.7	V
High-level input current	I_{IH}	$V_{DD} = 5.5V$ $V_{DD} = 5.5V$, oscillator powered down			54 15	μA mA
Low-level input current	I_{IL}	$V_{DD} = 5.5V$	-25	-54	-75	μA
Crystal loading capacitance*	$C_{L(xtal)}$	As seen by an external crystal connected to XIN and XOUT			18	pF
Input loading capacitance*	$C_{L(XIN)}$	As seen by an external clock driver on XOUT; XIN unconnected			36	pF
Crystal Oscillator Driver (XOUT)						
High-level output source current	I_{OH}	$V_{DD} = V_{(XIN)} = 5.5V$, $V_O = 0V$	10	21	30	mA
Low-level output sink current	I_{OL}	$V_{DD} = 5.5V$, $V_{(XIN)} = 0V$, $V_O = 5.5V$	-10	-21	-30	mA
Clock Outputs (CLK_A, CLK_B, CLK_C, CLK_D)						
High-level output source current	I_{OH}	$V_O = 2.4V$			-125	mA
Low-level output sink current	I_{OL}	$V_O = 0.4V$			23	mA
Output impedance	Z_{OH} Z_{OL}	$V_O = 0.5V_{DD}$; output driving high $V_O = 0.5V_{DD}$; output driving low			29 27	Ω
Tristate output current	I_Z		-10		10	μA
Short circuit source current*	I_{SCH}	$V_{DD} = 5.5V$, $V_O = 0V$; shorted for 30s, max.			-150	mA
Short circuit sink current*	I_{SCL}	$V_{DD} = V_O = 5.5V$; shorted for 30s, max.			123	mA

Unless otherwise stated, $V_{DD} = 5.0V \pm 10\%$, no load on any output, and ambient temperature range $T_A = 0^\circ C$ to $70^\circ C$. Parameters denoted with an asterisk (*) represent nominal characterization data and are not currently production tested on any specific limits. Min. and max. characterization data are $\pm 3\sigma$ from typical. Negative currents indicate current flows out of the device.

Voltage (V)	Low Drive Current (mA)			High Drive Current (mA)			
	Min.	Typ.	Max.	Voltage (V)	Min.	Typ.	Max.
0	0	0	0	0	-87	-112	-150
0.2	9	11	12	0.5	-85	-110	-147
0.5	22	25	29	1	-83	-108	-144
0.7	29	34	40	1.5	-80	-104	-139
1	39	46	55	2	-74	-97	-131
1.2	44	52	64	2.5	-65	-88	-121
1.5	51	61	76	2.7	-61	-84	-116
1.7	55	66	83	3	-53	-77	-108
2	60	73	92	3.2	-48	-71	-102
2.2	62	77	97	3.5	-39	-62	-92
2.5	65	81	104	3.7	-32	-55	-85
2.7	65	83	108	4	-21	-44	-74
3	66	85	112	4.2	-13	-36	-65
3.5	67	87	117	4.5	0	-24	-52
4	68	88	119	4.7		-15	-43
4.5	69	89	120	5		0	-28
5		91	121	5.2			-11
5.5			123	5.5			0

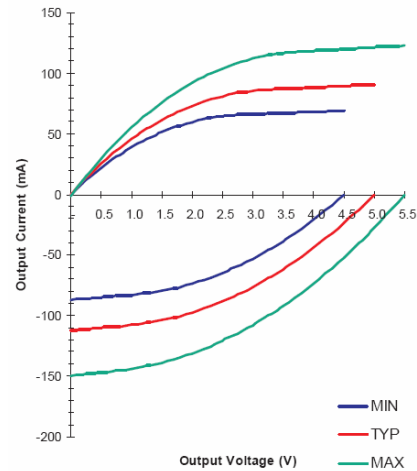

The data in this table represents nominal characterization data only.

Figure 9: CLK_A, CLK_B, CLK_C, CLK_D Clock Outputs

FS6377

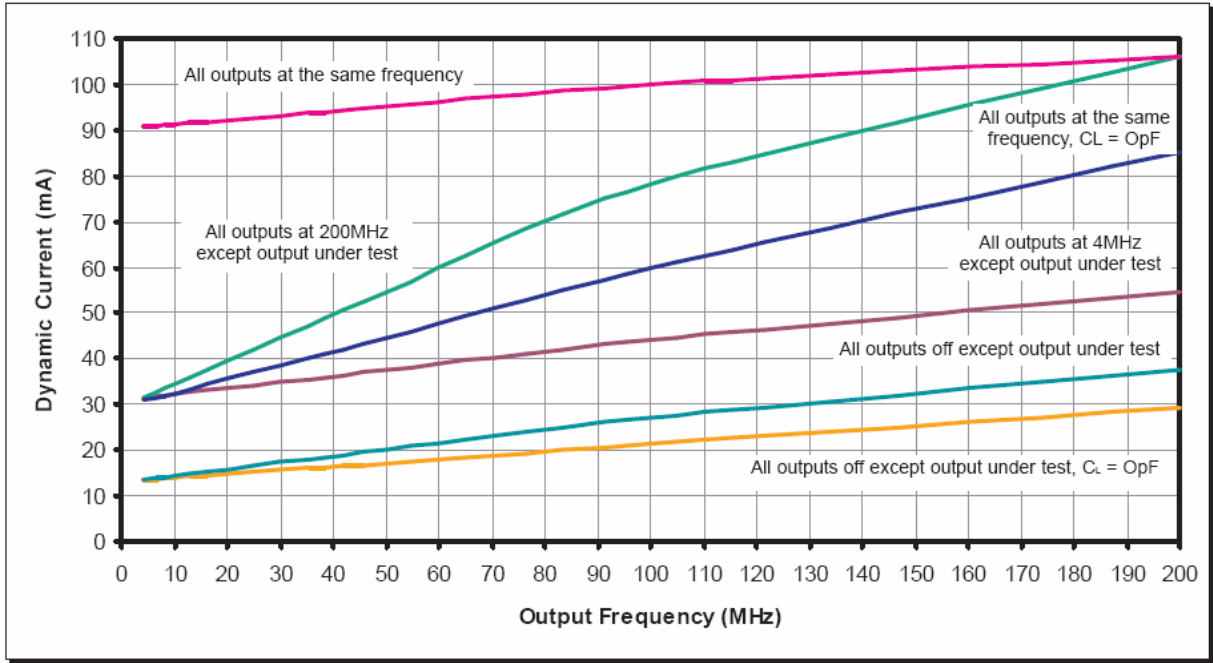

$V_{DD} = 5.0V$; Reference Frequency = 27.00MHz; VCO Frequency = 200MHz, $C_L = 17pF$ except where noted

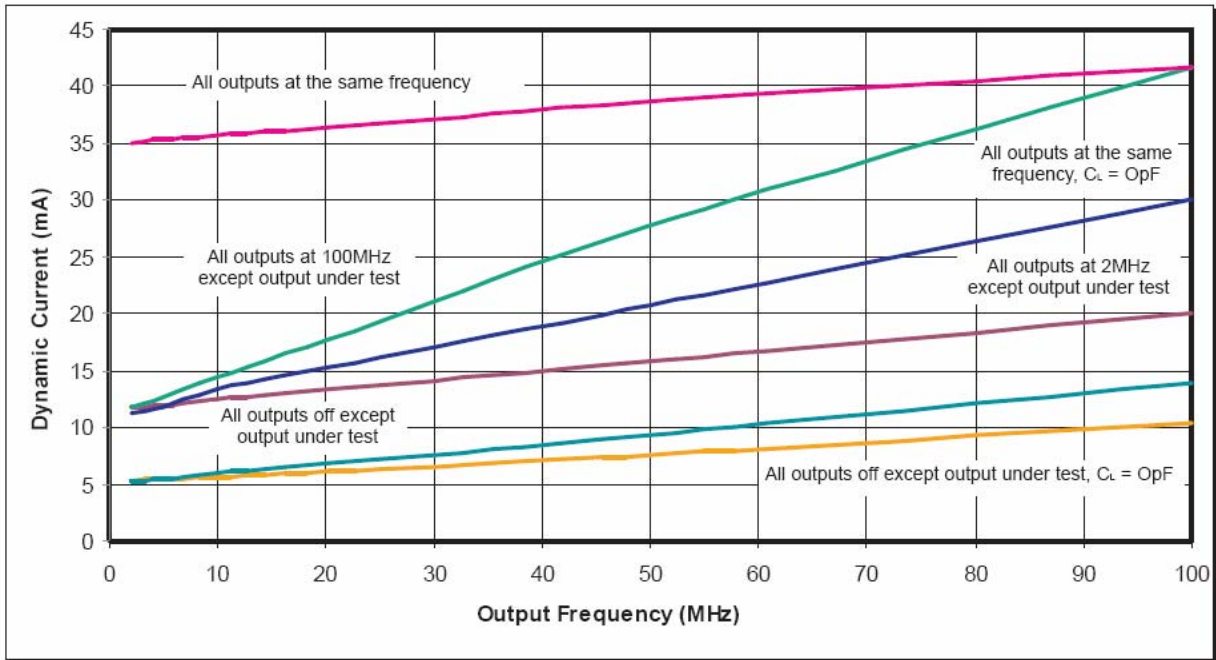

$V_{DD} = 3.3V$; Reference Frequency = 27.00MHz; VCO Frequency = 100MHz, $C_L = 17pF$ except where noted

Figure 10: Dynamic Current vs. Output Frequency

FS6377

Table 13: AC Timing Specifications

Parameter	Symbol	Conditions/Descriptions	Clock (MHz)	Min.	Typ.	Max.	Units
Overall							
Output frequency*	f_o	$V_{DD} = 5.5V$ $V_{DD} = 3.6V$		0.8 0.8		150 100	MHz
VCO frequency*	f_{VCO}	$V_{DD} = 5.5V$ $V_{DD} = 3.6V$		40 40		230 170	MHz
VCO gain*	A_{VCO}				400		MHz/V
Loop filter time constant*		LFTC bit = 0 LFTC bit = 1			7 20		μs
Rise time*	t_r	$V_O = 0.5V$ to $4.5V$; $C_L = 15pF$ $V_O = 0.3V$ to $3.0V$; $C_L = 15pF$			1.9 1.6		ns
Fall time*	t_f	$V_O = 4.5V$ to $0.5V$; $C_L = 15pF$ $V_O = 3.0V$ to $0.3V$; $C_L = 15pF$			1.8 1.5		ns
Tristate enable delay*	t_{PZL}, t_{PZH}			1		8	ns
Tristate disable delay*	t_{PZL}, t_{PZH}			1		8	ns
Clock stabilization time*	t_{STB}	Output active from power-up, via PD pin After last register is written			100	1	μs ms
Divider Modulus							
Feedback divider	N_F	See Table 2		8		2047	
Reference divider	N_R			1		255	
Post divider	N_P	See Table 8		1		50	
Clock Outputs (PLL A clock via CLK_A pin) Approximate							
Duty cycle*		Ratio of pulse width (as measured from rising edge to next falling edge at 2.5V) to one clock period	100	45		55	%
Jitter, long term ($\sigma y(\tau)$)*	$t_{j(LT)}$	On rising edges 500 μs apart at 2.5V relative to an ideal clock, $C_L = 15pF$, $f_{XIN} = 14.318MHz$, $N_F = 220$, $N_R = 63$, $N_{PX} = 50$, no other PLLs active	100		45		ps
		On rising edges 500 μs apart at 2.5V relative to an ideal clock, $C_L = 15pF$, $f_{XIN} = 14.318MHz$, $N_F = 220$, $N_R = 63$, $N_{PX} = 50$, all other PLLs active (B = 60MHz, C = 40MHz, D = 14.318MHz)	50		165		
Jitter, period (peak-peak)*	$t_{j(AP)}$	From rising edge to the next rising edge at 2.5V, $C_L = 15pF$, $f_{XIN} = 14.318MHz$, $N_F = 220$, $N_R = 63$, $N_{PX} = 50$, no other PLLs active	100		110		ps
		From rising edge to the next rising edge at 2.5V, $C_L = 15pF$, $f_{XIN} = 14.318MHz$, $N_F = 220$, $N_R = 63$, $N_{PX} = 50$, all other PLLs active (B = 60MHz, C = 40MHz, D = 14.318MHz)	50		390		
Clock Outputs (PLL B clock via CLK_B pin) Approximate							
Duty cycle*		Ratio of pulse width (as measured from rising edge to next falling edge at 2.5V) to one clock period	100	45		55	%
Jitter, long term ($\sigma y(\tau)$)*	$t_{j(LT)}$	On rising edges 500 μs apart at 2.5V relative to an ideal clock, $C_L = 15pF$, $f_{XIN} = 14.318MHz$, $N_F = 220$, $N_R = 63$, $N_{PX} = 50$, no other PLLs active	100		45		ps
		On rising edges 500 μs apart at 2.5V relative to an ideal clock, $C_L = 15pF$, $f_{XIN} = 14.318MHz$, $N_F = 220$, $N_R = 63$, $N_{PX} = 50$, all other PLLs active (A = 50MHz, C = 40MHz, D = 14.318MHz)	60		75		
Jitter, period (peak-peak)*	$t_{j(AP)}$	From rising edge to the next rising edge at 2.5V, $C_L = 15pF$, $f_{XIN} = 14.318MHz$, $N_F = 220$, $N_R = 63$, $N_{PX} = 50$, no other PLLs active	100		120		ps
		From rising edge to the next rising edge at 2.5V, $C_L = 15pF$, $f_{XIN} = 14.318MHz$, $N_F = 220$, $N_R = 63$, $N_{PX} = 50$, all other PLLs active (A = 50MHz, C = 40MHz, D = 14.318MHz)	60		400		

FS6377

Table 13: AC Timing Specifications continued

Clock Outputs (PLL_C clock via CLK_C pin) Approximate						
Duty cycle*		Ratio of pulse width (as measured from rising edge to next falling edge at 2.5V) to one clock period	100	45	55	%
Jitter, long term ($\sigma_y(\tau)$)*	$t_{j(LT)}$	On rising edges 500 μ s apart at 2.5V relative to an ideal clock, $C_L = 15$ pF, $f_{XIN} = 14.318$ MHz, $N_F = 220$, $N_R = 63$, $N_{PX} = 50$, no other PLLs active	100	45		ps
		On rising edges 500 μ s apart at 2.5V relative to an ideal clock, $C_L = 15$ pF, $f_{XIN} = 14.318$ MHz, $N_F = 220$, $N_R = 63$, $N_{PX} = 50$, all other PLLs active (A = 50MHz, B = 60MHz, D = 14.318MHz)	40	105		
Jitter, period (peak-peak)*	$t_{j(\Delta P)}$	From rising edge to the next rising edge at 2.5V, $C_L = 15$ pF, $f_{XIN} = 14.318$ MHz, $N_F = 220$, $N_R = 63$, $N_{PX} = 50$, no other PLLs active	100	120		ps
		From rising edge to the next rising edge at 2.5V, $C_L = 15$ pF, $f_{XIN} = 14.318$ MHz, $N_F = 220$, $N_R = 63$, $N_{PX} = 50$, all other PLLs active (A = 50MHz, B = 60MHz, D = 14.318MHz)	40	440		
Clock Outputs (Crystal Oscillator via CLK_D pin) Approximate						
Duty cycle*		Ratio of pulse width (as measured from rising edge to next falling edge at 2.5V) to one clock period	14.318	45	55	%
Jitter, long term ($\sigma_y(\tau)$)*	$t_{j(LT)}$	On rising edges 500 μ s apart at 2.5V relative to an ideal clock, $C_L = 15$ pF, $f_{XIN} = 14.318$ MHz, no other PLLs active	14.318	20		ps
		From rising edges to the next at 2.5V, $C_L = 15$ pF, $f_{XIN} = 14.318$ MHz, all other PLLs active (A = 50MHz, B = 60MHz, C = 40MHz)	14.318	40		
Jitter, period (peak-peak)*	$t_{j(\Delta P)}$	From rising edge to the next rising edge at 2.5V, $C_L = 15$ pF, $f_{XIN} = 14.318$ MHz, no other PLLs active	14.318	90		ps
		From rising edge to the next rising edge at 2.5V, $C_L = 15$ pF, $f_{XIN} = 14.318$ MHz, all other PLLs active (A = 50MHz, B = 60MHz, C = 40MHz)	14.318	450		

Unless otherwise stated, $V_{DD} = 5.0V \pm 10\%$, no load on any output, and ambient temperature range $T_A = 0^\circ C$ to $70^\circ C$. Parameters denoted with an asterisk (*) represent nominal characterization data and are not currently production tested to any specific limits. Min. and max. characterization data are $\pm 3\sigma$ from typical.

Table 14: Serial Interface Timing Specifications

Parameter	Symbol	Conditions/Description	Standard Mode		Units
			Min.	Max.	
Clock frequency	f_{SCL}	SCL	0	100	kHz
Bus free time between STOP and START	t_{BUF}		4.7		μ s
Set-up time, START (repeated)	$t_{su:STA}$		4.7		μ s
Hold time, START	$t_{hd:STA}$		4.0		μ s
Set-up time, data input	$t_{su:DAT}$	SDA	250		ns
Hold time, data input	$t_{hd:DAT}$	SDA	0		μ s
Output data valid from clock	t_{AA}	Minimum delay to bridge undefined region of the falling edge of SCL to avoid unintended START or STOP		3.5	μ s
Rise time, data and clock	t_R	SDA, SCL		1000	ns
Fall time, data and clock	t_F	SDA, SCL		300	ns
High time, clock	t_{HI}	SCL	4.0		μ s
Low time, clock	t_{LO}	SCL	4.7		μ s
Set-up time, STOP	$T_{su:STO}$		4.0		μ s

Unless otherwise stated, all power supplies = $3.3V \pm 5\%$, no load on any output, and ambient temperature range $T_A = 0^\circ C$ to $70^\circ C$. Parameters denoted with an asterisk (*) represent nominal characterization data and are not currently production tested to any specific limits. Min. and max. characterization data are $\pm 3\sigma$ from typical.

FS6377

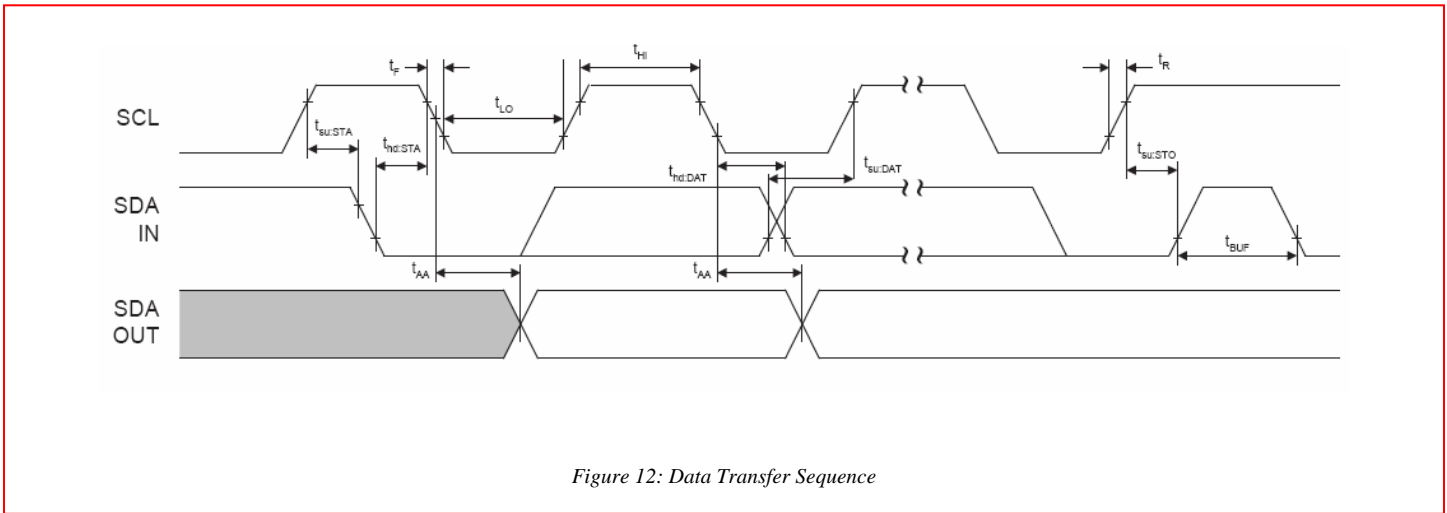
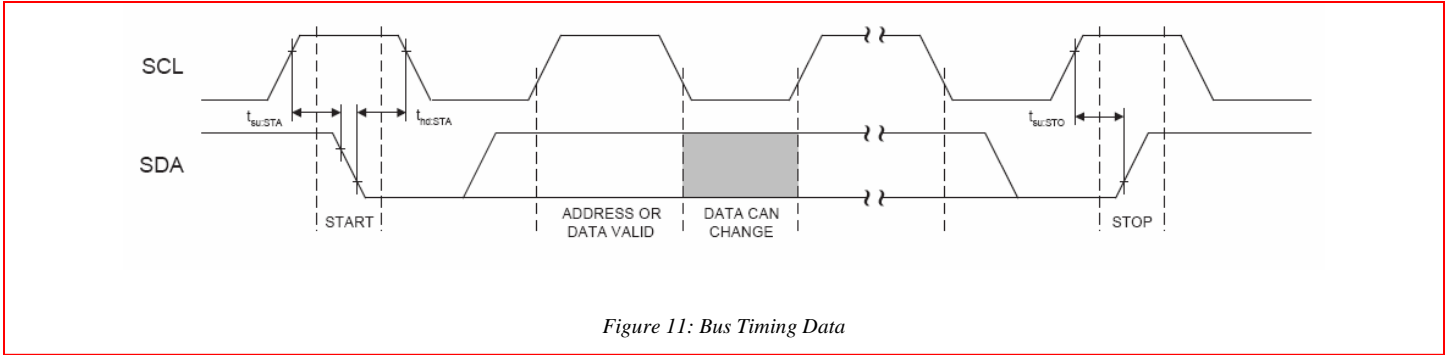

8.0 Package Information – For Both ‘Green’ and ‘No-Green’

Table 15: 16-pin SOIC (0.150") Package Dimensions

Dimensions	Inches		Millimeters	
	Min.	Max.	Min.	Max.
A	0.061	0.068	1.55	1.73
A1	0.004	0.0098	0.102	0.249
A2	0.055	0.061	1.40	1.55
B	0.013	0.019	0.33	0.49
C	0.0075	0.0098	0.191	0.249
D	0.386	0.393	9.80	9.98
E	0.150	0.157	3.81	3.99
e	0.050 BSC		1.27 BSC	
H	0.230	0.244	5.84	6.20
h	0.010	0.016	0.25	0.41
L	0.016	0.035	0.41	0.89
⊖	0°	8°	0°	8°

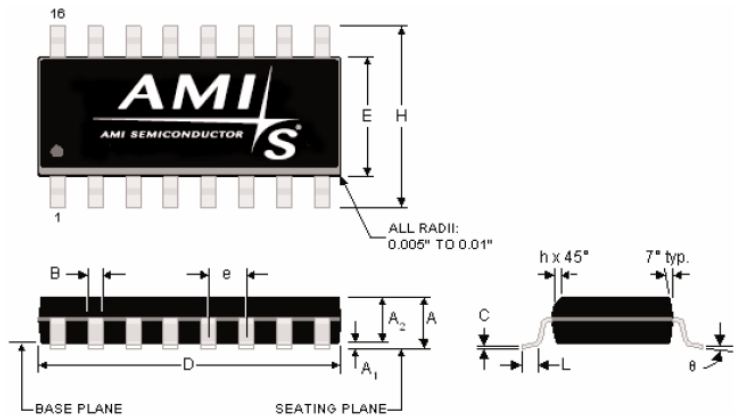

FS6377

Table 16: 16-pin SOIC (0.150") Package Characteristics

Parameter	Symbol	Conditions/Description	Typ.	Units
Thermal impedance, junction to free-air 16-pin 0.150" SOIC	Θ_{JA}	Air flow = 0m/s	110	°C/W
Lead inductance, self	L ₁₁	Corner lead	4.0	nH
		Center lead	3.0	nH
Lead inductance, mutual	L ₁₂	Any lead to any adjacent lead	0.4	nH
Lead capacitance, bulk	C ₁₁	Any lead to V _{SS}	0.5	pF

9.0 Ordering Information

Part Number	Package	Shipping Configuration	Temperature Range
FS6377-01G-XTD	16-pin (0.150") SOIC (small outline package) 'Green' or lead-free packaging	Tube/Tray	0°C to 70°C (commercial)
FS6377-01G-XTP	16-pin (0.150") SOIC (small outline package) 'Green' or lead-free packaging	Tape & Reel	0°C to 70°C (commercial)
FS6377-01iG-XTD	16-pin (0.150") SOIC (small outline package) 'Green' or lead-free packaging	Tube/Tray	-40°C to 85°C (industrial)
FS6377-01iG-XTP	16-pin (0.150") SOIC (small outline package) 'Green' or lead-free packaging	Tape & Reel	-40°C to 85°C (industrial)

10.0 Demonstration Software

Windows XP- (and earlier) based software is available from ON Semiconductor that illustrates the capabilities of the FS6377 and aids in application development.

Contact your local sales representative for more information.

10.1 Software Requirements

- PC running MS Windows 95/98, 98 SE, ME, NT4, 2000, XP Home Edition, or XP Professional Edition
- 1.8MB available space on hard drive C
- Internet access to operate program found at www.amis.com/products/clocks/FS6377.html

10.2 Demo Program Operation

Launch the demo program from the website. Note that the parallel port cannot be accessed if your machine is not connected to the demo board. A warning message will appear as shown in Figure 13.

Clicking "Ignore" starts the program for calculation only.

The FS6377 demo hardware is available on a limited basis for demonstration by an ON SEMICONDUCTOR field applications engineer, but is no longer available for purchase.

The opening screen is shown in Figure 14.

FS6377

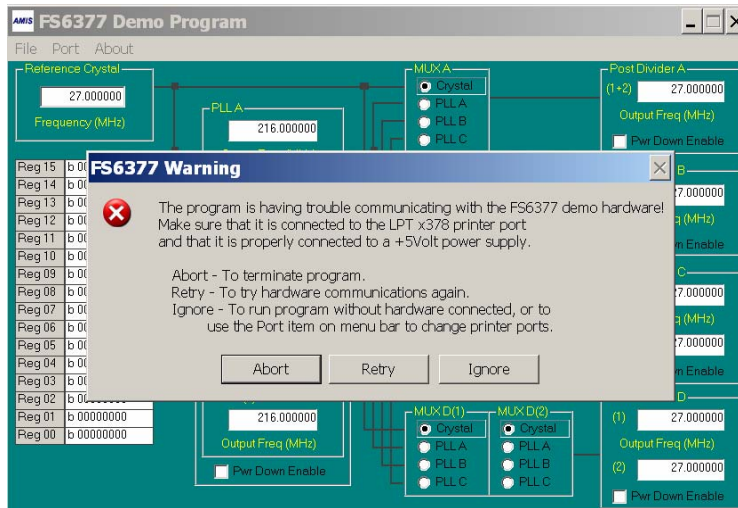

Figure 13: Warning Message- Click "Ignore"

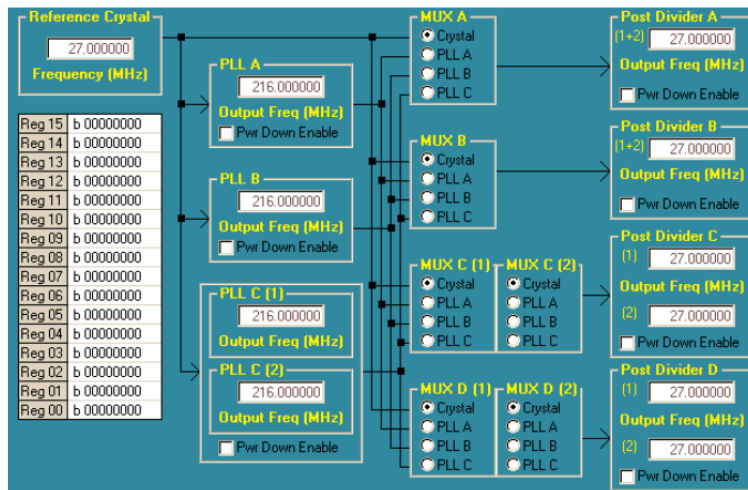

Figure 14: Opening Screen

10.2.1. Example Programming

Type a value for the crystal resonator frequency in MHz in the reference crystal box. This frequency provides the basis for all of the PLL calculations that follow.

Next, click on the PLL A box. A pop-up screen similar to Figure 15 should appear. Type in a desired output clock frequency in MHz, set the operating voltage (3.3V or 5V) and the desired maximum output frequency error. Pressing Calculate Solutions generates several possible divider and VCO-speed combinations.

FS6377

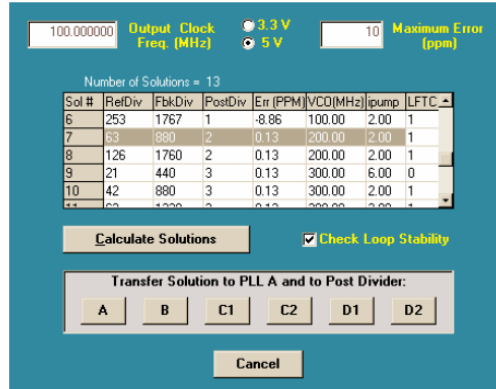

Figure 15: PLL Screen

For a 100MHz output, the VCO should ideally operate at a higher frequency, and the reference and feedback dividers should be as small as possible. In this example, highlight Solution #7. Notice the VCO operates at 200MHz with a post divider of two to obtain an optimal 50 percent duty cycle.

Now choose which mux and post divider to use (that is, choose an output pin for the 100MHz output). Selecting A places the PostDiv value in Solution #7 into post divider A and switches mux A to take the output of PLL A.

The PLL screen should disappear, and now the value in the PLL A box is the new VCO frequency chosen in Solution #7. Also note that mux A has been switched to PLL A and the post divider A has the chosen 100MHz output displayed.

Repeat the steps for PLL B.

PLL C supports two different output frequencies depending on the setting of the SEL_CD pin. Both mux C and mux D are also affected by the logic level on the SEL_CD pin, as are the post dividers C and D.

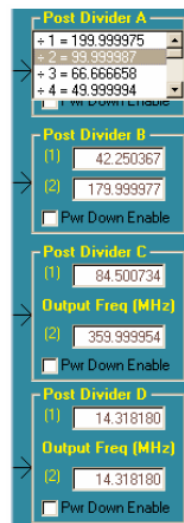

Figure 16: Post Divider Menu

FS6377

Click on PLL C1 to open the PLL screen. Set a desired frequency, however, now choose the post divider B as the output divider. Notice the post divider box has split in two (as shown in Figure 16). The post divider B box now shows that the divider is dependent on the setting of the SEL_CD pin for as long as mux B is the PLL C output.

Clicking on post divider A reveals a pull-down menu provided to permit adjustment of the post divider value independently of the PLL screen. A typical menu is shown in Figure 16. The range of possible post divider values is also given in Table 7.

The register settings are shown to the left in the screen shown in Figure 14. Clicking on a register location displays a screen shown in Figure 17. Individual bits can be poked, or the entire register value can be changed.

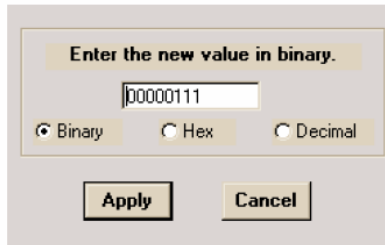



Figure 17: Register Screen

11.0 Revision History

Revision	Date	Modification
1	2004	Initial doc
2	2004	
3	October 2007	Update content to new AMIS template
4	May 2008	Update to ON Semiconductor template

ON Semiconductor and  are registered trademarks of Semiconductor Components Industries, LLC (SCILLC). SCILLC reserves the right to make changes without further notice to any products herein. SCILLC makes no warranty, representation or guarantee regarding the suitability of its products for any particular purpose, nor does SCILLC assume any liability arising out of the application or use of any product or circuit, and specifically disclaims any and all liability, including without limitation special, consequential or incidental damages. "Typical" parameters which may be provided in SCILLC data sheets and/or specifications can and do vary in different applications and actual performance may vary over time. All operating parameters, including "Typicals" must be validated for each customer application by customer's technical experts. SCILLC does not convey any license under its patent rights nor the rights of others. SCILLC products are not designed, intended, or authorized for use as components in systems intended for surgical implant into the body, or other applications intended to support or sustain life, or for any other application in which the failure of the SCILLC product could create a situation where personal injury or death may occur. Should Buyer purchase or use SCILLC products for any such unintended or unauthorized application, Buyer shall indemnify and hold SCILLC and its officers, employees, subsidiaries, affiliates, and distributors harmless against all claims, costs, damages, and expenses, and reasonable attorney fees arising out of, directly or indirectly, any claim of personal injury or death associated with such unintended or unauthorized use, even if such claim alleges that SCILLC was negligent regarding the design or manufacture of the part. SCILLC is an Equal Opportunity/Affirmative Action Employer. This literature is subject to all applicable copyright laws and is not for resale in any manner.

PUBLICATION ORDERING INFORMATION

LITERATURE FULFILLMENT:

Literature Distribution Center for ON Semiconductor
P.O. Box 5163, Denver, Colorado 80217 USA
Phone: 303-675-2175 or 800-344-3860 Toll Free USA/Canada
Fax: 303-675-2176 or 800-344-3867 Toll Free USA/Canada
Email: orderlit@onsemi.com

N. American Technical Support: 800-282-9855
Toll Free USA/Canada
Europe, Middle East and Africa Technical Support:
Phone: 421 33 790 2910
Japan Customer Focus Center
Phone: 81-3-5773-3850

ON Semiconductor Website: www.onsemi.com

Order Literature: <http://www.onsemi.com/orderlit>

For additional information, please contact your local Sales Representative