

Feature

- The chips are electrically insulated from bottom plate, 2500V AC voltage.
- Complete pressure connection structure, with excellent temperature Characteristics and power cycling capacity.
- Forced air cooling for modules below 400A and air cooling or water, Cooling for modules above 500A.

Typical application

- DC power supplies of appliances and devices.
- AC and DC motor control, Soft starting for motors.
- Various rectifying power supply.
- Electric welders, Frequency transformers, Battery charging and discharging

$I_{F(AV)}$	25A
V_{RRM}	500~2500V
I_{FSM}	0.65 kA
I^2t	2.1 A²S*10³



SYMBOL	CHARACTERISTIC	TEST CONDITIONS	T _j (°C)	VALUE			UNIT
				Min	Type	Max	
$I_{F(AV)}$	Mean forward current	180 half sine wave 50Hz Single side cooled, T _C =100°C	150			25	A
$I_F(RMS)$	RMS forward current		150			39	A
V_{RRM}	Repetitive peak reverse voltage	V_{RRM} tp=10ms $V_{RSM} = V_{RRM} + 100V$	150	500		2500	V
I_{RRM}	Repetitive peak current	at V_{RRM}	150			8	mA
I_{FSM}	Surge forward current	10ms half sine wave	150			0.65	KA
I^2t	I^2T for fusing coordination	$V_R = 0.6V_{RRM}$				2.1	A ² S*10 ³
V_{TO}	Threshold voltage		150			0.80	V
r_T	Forward slop resistance					6.8	mΩ
V_{FM}	Peak forward voltage	$I_{FM} = 80A$	25			1.65	V
$R_{th(j-c)}$	Thermal resistance Junction to case	At 180° sine Single side cooled				1.300	°C/W
$R_{th(c-h)}$	Thermal resistance case to heatsink	At 180° sine Single side cooled				0.2	°C/W
V_{iso}	Isolation voltage	50Hz, R.M.S, t=1min, I _{iso} : 1mA(max)		2500			V
F_m	Terminal connection torque(M5)				4		N·m
	Mounting torque(M6)				6		N·m
T_{stg}	Stored temperature			-40		125	°C
W_t	Weight				190		g
Outline	Fig.1						

Peak forward Voltage Vs. Peak forward Current

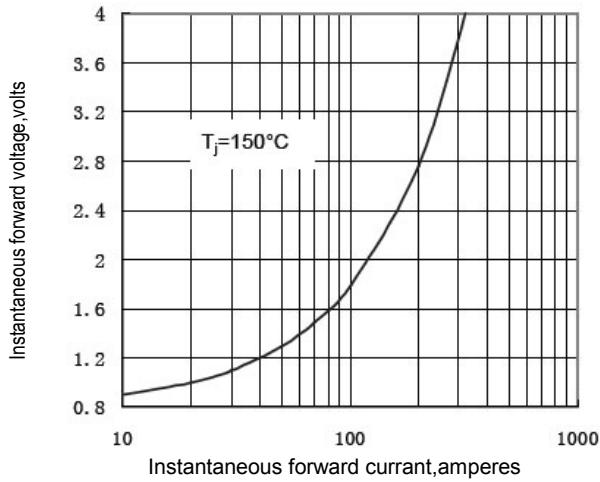

Fig.1

Max. junction To case Thermal Impedance Vs. Time

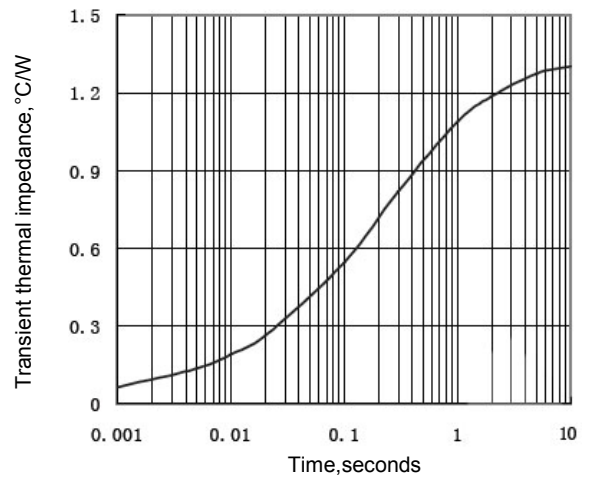

Fig.2

Max. Power Dissipation Vs. Mean forward Current

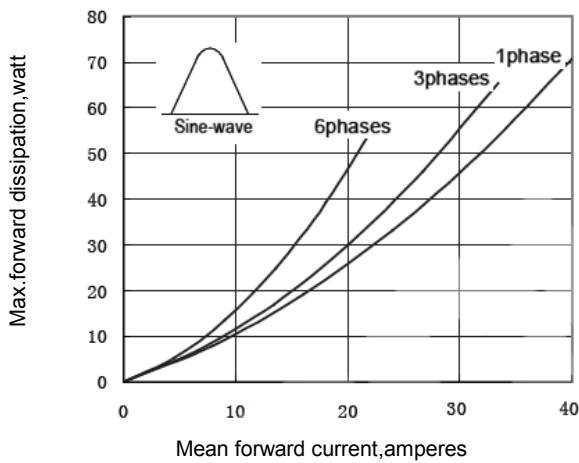

Fig.3

Max. case Temperature Vs. Mean forward Current

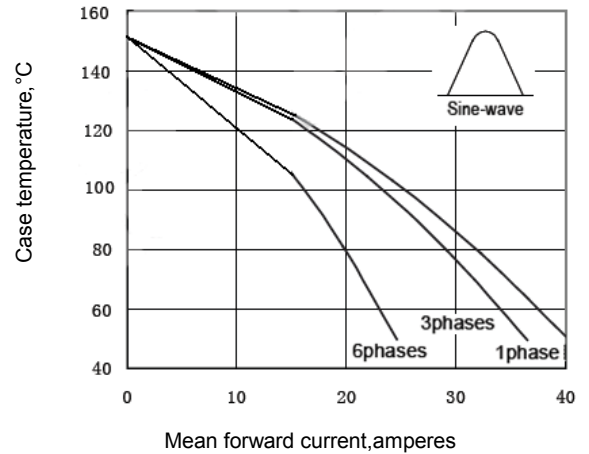

Fig.4

Max. Power Dissipation Vs. Mean forward Current

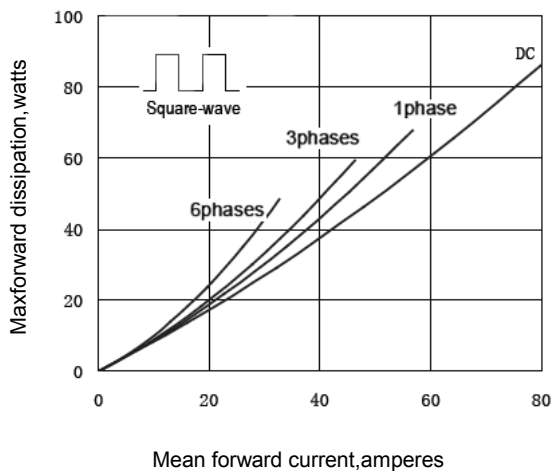

Fig.5

Max. case Temperature Vs. Mean forward Current

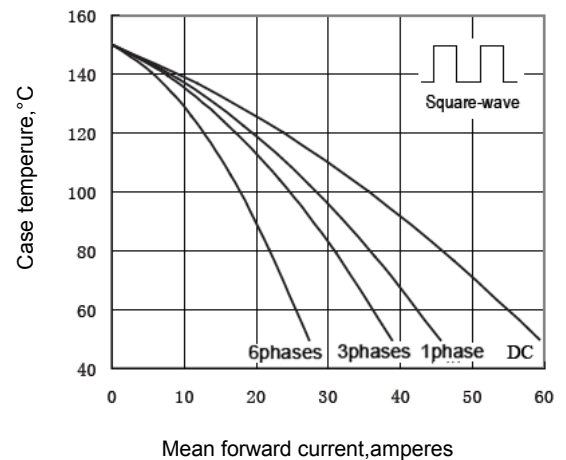

Fig.6

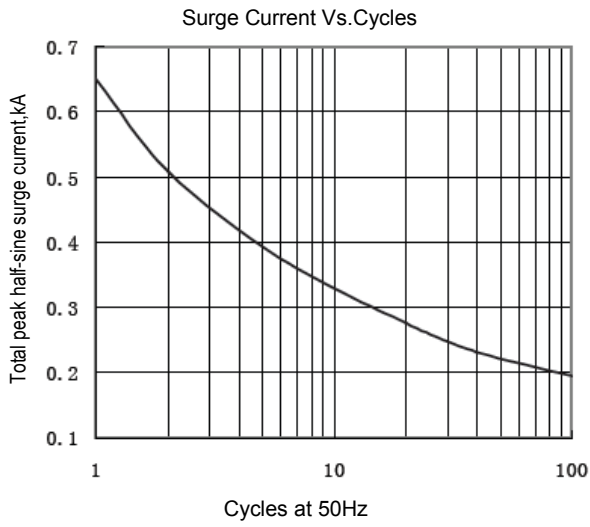

Fig.7

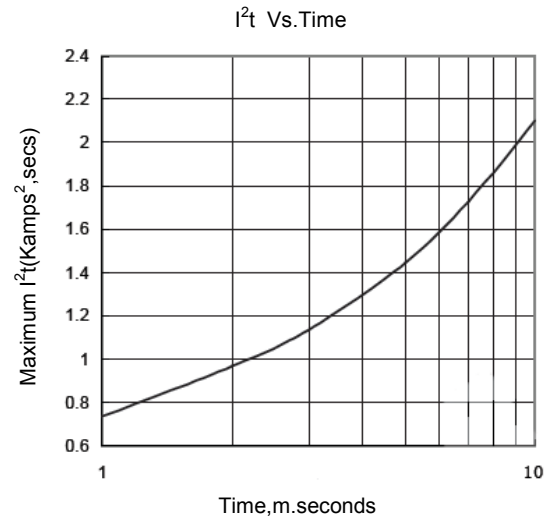

Fig.8

Outline:

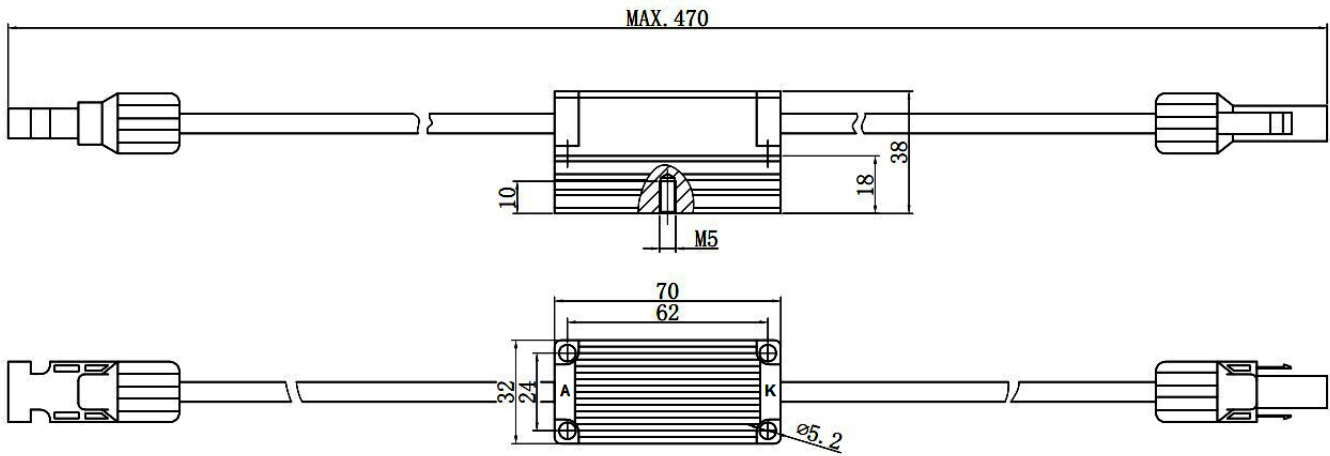

Fig 1

