

Features

- Diffused Junction
- Low Forward Voltage Drop
- High Current Capability
- High Reliability
- High Surge Current Capability

Mechanical Data

- Case: Molded Plastic
- Terminals: Plated Leads Solderable per MIL-STD-202, Method 208
- Polarity: Cathode Band
- Weight: 1.2 grams (approx.)
- Mounting Position: Any
- Marking: Type Number
- Epoxy: UL 94V-O rate flame retardant

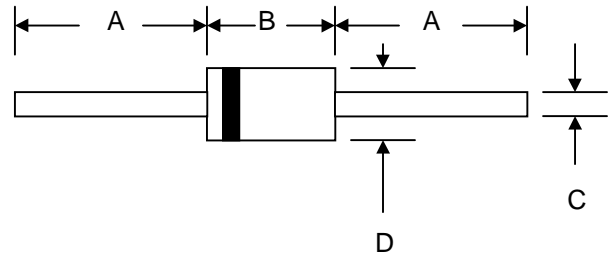

DO-201AD		
Dim	Min	Max
A	25.4	—
B	8.50	9.50
C	1.20	1.30
D	5.0	5.60
All Dimensions in mm		

Maximum Ratings and Electrical Characteristics @ $T_A=25^\circ\text{C}$ unless otherwise specified

Single Phase, half wave, 60Hz, resistive or inductive load.
For capacitive load, derate current by 20%.

Characteristic	Symbol	HER 301	HER 302	HER 303	HER 304	HER 305	HER 306	HER 307	HER 308	Unit
Peak Repetitive Reverse Voltage Working Peak Reverse Voltage DC Blocking Voltage	V_{RRM} V_{RWM} V_R	50	100	200	300	400	600	800	1000	V
RMS Reverse Voltage	$V_{R(RMS)}$	35	70	140	210	280	420	560	700	V
Average Rectified Output Current (Note 1) @ $T_A = 55^\circ\text{C}$	I_o	3.0								A
Non-Repetitive Peak Forward Surge Current 8.3ms Single half sine-wave superimposed on rated load (JEDEC Method)	I_{FSM}	150								A
Forward Voltage @ $I_F = 3.0\text{A}$	V_{FM}	1.0			1.3		1.7			V
Peak Reverse Current @ $T_A = 25^\circ\text{C}$ At Rated DC Blocking Voltage @ $T_A = 100^\circ\text{C}$	I_{RM}	10.0				100				μA
Reverse Recovery Time (Note 2)	t_{rr}	50				75				nS
Typical Junction Capacitance (Note 3)	C_j	80				50				pF
Operating Temperature Range	T_j	-65 to +125								$^\circ\text{C}$
Storage Temperature Range	T_{STG}	-65 to +150								$^\circ\text{C}$

*Glass passivated forms are available upon request

Note: 1. Leads maintained at ambient temperature at a distance of 9.5mm from the case

2. Measured with $I_F = 0.5\text{A}$, $I_R = 1.0\text{A}$, $I_{RR} = 0.25\text{A}$. See figure 5.

3. Measured at 1.0 MHz and applied reverse voltage of 4.0V D.C.

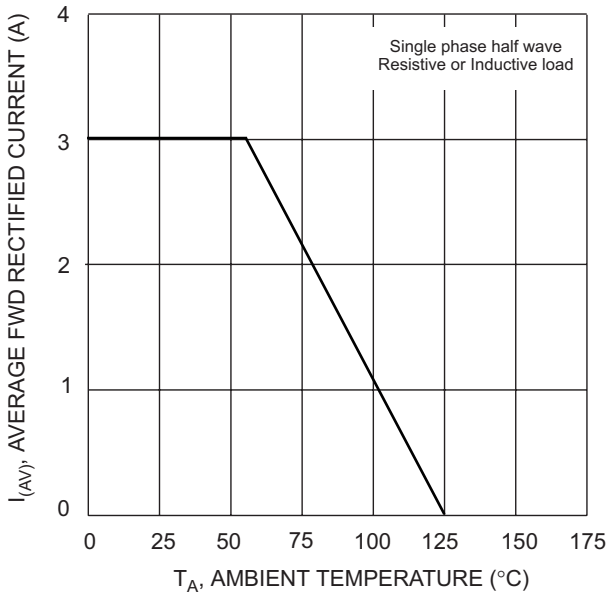

Fig. 1 Forward Current Derating Curve

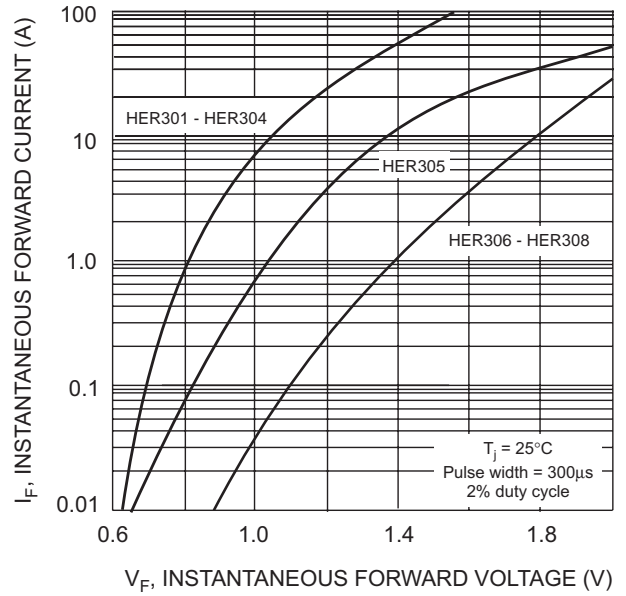

Fig. 2 Typical Forward Characteristics

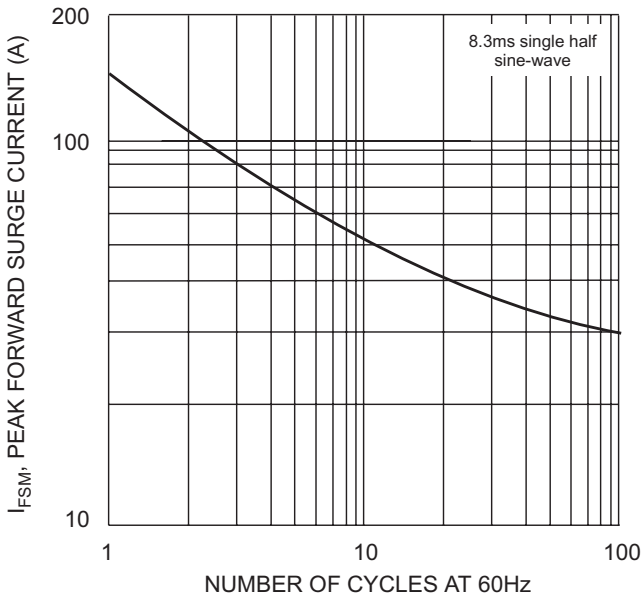

Fig. 3 Peak Forward Surge Current

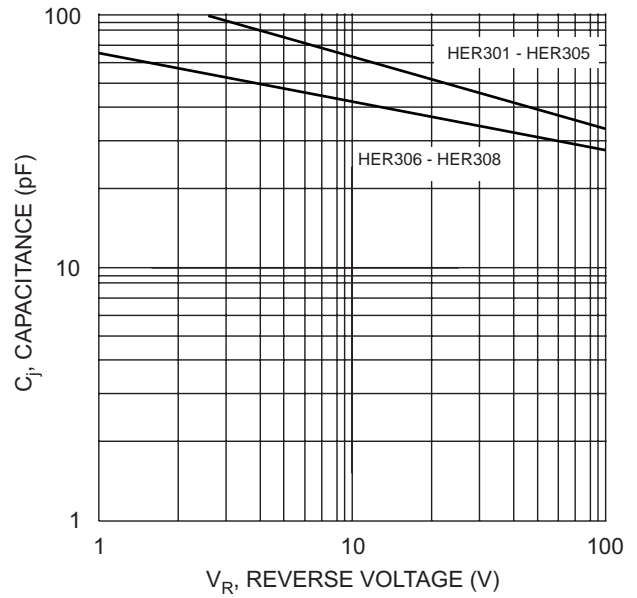
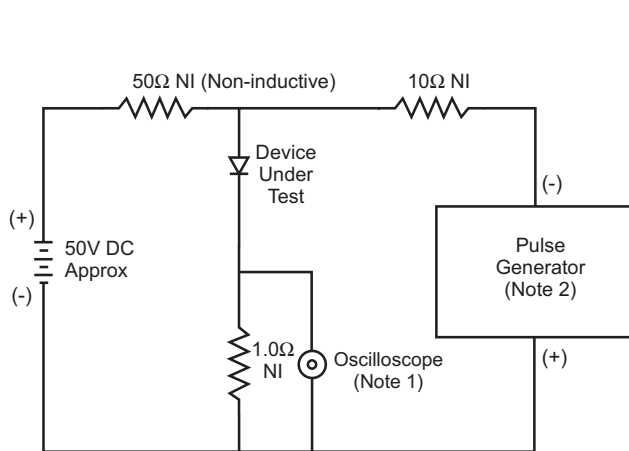
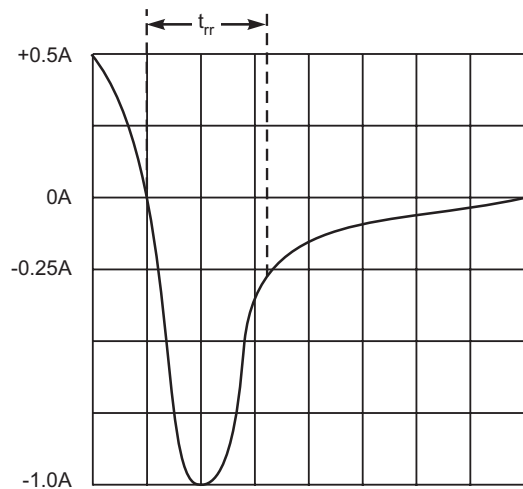

Fig. 4 Typical Junction Capacitance



- Notes:
1. Rise Time = 7.0ns max. Input Impedance = 1.0MΩ, 22pF.
 2. Rise Time = 10ns max. Input Impedance = 50Ω.



Set time base for 5/10ns/cm

Fig. 5 Reverse Recovery Time Characteristic and Test Circuit

ORDERING INFORMATION

Product No.♦	Package Type	Shipping Quantity
HER301-T3	DO-201AD	1200/Tape & Reel
HER301-TB	DO-201AD	1200/Tape & Box
HER301	DO-201AD	500 Units/Box
HER302-T3	DO-201AD	1200/Tape & Reel
HER302-TB	DO-201AD	1200/Tape & Box
HER302	DO-201AD	500 Units/Box
HER303-T3	DO-201AD	1200/Tape & Reel
HER303-TB	DO-201AD	1200/Tape & Box
HER303	DO-201AD	500 Units/Box
HER304-T3	DO-201AD	1200/Tape & Reel
HER304-TB	DO-201AD	1200/Tape & Box
HER304	DO-201AD	500 Units/Box
HER305-T3	DO-201AD	1200/Tape & Reel
HER305-TB	DO-201AD	1200/Tape & Box
HER305	DO-201AD	500 Units/Box
HER306-T3	DO-201AD	1200/Tape & Reel
HER306-TB	DO-201AD	1200/Tape & Box
HER306	DO-201AD	500 Units/Box
HER307-T3	DO-201AD	1200/Tape & Reel
HER307-TB	DO-201AD	1200/Tape & Box
HER307	DO-201AD	500 Units/Box
HER308-T3	DO-201AD	1200/Tape & Reel
HER308-TB	DO-201AD	1200/Tape & Box
HER308	DO-201AD	500 Units/Box

Products listed in **bold** are WTE **Preferred** devices.

♦T3 suffix refers to a 13" reel. TB suffix refers to Ammo Pack.

Shipping quantity given is for minimum packing quantity only. For minimum order quantity, please consult the Sales Department.

Won-Top Electronics Co., Ltd (WTE) has checked all information carefully and believes it to be correct and accurate. However, WTE cannot assume any responsibility for inaccuracies. Furthermore, this information does not give the purchaser of semiconductor devices any license under patent rights to manufacturer. WTE reserves the right to change any or all information herein without further notice.

WARNING: DO NOT USE IN LIFE SUPPORT EQUIPMENT. WTE power semiconductor products are not authorized for use as critical components in life support devices or systems without the express written approval.

Won-Top Electronics Co., Ltd.

No. 44 Yu Kang North 3rd Road, Chine Chen Dist., Kaohsiung, Taiwan

Phone: 886-7-822-5408 or 886-7-822-5410

Fax: 886-7-822-5417

Email: sales@wontop.com

Internet: http://www.wontop.com

We power your everyday.