

## 1 WATT UNREGULATED DC/DC CONVERTER

### HL01U

#### FEATURES

- LOW COST
- INTERNAL FILTERING
- SURFACE MOUNT CONSTRUCTION
- TEMPERATURE RANGE: -25°C TO +70°C
- HIGH EFFICIENCY
- NON-CONDUCTIVE CASE
- SURFACE MOUNT PACKAGE (SMD)

#### DESCRIPTION

The HL01U Series offers an extensive selection of input and output voltages to choose from. These miniature, unregulated DC/DC converters come in 24-pin DIP and SMD packages. This small size is possible through the use of surface mount manufacturing technologies.

The HL01U Series utilizes a 125KHz push-pull oscillator in the input stage with internal filtering to reduce the output noise.

The use of surface mount construction and automated manufacturing processes increase consistency and reliability while reducing overall cost.

#### ABSOLUTE MAXIMUM RATINGS

Internal Power Dissipation.....	30 Sec
Short Circuit Duration.....	Momentary
Lead Temperature (soldering, 10 seconds max).....	+300°C*

\* Note: Refer to Reflow Profile for SMD Models.

#### ORDERING INFORMATION

Device Family	HL01U
HL Indicates DC/DC Converter	xx
Model Number	yyzz
Where:	
xx = Input Voltage	
y = Number of Outputs (Single "S", Dual "D")	
zz = Output Voltage	
Package Option	Y/Z
Screening Option	H
DIP Package only	

Internet: <http://www.cdpowerelectronics.com>

**Power Electronics Division, United States**  
3400 E Britannia Drive, Tucson, Arizona 85706  
Phone: 800.547.2537 Fax: 520.770.9369

**Power Electronics Division, Europe**  
C&D Technologies (Power Electronics) Ltd.  
132 Shannon Industrial Estate, Shannon, Co. Clare, Ireland  
Tel: +353.61.474.133 Fax: +353.61.474.141

# ELECTRICAL SPECIFICATIONS

Specifications typical at  $T_A = +25^\circ\text{C}$ , nominal input voltage, rated output current unless otherwise specified.

MODEL	NOMINAL INPUT VOLTAGE (VDC)	RATED OUTPUT VOLTAGE (VDC)	RATED OUTPUT CURRENT (mA)	INPUT CURRENT		EFFICIENCY (%)
				NO LOAD (mA)	RATED LOAD (mA)	
HL01U05S05	5	5	200	30	300	70
HL01U05S12	5	12	83	30	260	74
HL01U05S15	5	15	67	30	260	74
HL01U12S05	12	5	200	25	120	67
HL01U12S12	12	12	83	25	120	70
HL01U12S15	12	15	67	25	120	70
HL01U15S05	15	5	200	20	100	67
HL01U15S12	15	12	83	20	100	70
HL01U15S15	15	15	67	20	100	70
HL01U24S05	24	5	200	15	65	67
HL01U24S12	24	12	83	15	65	70
HL01U24S15	24	15	67	15	65	70
HL01U05D05	5	$\pm 5$	$\pm 100$	30	300	70
HL01U05D12	5	$\pm 12$	$\pm 41$	30	260	74
HL01U05D15	5	$\pm 15$	$\pm 33$	30	260	74
HL01U12D05	12	$\pm 5$	$\pm 100$	25	120	67
HL01U12D12	12	$\pm 12$	$\pm 41$	25	120	70
HL01U12D15	12	$\pm 15$	$\pm 33$	25	120	70
HL01U15D05	15	$\pm 5$	$\pm 100$	20	100	67
HL01U15D12	15	$\pm 12$	$\pm 41$	20	100	70
HL01U15D15	15	$\pm 15$	$\pm 33$	20	100	70
HL01U24D05	24	$\pm 5$	$\pm 100$	15	65	67
HL01U24D12	24	$\pm 12$	$\pm 41$	15	65	70
HL01U24D15	24	$\pm 15$	$\pm 33$	15	65	70

# COMMON SPECIFICATIONS

Specifications typical at  $T_A = +25^\circ\text{C}$ , nominal input voltage, rated output current unless otherwise specified.

PARAMETER	CONDITIONS	MIN	TYP	MAX	UNITS
<b>INPUT</b>					
Voltage Range		4.5	5	5.5	VDC
		10.8	12	13.2	
		13.5	15	16.5	
		22.6	24	26.4	VDC
Reflected Ripple Current			30	100	mAp-p
<b>ISOLATION</b>					
Rated Voltage		500			VDC
Test Voltage	60 Hz, 10 Seconds	500			Vpk
Resistance			1		G $\Omega$
Capacitance			25		pF
Leakage Current	$V_{ISO} = 240\text{VAC}, 60\text{Hz}$		2		$\mu\text{Arms}$
<b>OUTPUT</b>					
Rated Power			1		W
Voltage Setpoint Accuracy			$\pm 3$	$\pm 5$	%
Temperature Coefficient			$\pm 0.02$		%/ $^\circ\text{C}$
Ripple & Noise	BW = DC to 10MHz		50	100	mVp-p
	BW = 10Hz to 2MHz		10		mVrms
Line Regulation	High Line to Low Line		1	$\pm 1.5$	%/%
Load Regulation					
5 Vout Models	25% Rated Load to Rated Load		$\pm 5$	$\pm 10$	%
All Others	10% Rated Load to Rated Load		$\pm 3$	$\pm 10$	%
<b>GENERAL</b>					
Switching Frequency			125		kHz
Package Weight			12		g
MTTF per MIL-HDBK-217, Rev. F	Circuit Stress Method				
Ground Benign	$T_A = +25^\circ\text{C}$		1100		kHr
	$T_A = +70^\circ\text{C}$		550		kHr
<b>TEMPERATURE</b>					
Specification		-25		+70	$^\circ\text{C}$
Operation		-40		+85	$^\circ\text{C}$
Storage		-40		+110	$^\circ\text{C}$

# MECHANICAL Package/Pinout "Y" and "Z"

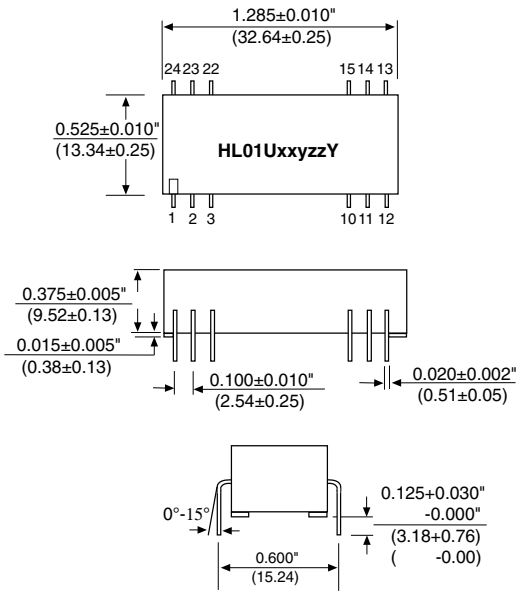

**DIP PACKAGE**

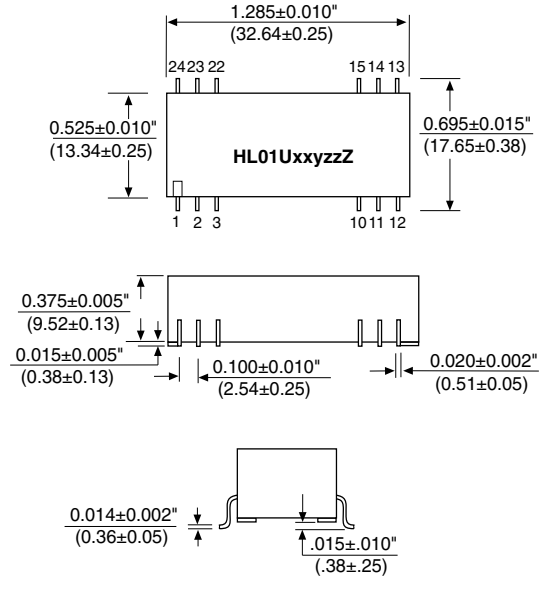

**SMD PACKAGE**

NU = Do Not Use.  
 NC = No Internal Connection.  
 Duplicate pin functions are internally connected.  
 All dimensions are in inches (millimeters).  
 GRID: 0.100 inches (2.54 millimeters)  
 Typically Marked with: specific model ordered, date code, job code and Logo.

PIN CONNECTIONS		
PIN#	SINGLES	DUALS
1	+VIN	+VIN
2	NU	-VOUT
3	NU	Common
10	-VOUT	Common
11	+VOUT	+VOUT
12	-VIN	-VIN
13	-VIN	-VIN
14	+VOUT	+VOUT
15	-VOUT	Common
22	NU	Common
23	NU	-VOUT
24	+VIN	+VIN

## RECOMMENDED LAND PATTERN

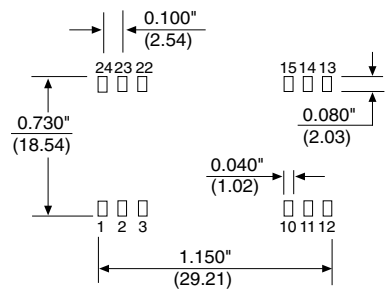

## RECOMMENDED REFLOW PROFILE

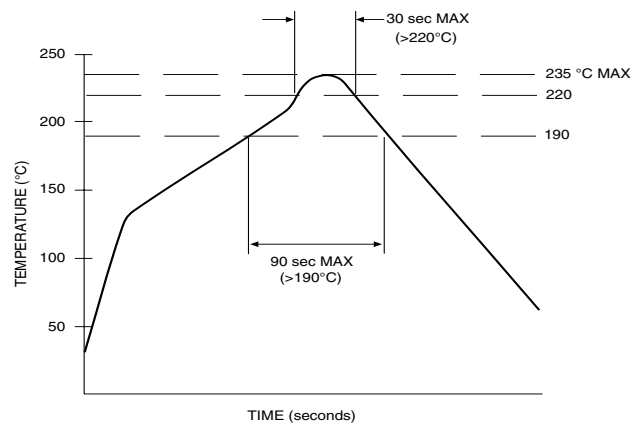

# TYPICAL PERFORMANCE CURVES

Specifications typical at  $T_A = +25^\circ\text{C}$ , nominal input voltage, rated output current unless otherwise specified.

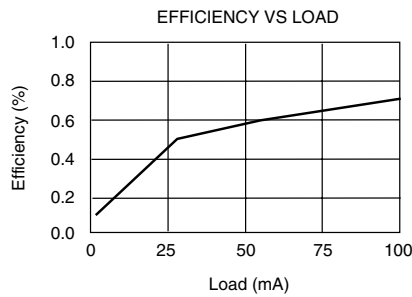
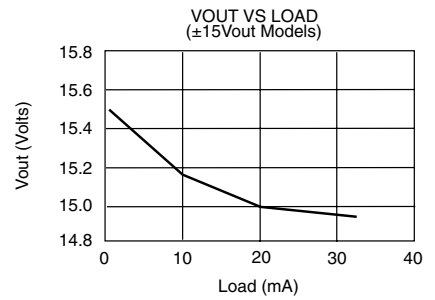
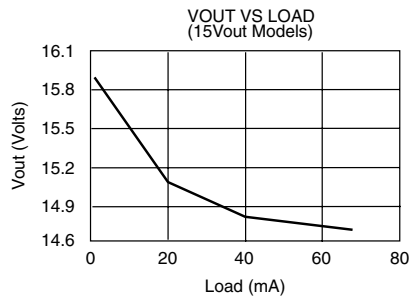
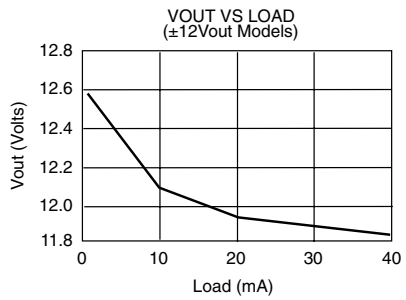
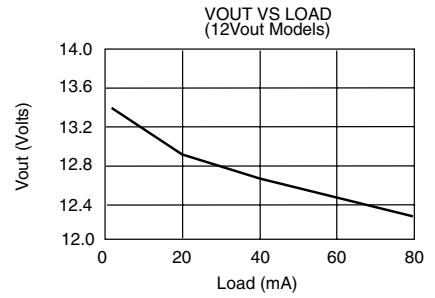
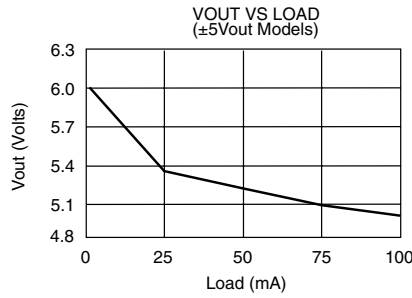
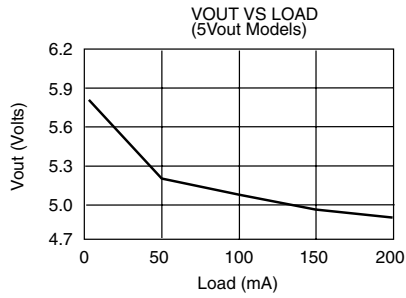

# SAFE OPERATING AREA

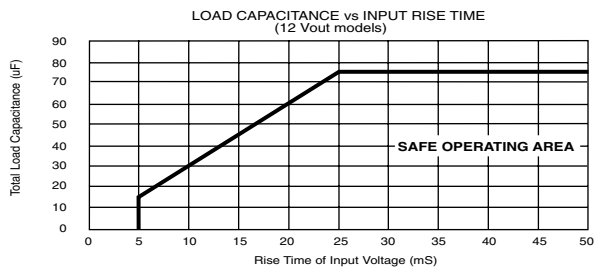
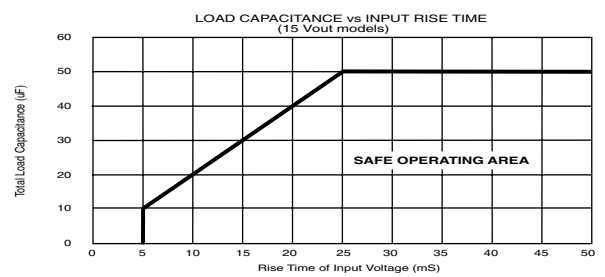
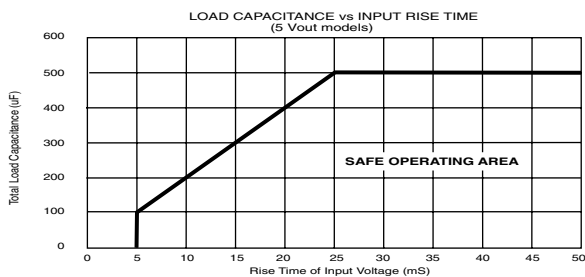

## NOTES:

- 1.) When operated within the SAFE OPERATING AREA as defined by the above curves, the output voltage of HL01U devices is guaranteed to be within 95% of its steady-state value within 100 milliseconds after the input voltage has reached 95% of its steady-state value.
- 2.) For dual output models, total load capacitance is the sum of the capacitances on the plus and minus outputs.