

# HLMP-HD55, HLMP-HM57, HLMP-HB57

## Precision Optical Performance Red, Green and Blue

### 5 mm Standard Oval LEDs



## Data Sheet



### Description

These Precision Optical Performance Oval LEDs are specifically designed for full color/video and passenger information signs. The oval shaped radiation pattern and high luminous intensity ensure these devices are excellent for wide field of view outdoor applications where a wide viewing angle and readability in sunlight are essential. These lamps have very smooth, matched radiation patterns ensuring consistent color mixing in full color applications, message uniformity across the viewing angle of the sign. High efficiency LED material is used in these lamps: higher performance Aluminum Indium Gallium Phosphide (AlInGaP II) for red color, Indium Gallium Nitride (InGaN) for blue and green. Each lamp is made with an advance optical grade epoxy offering superior high temperature and high moisture resistance in outdoor applications.

The package epoxy contains both UV-A and UV-B inhibitors to reduce the effects of long term exposure to direct sunlight.

### Features

- Well defined spatial radiation pattern
- High brightness material
- Available in red, green and blue color
  - Red AlInGaP 630 nm
  - Green InGaN 525 nm
  - Blue InGaN 470 nm
- Tinted and diffused

### Benefits

- Viewing angle designed for wide field of view applications
- Superior performance for outdoor environments

### Applications

- Full color signs
- Commercial outdoor advertising

**Caution:** InGaN devices are Class 1C HBM ESD sensitive per JEDEC standard. Please observe appropriate precautions during handling and processing. Refer to Application Note AN-1142 for additional details.

## Package Dimensions

A

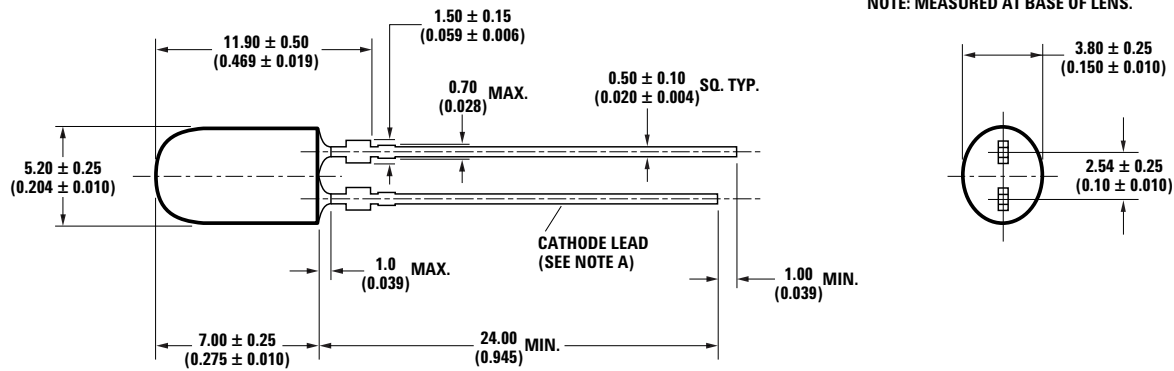

B

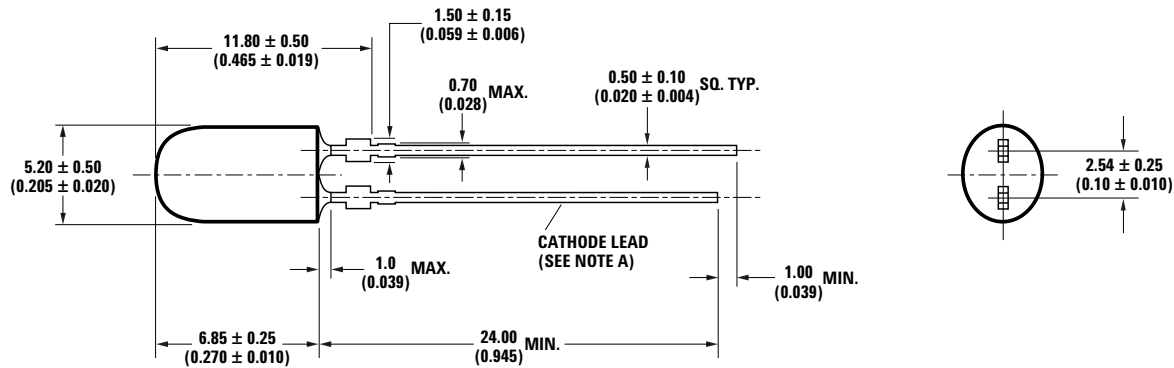

**NOTES:**

1. DIMENSIONS IN MILLIMETERS (INCHES).
2. FOR InGaN BLUE AND GREEN (PACKAGE B), IF HEAT-SINKING APPLICATION IS REQUIRED, THE TERMINAL FOR HEAT SINK IS ANODE.

## Device Selection Guide

Part Number	Color	Typical Dominant Wavelength $\lambda_d$ (nm)	Luminous Intensity $I_v$ (mcd) at 20 mA		Package Lens Type	Dimension
			Minimum	Maximum		
HLMP-HD55-NR0xx	Red	630	680	1900	Tinted, Diffused	A
HLMP-HB57-KN0xx	Blue	470	310	880	Tinted, Diffused	B
HLMP-HB57-LMCxx	Blue	470	400	680	Tinted, Diffused	B
HLMP-HB57-LP0xx	Blue	470	400	1150	Tinted, Diffused	B
HLMP-HM57-SV0xx	Green	525	1900	5500	Tinted, Diffused	B
HLMP-HM57-RSCxx	Green	525	1500	2500	Tinted, Diffused	B
HLMP-HM57-RU0xx	Green	525	1500	4200	Tinted, Diffused	B

**Notes:**

1. Tolerance for luminous intensity measurement is  $\pm 15\%$ .
2. The luminous intensity is measured on the mechanical axis of the lamp package.
3. The optical axis is closely aligned with the package mechanical axis.
4. The dominant wavelength,  $\lambda_d$ , is derived from the Chromaticity Diagram and represents the color of the lamp.
5. LED light output is bright enough to cause injuries to the eyes. Precautions must be taken to prevent looking directly at the LED with unaided eyes.

## Part Numbering System

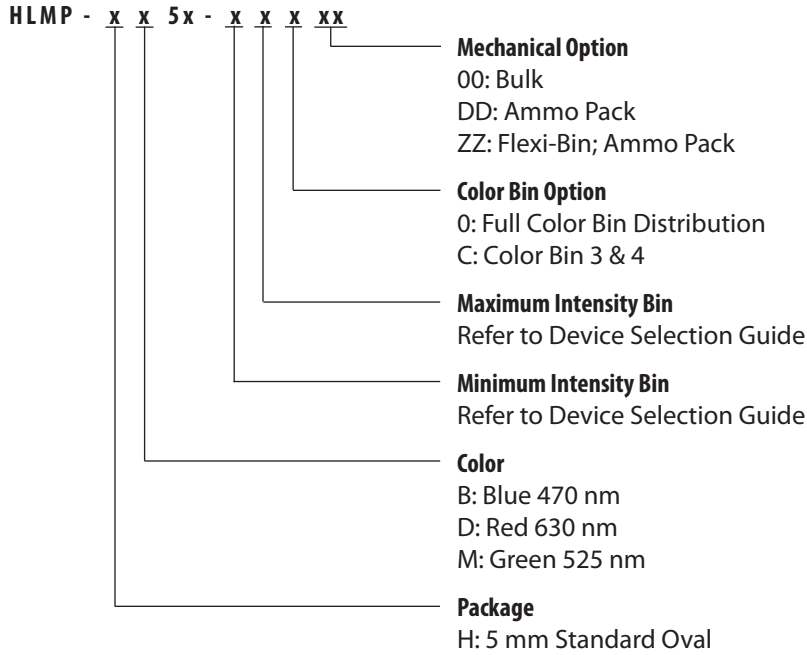

Note: Please refer to AB 5337 for complete information about part numbering system.

## Absolute Maximum Rating at $T_A = 25^\circ\text{C}$

Parameters	Blue and Green	Red	Unit
DC Forward Current <sup>[1]</sup>	30	50	mA
Peak Pulsed Forward Current	100 <sup>[2]</sup>	100 <sup>[3]</sup>	mA
Power Dissipation	116	120	mW
LED Junction Temperature	130	130	°C
Operating Temperature Range	-40 to +85	-40 to 100	°C
Storage Temperature Range	-40 to +100	-40 to 120	°C

### Notes:

1. Derate linearly as shown in Figures 2 and 7.
2. Duty factor 10%, frequency 1 KHz.
3. Duty factor 30%, frequency 1 KHz.

## Electrical/Optical Characteristics

$T_A = 25^\circ\text{C}$

Parameters	Symbol	Value			Units	Test Condition
		Min.	Typ.	Max.		
<b>Forward Voltage</b>	$V_F$				V	$I_F = 20\text{ mA}$
Red		2.0	2.20	2.40		
Green		2.8	3.30	3.85		
Blue		2.8	3.20	3.85		
<b>Reverse Voltage</b>	$V_R$				V	
Red		5.0				$I_R = 100\ \mu\text{A}$
Green, Blue		5.0				$I_R = 10\ \mu\text{A}$
<b>Capacitance</b>	C				pF	$V_F = 0, f = 1\text{ MHz}$
Red			40			
Green			65			
Blue			64			
<b>Thermal Resistance</b> <sup>[1]</sup>	$R_{\theta\text{J-PIN}}$		240		$^\circ\text{C/W}$	LED Junction-to-Pin
<b>Dominant Wavelength</b> <sup>[2,3]</sup>	$\lambda_d$				nm	$I_F = 20\text{ mA}$
Red		622	630	634		
Green		520	525	540		
Blue		460	470	480		
<b>Peak Wavelength</b>	$\lambda_{\text{PEAK}}$				nm	Peak of Wavelength of Spectral Distribution at $I_F = 20\text{ mA}$
Red			639			
Green			516			
Blue			464			
<b>Spectral Half Width</b>	$\Delta\lambda_{1/2}$				nm	Wavelength Width at Spectral Distribution 1/2 Power Point at $I_F = 20\text{ mA}$
Red			17			
Green			32			
Blue			23			
<b>Luminous Efficacy</b> <sup>[4]</sup>	$\eta_v$				lm/W	Emitted Luminous Power/Emitted Radiant Power
Red			155			
Green			520			
Blue			75			
<b>Luminous Flux</b>						
Red	$\phi_v$		1300		mlm	$I_F = 20\text{ mA}$
Green			3000			
Blue			600			
<b>Luminous Efficiency</b> <sup>[5]</sup>	$\eta_e$				lm/W	Luminous Flux/Electrical Power $I_F = 20\text{ mA}$
Red			30			
Green			50			
Blue			10			

### Notes:

1. For AlInGaP Red, the thermal resistance applied to LED junction to cathode lead. For InGaN Blue and Green, the thermal resistance applied to LED junction to anode lead.
2. The dominant wavelength,  $\lambda_d$ , is derived from the Chromaticity Diagram and represents the color of the lamp.
3. Tolerance for each color bin limit is  $\pm 0.5\text{ nm}$ .
4. The radiant intensity,  $I_e$  in watts/steradian, may be found from the equation  $I_e = I_v/\eta_v$ , where  $I_v$  is the luminous intensity in candelas and  $\eta_v$  is the luminous efficacy in lumens/watt.
5.  $\eta_e = \phi_v / I_F \times V_F$ , where  $\phi_v$  is the emitted luminous flux,  $I_F$  is electrical forward current and  $V_F$  is the forward voltage.

## AllnGaP Red

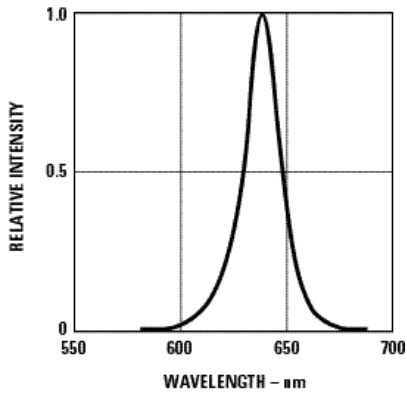

Figure 1. Relative intensity vs. wavelength.

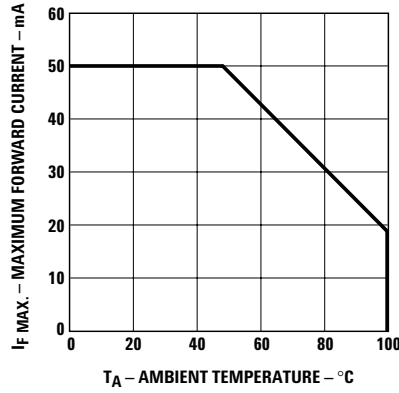

Figure 2. Forward current vs. ambient temperature.

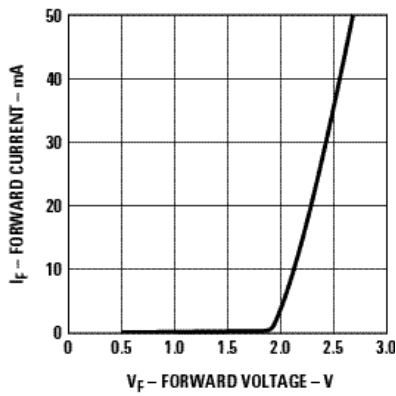

Figure 3. Forward current vs. forward voltage.

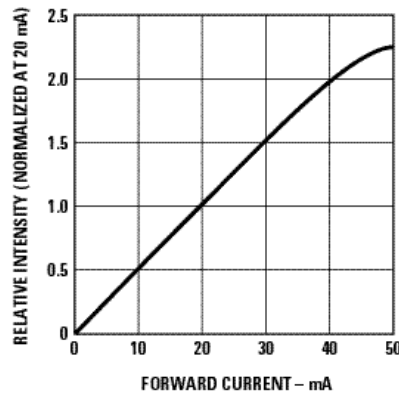

Figure 4. Relative luminous intensity vs. forward current.

## InGaN Blue and Green

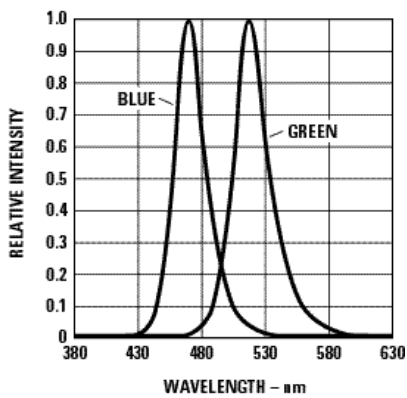

Figure 5. Relative intensity vs. wavelength.

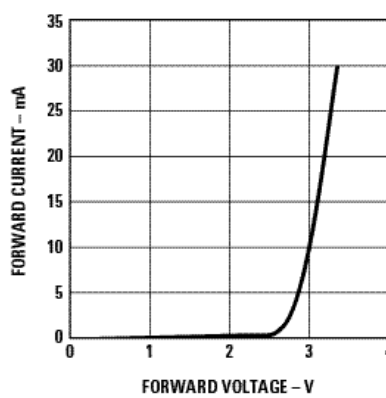

Figure 6. Forward current vs. forward voltage.

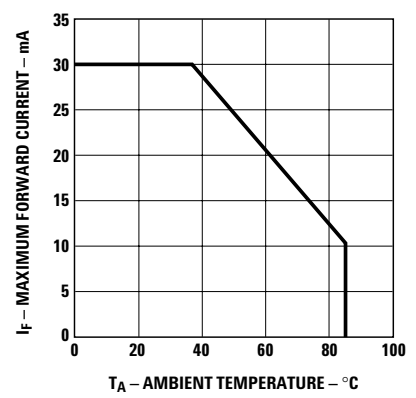

Figure 7. Maximum forward current vs. ambient temperature.

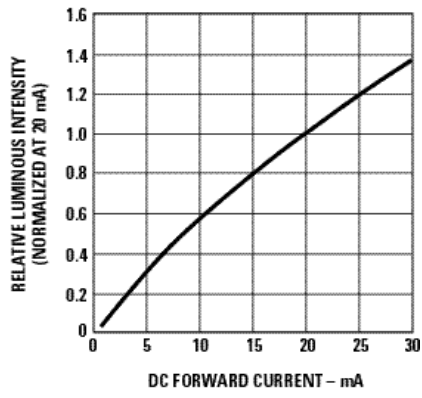

Figure 8. Relative intensity vs. forward current.

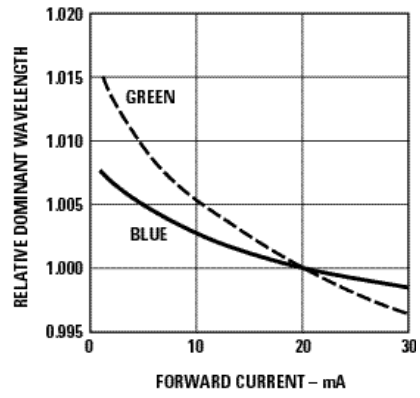

Figure 9. Relative dominant wavelength vs. DC forward current.

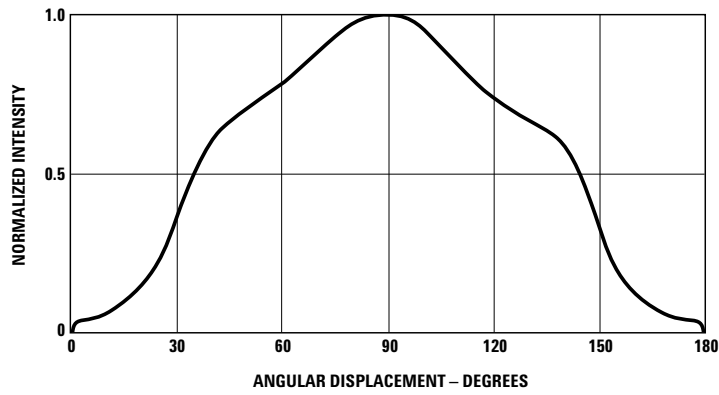

Figure 10. Spatial radiation pattern - major axis.

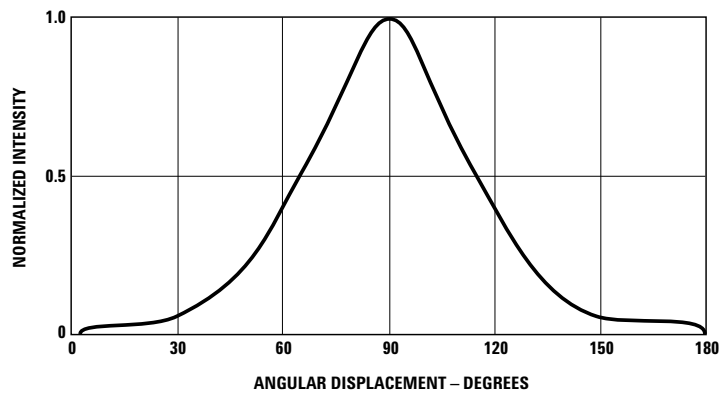

Figure 11. Spatial radiation pattern - minor axis.

### Intensity Bin Limit Table

Bin	Intensity (mcd) at 20 mA	
	Min	Max
K	310	400
L	400	520
M	520	680
N	680	880
P	880	1150
Q	1150	1500
R	1500	1900
S	1900	2500
T	2500	3200
U	3200	4200
V	4200	5500

Tolerance for each bin limit is  $\pm 15\%$ .

### Blue Color Bin Table

Bin	Min. Dom	Max. Dom	Xmin	Ymin	Xmax	Ymax
1	460.0	464.0	0.1440	0.0297	0.1766	0.0966
			0.1818	0.0904	0.1374	0.0374
2	464.0	468.0	0.1374	0.0374	0.1699	0.1062
			0.1766	0.0966	0.1291	0.0495
3	468.0	472.0	0.1291	0.0495	0.1616	0.1209
			0.1699	0.1062	0.1187	0.0671
4	472.0	476.0	0.1187	0.0671	0.1517	0.1423
			0.1616	0.1209	0.1063	0.0945
5	476.0	480.0	0.1063	0.0945	0.1397	0.1728
			0.1517	0.1423	0.0913	0.1327

Tolerance for each bin limit is  $\pm 0.5$  nm.

### Green Color Bin Table

Bin	Min. Dom	Max. Dom	Xmin	Ymin	Xmax	Ymax
1	520.0	524.0	0.0743	0.8338	0.1856	0.6556
			0.1650	0.6586	0.1060	0.8292
2	524.0	528.0	0.1060	0.8292	0.2068	0.6463
			0.1856	0.6556	0.1387	0.8148
3	528.0	532.0	0.1387	0.8148	0.2273	0.6344
			0.2068	0.6463	0.1702	0.7965
4	532.0	536.0	0.1702	0.7965	0.2469	0.6213
			0.2273	0.6344	0.2003	0.7764
5	536.0	540.0	0.2003	0.7764	0.2659	0.6070
			0.2469	0.6213	0.2296	0.7543

Tolerance for each bin limit is  $\pm 0.5$  nm.

### Red Color Range

Min. Dom	Max. Dom	Xmin	Ymin	Xmax	Ymax
622	634	0.6904	0.3094	0.6945	0.2888
		0.6726	0.3106	0.7135	0.2865

Tolerance for each bin limit is  $\pm 0.5$  nm.

### Avago Color Bin on CIE 1931 Diagram

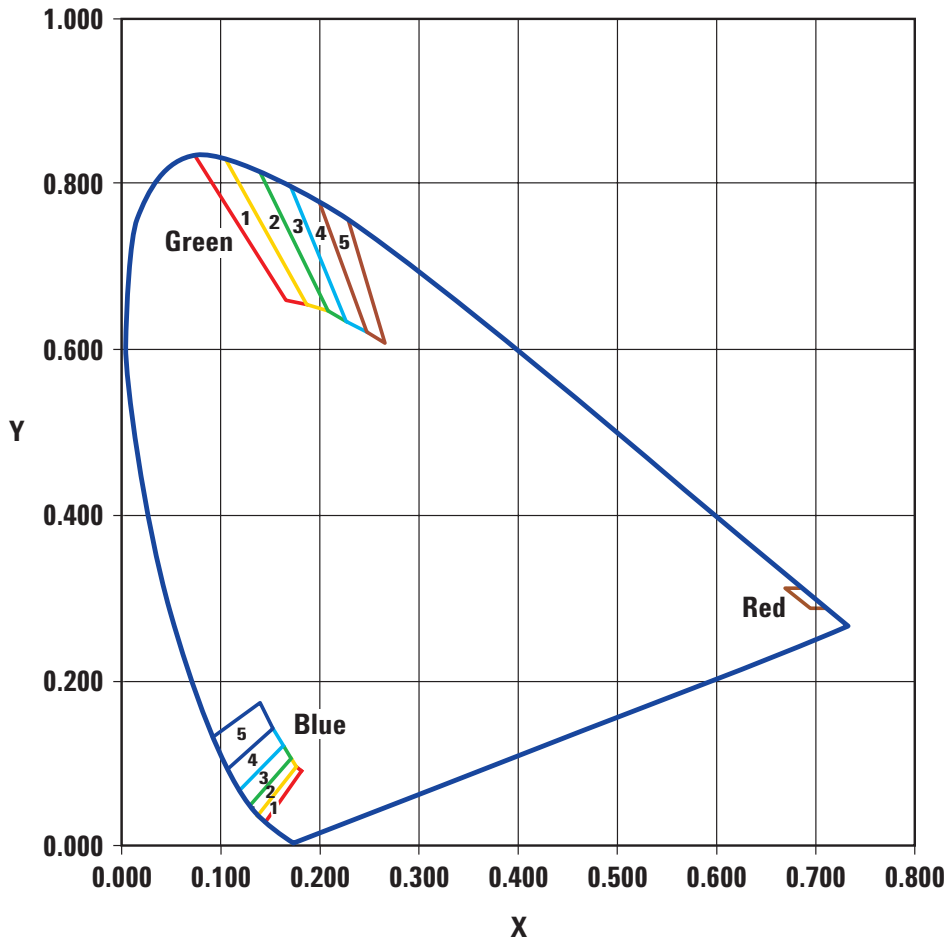

### Relative Light Output vs. Junction Temperature

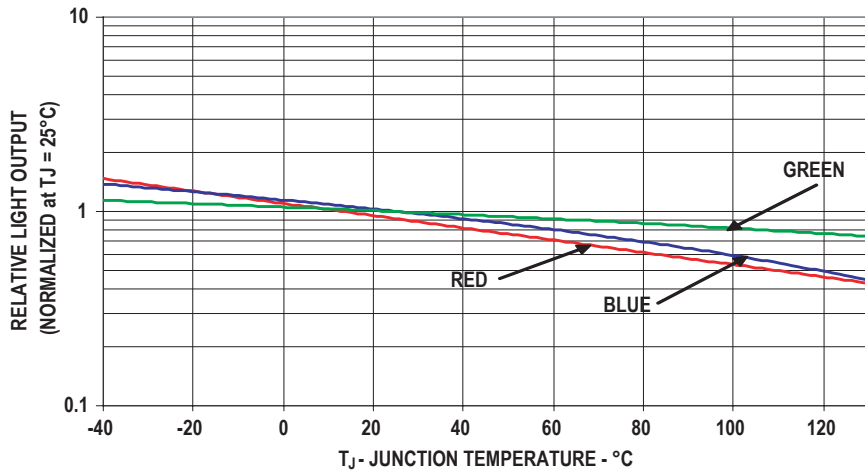



**Precautions:**

**Lead Forming:**

- The leads of an LED lamp may be preformed or cut to length prior to insertion and soldering on PC board.
- For better control, it is recommended to use proper tool to precisely form and cut the leads to applicable length rather than doing it manually.
- If manual lead cutting is necessary, cut the leads after the soldering process. The solder connection forms a mechanical ground which prevents mechanical stress due to lead cutting from traveling into LED package. This is highly recommended for hand solder operation, as the excess lead length also acts as small heat sink.

**Soldering and Handling:**

- Care must be taken during PCB assembly and soldering process to prevent damage to the LED component.
- LED component may be effectively hand soldered to PCB. However, it is only recommended under unavoidable circumstances such as rework. The closest manual soldering distance of the soldering heat source (soldering iron's tip) to the body is 1.59mm. Soldering the LED using soldering iron tip closer than 1.59mm might damage the LED.

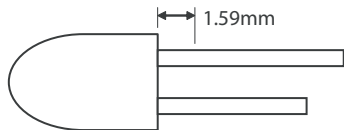

- ESD precaution must be properly applied on the soldering station and personnel to prevent ESD damage to the LED component that is ESD sensitive. Do refer to Avago application note AN 1142 for details. The soldering iron used should have grounded tip to ensure electrostatic charge is properly grounded.
- Recommended soldering condition:

	Wave Soldering [1,2]	Manual Solder Dipping
Pre-heat temperature	105 °C Max.	-
Preheat time	60 sec Max	-
Peak temperature	250 °C Max.	260 °C Max.
Dwell time	3 sec Max.	5 sec Max

Note:

- 1) Above conditions refers to measurement with thermocouple mounted at the bottom of PCB.
  - 2) It is recommended to use only bottom preheaters in order to reduce thermal stress experienced by LED.
- Wave soldering parameters must be set and maintained according to the recommended temperature and dwell time. Customer is advised to perform daily check on the soldering profile to ensure that it is always conforming to recommended soldering conditions.

Note:

1. PCB with different size and design (component density) will have different heat mass (heat capacity). This might cause a change in temperature experienced by the board if same wave soldering setting is used. So, it is recommended to re-calibrate the soldering profile again before loading a new type of PCB.
2. Avago Technologies' high brightness LED are using high efficiency LED die with single wire bond as shown below. Customer is advised to take extra precaution during wave soldering to ensure that the maximum wave temperature does not exceed 250°C and the solder contact time does not exceeding 3sec. Over-stressing the LED during soldering process might cause premature failure to the LED due to delamination.

**Avago Technologies LED configuration**

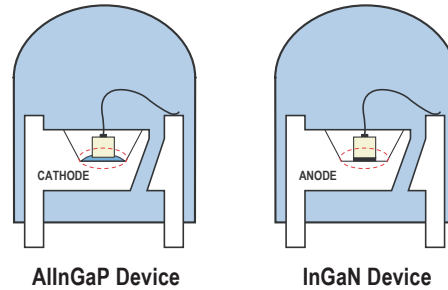

Note: Electrical connection between bottom surface of LED die and the lead frame is achieved through conductive paste.

- Any alignment fixture that is being applied during wave soldering should be loosely fitted and should not apply weight or force on LED. Non metal material is recommended as it will absorb less heat during wave soldering process.
- At elevated temperature, LED is more susceptible to mechanical stress. Therefore, PCB must allowed to cool down to room temperature prior to handling, which includes removal of alignment fixture or pallet.
- If PCB board contains both through hole (TH) LED and other surface mount components, it is recommended that surface mount components be soldered on the top side of the PCB. If surface mount need to be on the bottom side, these components should be soldered using reflow soldering prior to insertion the TH LED.
- Recommended PC board plated through holes (PTH) size for LED component leads.

LED component lead size	Diagonal	Plated through hole diameter
0.45 x 0.45 mm (0.018x0.018 inch)	0.636 mm (0.025 inch)	0.98 to 1.08 mm (0.039 to 0.043 inch)
0.50 x 0.50 mm (0.020x0.020 inch)	0.707 mm (0.028 inch)	1.05 to 1.15 mm (0.041 to 0.045 inch)

- Over-sizing the PTH can lead to twisted LED after clinching. On the other hand under sizing the PTH can cause difficulty inserting the TH LED.

Refer to application note AN5334 for more information about soldering and handling of high brightness TH LED lamps.

### Example of Wave Soldering Temperature Profile for TH LED

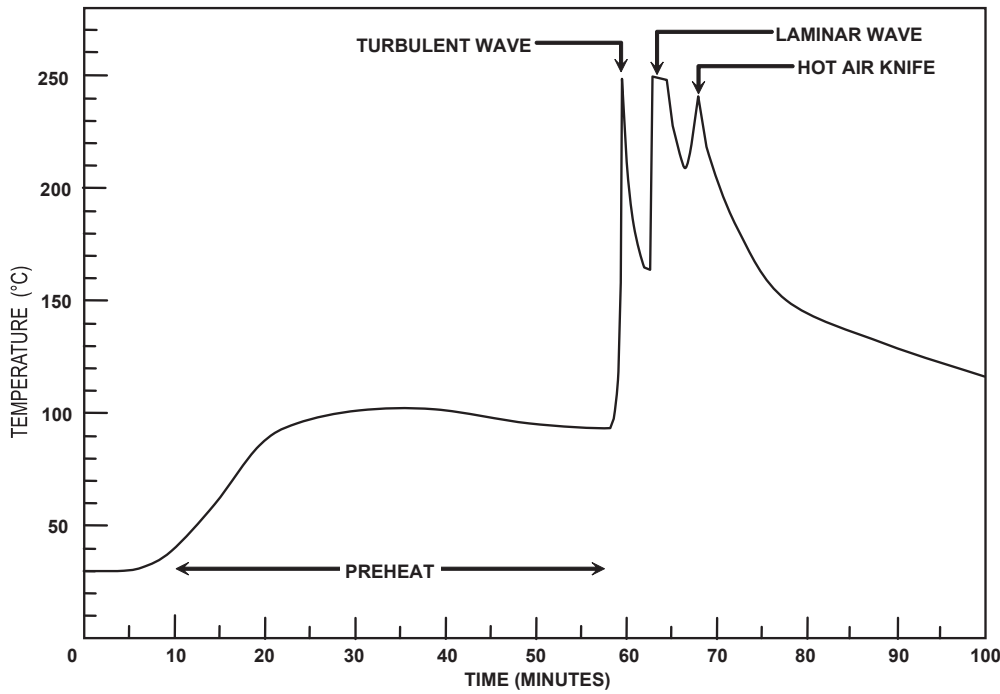

Recommended solder:  
Sn63 (Leaded solder alloy)  
SAC305 (Lead free solder alloy)

Flux: Rosin flux

Solder bath temperature:  
245°C ± 5°C (maximum peak  
temperature = 250°C)

Dwell time: 1.5 sec - 3.0 sec  
(maximum = 3sec)

Note: Allow for board to be sufficiently  
cooled to room temperature before  
exerting mechanical force.

### Ammo Packs Drawing

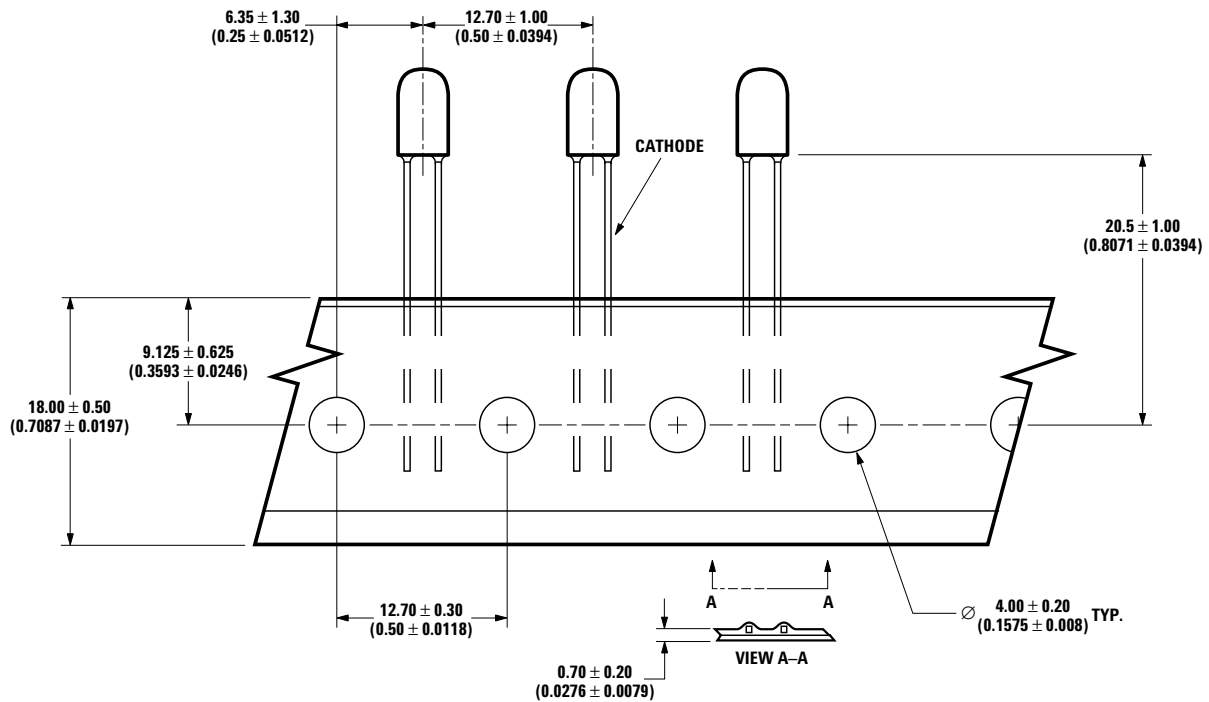

ALL DIMENSIONS IN MILLIMETERS (INCHES).

Note: The ammo-packs drawing is applicable for packaging option -DD & -ZZ and regardless of standoff or non-standoff.

## Packaging Box for Ammo Packs

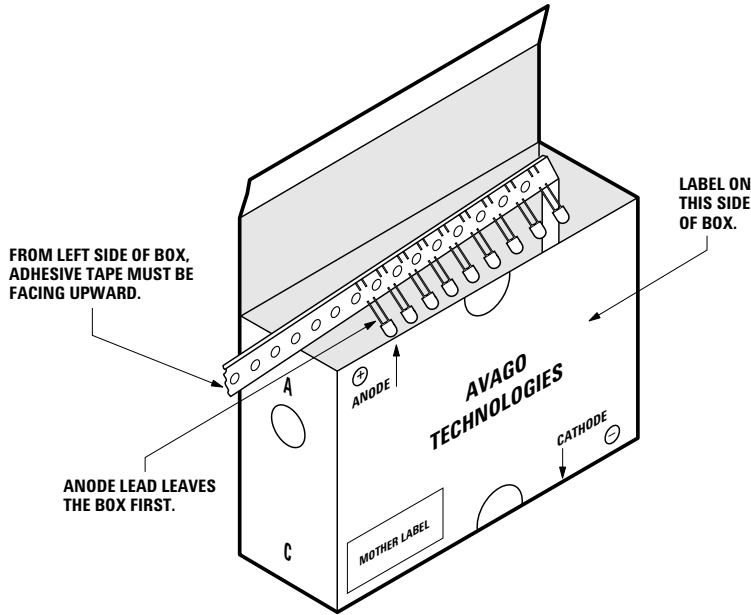











**Note:** For InGaN device, the ammo pack packaging box contains ESD logo.

## Packaging Label

(i) Avago Mother Label: (Available on packaging box of ammo pack and shipping box)

(1P) Item: <b>Part Number</b>		<b>Avago</b> TECHNOLOGIES
(1T) Lot: <b>Lot Number</b>		STANDARD LABEL LS0002
LPN		RoHS Compliant
(9D) MFG Date: <b>Manufacturing Date</b>		e1 max temp 250C
(P) Customer Item:		(Q) QTY: <b>Quantity</b>
(V) Vendor ID		CAT: <b>Intensity Bin</b>
Made In: <b>Country of Origin</b>		BIN: <b>Refer to below information</b>
		REV:
		DeptID:

(ii) Avago Baby Label (Only available on bulk packaging)

		RoHS Compliant e1 max temp 250C
PART #: Part Number		
LOT#: Lot Number		
MFG DATE: Manufacturing Date		QUANTITY: Packing Quantity
C/O: Country of Origin		
Customer P/N:		CAT: Intensity Bin
Supplier Code:		
		BIN: Refer to below information
		
		DATECODE: Date Code
		

**Acronyms and Definition:**

BIN:

(i) Color bin only or VF bin only

(Applicable for part number with color bins but without VF bin OR part number with VF bins and no color bin)

OR

(ii) Color bin incorporated with VF Bin

(Applicable for part number that have both color bin and VF bin)

**Example:**

(i) Color bin only or VF bin only

BIN: 2 (represent color bin 2 only)

BIN: VB (represent VF bin "VB" only)

(ii) Color bin incorporate with VF Bin

BIN: 2VB

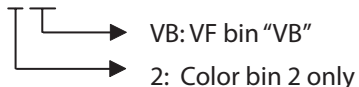

**DISCLAIMER:** AVAGO'S PRODUCTS AND SOFTWARE ARE NOT SPECIFICALLY DESIGNED, MANUFACTURED OR AUTHORIZED FOR SALE AS PARTS, COMPONENTS OR ASSEMBLIES FOR THE PLANNING, CONSTRUCTION, MAINTENANCE OR DIRECT OPERATION OF A NUCLEAR FACILITY OR FOR USE IN MEDICAL DEVICES OR APPLICATIONS. CUSTOMER IS SOLELY RESPONSIBLE, AND WAIVES ALL RIGHTS TO MAKE CLAIMS AGAINST AVAGO OR ITS SUPPLIERS, FOR ALL LOSS, DAMAGE, EXPENSE OR LIABILITY IN CONNECTION WITH SUCH USE.

For product information and a complete list of distributors, please go to our website: [www.avagotech.com](http://www.avagotech.com)

Avago, Avago Technologies, and the A logo are trademarks of Avago Technologies Limited in the United States and other countries. Data subject to change. Copyright © 2007 Avago Technologies Limited. All rights reserved. Obsoletes AV01-0305EN AV02-0371EN - July 6, 2007

