



**FRACTIONAL-N PLL WITH INTEGRATED VCO  
1050 -1205, 2100 - 2410, 4200 - 4820 MHz**

**Features**

- Tri-band RF Bandwidths: 1050 - 1205, 2100 - 2410, 4200 - 4820 MHz
- Ultra Low Phase Noise -112 dBc/Hz in Band Typ.
- Figure of Merit (FOM) -227 dBc/Hz
- < 180 fs RMS Jitter
- 24-bit Step Size, Resolution 3 Hz typ
- Exact Frequency Resolution Mode
- Built-In Digital Self Test
- 40 Lead 6x6 mm SMT Package: 36 mm<sup>2</sup>

**Typical Applications**

- Cellular/4G Infrastructure
- Repeaters and Femtocells
- Communications Test Equipment
- CATV Equipment
- Phased Array Applications
- DDS Replacement
- Very High Data Rate Radios

**Functional Diagram**



Information furnished by Analog Devices is believed to be accurate and reliable. However, no responsibility is assumed by Analog Devices for its use, nor for any infringements of patents or other rights of third parties that may result from its use. Specifications subject to change without notice. No license is granted by implication or otherwise under any patent or patent rights of Analog Devices. Trademarks and registered trademarks are the property of their respective owners.

For price, delivery, and to place orders: Analog Devices, Inc., One Technology Way, P.O. Box 9106, Norwood, MA 02062-9106 Phone: 781-329-4700 • Order online at [www.analog.com](http://www.analog.com) Application Support: Phone: 1-800-ANALOG-D



## FRACTIONAL-N PLL WITH INTEGRATED VCO 1050 -1205, 2100 - 2410, 4200 - 4820 MHz

### General Description

The HMC839LP6CE is a fully functioned Fractional-N Phase-Locked-Loop (PLL) with an Integrated Voltage Controlled Oscillator (VCO). The PLL consists of an integrated low noise VCO with a tri-band output, an autocalibration subsystem for low voltage VCO tuning, a very low noise digital Phase Detector (PD), a precision controlled charge pump, a low noise reference path divider and a fractional divider.

The fractional PLL features an advanced delta-sigma modulator design that allows both ultra-fine step sizes and low spurious products. The phase detector (PD) features cycle slip prevention (CSP) technology to allow faster frequency hopping times. Ultra low in-close phase noise and low spurious also allows wider loop bandwidths for faster frequency hopping and low micro-phonics.

For theory of operation and register map refer to the “PLLs with Integrated VCOs - RF VCOs Operating Guide”. To view the Operating Guide, please visit [www.hittite.com](http://www.hittite.com) and choose HMC839LP6CE from the “Search by Part Number” pull down menu.

**Electrical Specifications,  $T_A = +25^\circ\text{C}$ , VPPCP, VDDCP, VCC1, VCC2 = 5V  $\pm$ 4%; RVDD, AVDD, DVDD3V, VCCPD, VCCHF, VCCPS = 3.3V  $\pm$ 6% GNDCP = GNDLS = Ground Paddle = 0V, 100 MHz Reference Unless Otherwise Noted.**

Parameter	Condition	Min.	Typ.	Max.	Units
<b>RF Output Characteristics</b>					
VCO Frequency at PLL Input		2100	2200	2410	MHz
RF Output Frequency at $f_{VCO}/2$		1050	1100	1205	MHz
RF Output Frequency at $f_{VCO}$		2100	2200	2410	MHz
RF Output Frequency at $2f_{VCO}$		4200	4400	4820	MHz
RF Output Power at $f_{VCO}/2$		7.5	10	12.5	dBm
RF Output Power at $f_{VCO}$		3.5	7	12	dBm
RF Output Power at $2f_{VCO}$		-9	-4	1	dBm
VCO Tuning Sensitivity	Measured at $f_o$ , 2V (N= 0/15/31)	10	13	18	MHz/V
VCO Supply Pushing	Measured at $f_o$ , 2V		1.6		MHz/V
RF Output $f_o/2$ Harmonic	Doubler Mode		-26		dBc
RF Output $3f_o/2$ Harmonic	Doubler Mode		-35		dBc
RF Output 2nd Harmonic	$f_o/2/f_o/2f_o$		-23 / -28 / -41		dBc
RF Output $5f_o/2$ Harmonic	Doubler Mode		-48		dBc
RF Output 3rd Harmonic	$f_o/2/f_o/2f_o$		-30 / -34 / -55		dBc
RF Output $7f_o/2$ Harmonic	Doubler Mode		-55		dBc
RF Output 4th Harmonic	$f_o/2/f_o/2f_o$		-32 / -52 / -58		dBc
<b>RF Divider Characteristics</b>					
19-Bit N-Divider Range (Integer)	Max = $2^{19} - 1$	16		524,287	
19-Bit N-Divider Range (Fractional)	Fractional nominal divide ratio varies (-3 / +3) dynamically max	20		524,283	
<b>REF Input Characteristics</b>					
Ref Input Frequency	Synthesizer phase noise can degrade by about 5dB when operating with a reference frequency near the low end of this range.	10	50	200	MHz
Ref Input Range	AC Coupled	1	2	3.3	Vp-p
Ref Input Capacitance				5	pF
14-Bit R-Divider Range		1		16,383	

Information furnished by Analog Devices is believed to be accurate and reliable. However, no responsibility is assumed by Analog Devices for its use, nor for any infringements of patents or other rights of third parties that may result from its use. Specifications subject to change without notice. No license is granted by implication or otherwise under any patent or patent rights of Analog Devices. Trademarks and registered trademarks are the property of their respective owners.

For price, delivery, and to place orders: Analog Devices, Inc., One Technology Way, P.O. Box 9106, Norwood, MA 02062-9106 Phone: 781-329-4700 • Order online at [www.analog.com](http://www.analog.com) Application Support: Phone: 1-800-ANALOG-D



## FRACTIONAL-N PLL WITH INTEGRATED VCO 1050 -1205, 2100 - 2410, 4200 - 4820 MHz

### Electrical Specifications (Continued)

Parameter	Condition	Min.	Typ.	Max.	Units
<b>Phase Detector (PD)</b>					
PD Frequency Fractional Feedback Mode	[1]	0.1		100	MHz
PD Frequency Fractional Feedforward Mode (and Register 6 [17:16] = 10)		0.1		80	MHz
PD Frequency Integer Mode	[1]	0.1		125	MHz
<b>Charge Pump</b>					
Output Current		0.02		2.54	mA
Charge Pump Gain Step Size			20		μA
PD/Charge Pump SSB Phase Noise	Input Referred, Maximum CP Current				
100 Hz			-132		dBc/Hz
1 kHz			-142		dBc/Hz
10 kHz	Add 1 dB for Fractional	-151	-149	-147	dBc/Hz
100 kHz	Add 3 dB for Fractional	-155	-153	-151	dBc/Hz
<b>Logic Inputs</b>					
VIH Output High Voltage		DVDD3V-0.4		DVDD3V	V
VIL Output Low Voltage		0		0.4	V
<b>Logic Outputs</b>					
VOH Output High Voltage		DVDD3V-0.4		DVDD3V	V
VOL Output Low Voltage		0		0.4	V
<b>Power Supply Voltages</b>					
Analog 3.3V Supplies	AVDD, VCCHF, VCCPS, VCCPD, RVDD	3.0	3.3	3.5	V
Digital Supply	DVDD3V	3.0	3.3	3.5	V
Analog 5V Supplies	VPPCP, VDDCP, VCC1, VCC2	4.8	5	5.2	V
<b>Power Supply Currents</b>					
+5V Analog Charge Pump	VPPCP, VDDCP		5.3		mA
+5V VCO, PLL Buffer and RF Buffer	VCC1 + VCC2 (fo / 2 / fo / 2fo)		89 / 73 / 72		mA
+3.3V Analog	AVDD, VCCHF, VCCPS, VCCPD, RVDD		45		mA
+3.3V Digital	DVDD3V		6.5		mA
Power Down - Crystal Off	Reg 01h=0, Crystal Not Clocked		10		μA
Power Down - Crystal On, 100 MHz	Reg 01h=0, Crystal Clocked 100 MHz		10	200	μA
<b>Power on Reset</b>					
Typical Reset Voltage on DVDD			700		mV
Min DVDD Voltage for No Reset		1.5			V
Power on Reset Delay			250		μs
<b>VCO Open Loop Phase Noise at fo/2</b>					
10 kHz Offset			-91		dBc/Hz
100 kHz Offset			-121		dBc/Hz
1 MHz Offset			-146		dBc/Hz

Note 1: This maximum phase detector frequency can only be achieved if the minimum N value is respected. eg. In the case of fractional feedback mode, the maximum PFD rate =  $f_{vco}/20$  or 100 MHz, whichever is less.

Information furnished by Analog Devices is believed to be accurate and reliable. However, no responsibility is assumed by Analog Devices for its use, nor for any infringements of patents or other rights of third parties that may result from its use. Specifications subject to change without notice. No license is granted by implication or otherwise under any patent or patent rights of Analog Devices. Trademarks and registered trademarks are the property of their respective owners.

For price, delivery, and to place orders: Analog Devices, Inc., One Technology Way, P.O. Box 9106, Norwood, MA 02062-9106  
Phone: 781-329-4700 • Order online at [www.analog.com](http://www.analog.com)  
Application Support: Phone: 1-800-ANALOG-D



## FRACTIONAL-N PLL WITH INTEGRATED VCO 1050 -1205, 2100 - 2410, 4200 - 4820 MHz

### Electrical Specifications (Continued)

Parameter	Condition	Min.	Typ.	Max.	Units
10 MHz Offset			-162		dBc/Hz
100 MHz Offset			-163		dBc/Hz
<b>VCO Open Loop Phase Noise at fo</b>					
10 kHz Offset			-85		dBc/Hz
100 kHz Offset			-116		dBc/Hz
1 MHz Offset			-140		dBc/Hz
10 MHz Offset			-161		dBc/Hz
100 MHz Offset			-166		dBc/Hz
<b>VCO Open Loop Phase Noise at 2fo</b>					
10 kHz Offset			-80		dBc/Hz
100 kHz Offset			-109		dBc/Hz
1 MHz Offset			-135		dBc/Hz
10 MHz Offset			-155		dBc/Hz
100 MHz Offset			-158		dBc/Hz
<b>Closed Loop Phase Noise PLL + VCO at fvco/2</b>					
Integer, 100 MHz PD	1 kHz Offset		-117		dBc/Hz
Integer, 100 MHz PD	10 kHz Offset		-121		dBc/Hz
Integer, 100 MHz PD	100 kHz Offset		-121		dBc/Hz
Fractional, 100 MHz PD	1 kHz Offset		-113		dBc/Hz
Fractional, 100 MHz PD	10 kHz Offset		-116		dBc/Hz
Fractional, 100 MHz PD	100 kHz Offset		-117		dBc/Hz
<b>Closed Loop Phase Noise PLL + VCO at fvco</b>					
Integer, 100 MHz PD	1 kHz Offset		-109		dBc/Hz
Integer, 100 MHz PD	10 kHz Offset		-115		dBc/Hz
Integer, 100 MHz PD	100 kHz Offset		-112		dBc/Hz
Fractional, 100 MHz PD	1 kHz Offset		-106		dBc/Hz
Fractional, 100 MHz PD	10 kHz Offset		-110		dBc/Hz
Fractional, 100 MHz PD	100 kHz Offset		-114		dBc/Hz
<b>Closed Loop Phase Noise PLL + VCO at 2fo</b>					
Integer, 100 MHz PD	1 kHz Offset		-103		dBc/Hz
Integer, 100 MHz PD	10 kHz Offset		-108		dBc/Hz
Integer, 100 MHz PD	100 kHz Offset		-107		dBc/Hz
Fractional, 100 MHz PD	1 kHz Offset		-100		dBc/Hz
Fractional, 100 MHz PD	10 kHz Offset		-104		dBc/Hz
Fractional, 100 MHz PD	100 kHz Offset		-106		dBc/Hz
<b>Synthesizer Figure of Merit</b>					
	Normalized 1 Hz				
Integer Mode	Measured w/ 50 MHz PD at 30 kHz Offset		-229		dBc/Hz
Fractional Mode	Measured w/ 50 MHz PD at 30 kHz Offset		-227		dBc/Hz



**FRACTIONAL-N PLL WITH INTEGRATED VCO  
1050 -1205, 2100 - 2410, 4200 - 4820 MHz**

PLLS W/ INTEGRATED VCO - SMT

**Closed Loop Integer Phase Noise**

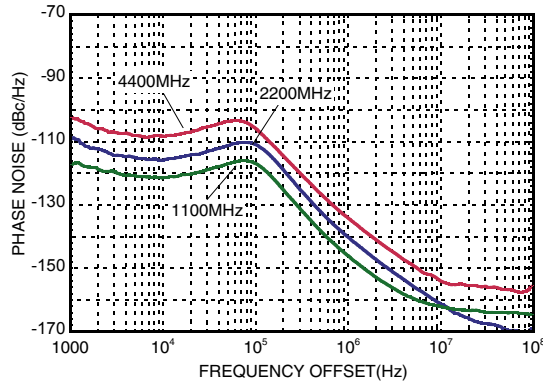

**Typical Closed Loop Fractional Phase Noise [1]**

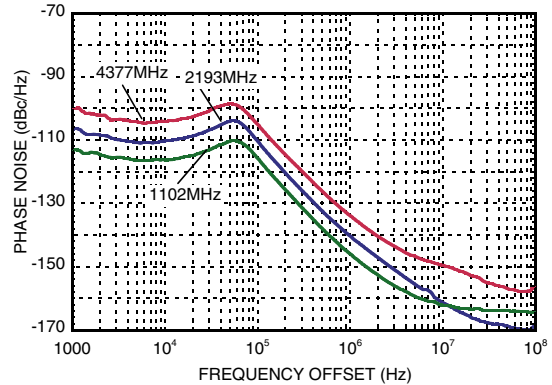

**Free Running Phase Noise**

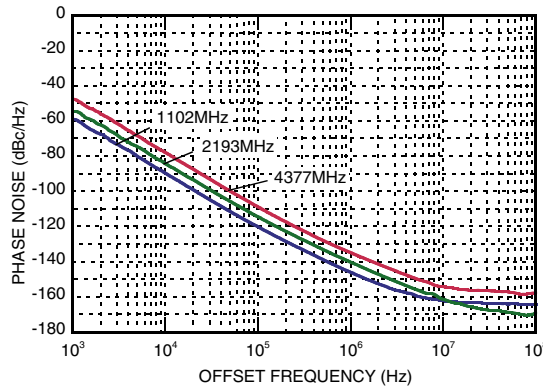

**Typical Tuning Curves vs. Switch Position**

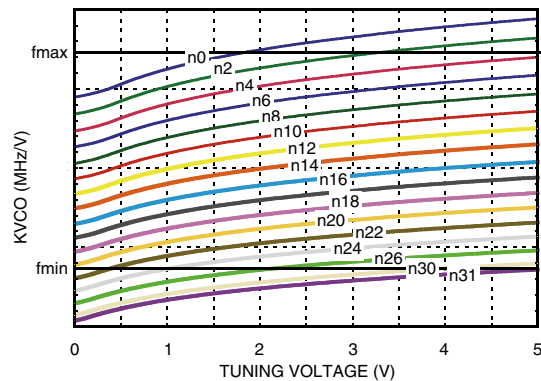

**Free Running VCO Phase Noise Over Temperature**



**Typical VCO Tuning Voltage After Calibration**

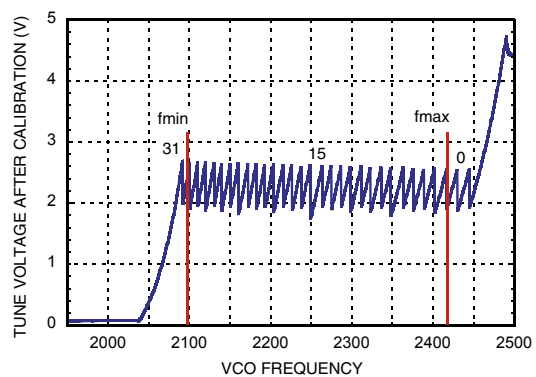

[1] Fractional Mode, 100 MHz Crystal, R=1

**FRACTIONAL-N PLL WITH INTEGRATED VCO  
1050 -1205, 2100 - 2410, 4200 - 4820 MHz**



**Typical VCO Sensitivity vs. Cap @ Fo Voltage**



**Typical Spurious @ 200 kHz from Integer Boundary**



**Typical Output Power - Narrow Band Match**

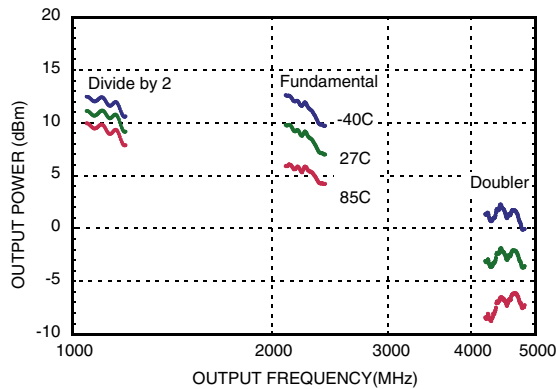

**Figure of Merit**

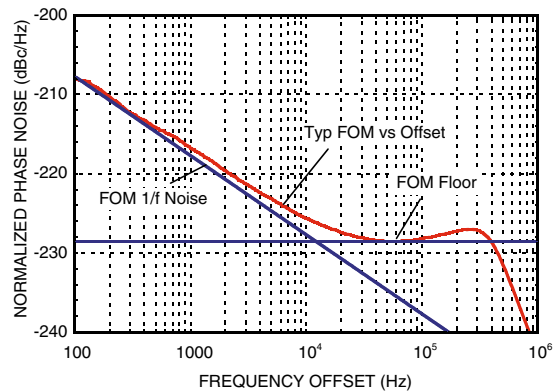

Information furnished by Analog Devices is believed to be accurate and reliable. However, no responsibility is assumed by Analog Devices for its use, nor for any infringements of patents or other rights of third parties that may result from its use. Specifications subject to change without notice. No license is granted by implication or otherwise under any patent or patent rights of Analog Devices. Trademarks and registered trademarks are the property of their respective owners.

For price, delivery, and to place orders: Analog Devices, Inc., One Technology Way, P.O. Box 9106, Norwood, MA 02062-9106 Phone: 781-329-4700 • Order online at [www.analog.com](http://www.analog.com) Application Support: Phone: 1-800-ANALOG-D

**FRACTIONAL-N PLL WITH INTEGRATED VCO  
1050 -1205, 2100 - 2410, 4200 - 4820 MHz**
**Pin Descriptions**

Pin Number	Function	Description
1	AVDD	DC Power Supply for analog circuitry.
2, 5, 6, 8, 9, 11 - 14, 18 - 22, 24, 26, 34, 37, 38	N/C	The pins are not connected internally; however, all data shown herein was measured with these pins connected to RF/DC ground externally.
3	VPPCP	Power Supply for charge pump analog section
4	CP	Charge Pump Output
7	VDDCP	Power Supply for the charge pump digital section
10	RVDD	Reference Supply
15	XREFP	Reference Oscillator Input
16	DVDD3V	DC Power Supply for Digital (CMOS) Circuitry
17	CEN	Chip Enable. Connect to logic high for normal operation.
23	VTUNE	VCO Varactor. Tuning Port Input.
25	VCC2	VCO Analog Supply 2
27	VCC1	VCO Analog Supply 1
28	RF_N <sup>[1]</sup>	RF Positive Output
29	RF_P <sup>[1]</sup>	RF Negative Output
30	SEN	PLL Serial Port Enable (CMOS) Logic Input
31	SDI	PLL Serial Port Data (CMOS) Logic Input
32	SCK	PLL Serial Port Clock (CMOS) Logic Input
33	LD_SDO	Lock Detect, or Serial Data, or General Purpose (CMOS) Logic Output (GPO)
35	VCCHF	DC Power Supply for Analog Circuitry
36	VCCPS	DC Power Supply for Analog Prescaler
39	VCCPD	DC Power Supply for Phase Detector
40	BIAS	External bypass decoupling for precision bias circuits. Note: 1.920V $\pm$ 20mV reference voltage (BIAS) is generated internally and cannot drive an external load. Must be measured with 10G $\Omega$ meter such as Agilent 34410A, normal 10M $\Omega$ DVM will read erroneously.

[1] For doubler mode of operation, pin 28 (RF\_N) and pin 29 (RF\_P) outputs must be shorted together.



## FRACTIONAL-N PLL WITH INTEGRATED VCO 1050 -1205, 2100 - 2410, 4200 - 4820 MHz

### Absolute Maximum Ratings

AVDD, RVDD, DVDD3V, VCCPD, VCCHF, VCCPS	-0.3V to +3.6V
VPPCP, VDDCP, VCC1	-0.3V to +5.8V
VCC2	-0.3V to +5.5V
Operating Temperature	-40°C to +85°C
Storage Temperature	-65°C to 125°C
Maximum Junction Temperature	125 °C
Thermal Resistance (R <sub>TH</sub> ) (junction to ground paddle)	20 °C/W
Reflow Soldering	
Peak Temperature	260°C
Time at Peak Temperature	40 sec
ESD Sensitivity (HBM)	Class 1B

Stresses above those listed under Absolute Maximum Ratings may cause permanent damage to the device. This is a stress rating only; functional operation of the device at these or any other conditions above those indicated in the operational section of this specification is not implied. Exposure to absolute maximum rating conditions for extended periods may affect device reliability.

### Outline Drawing

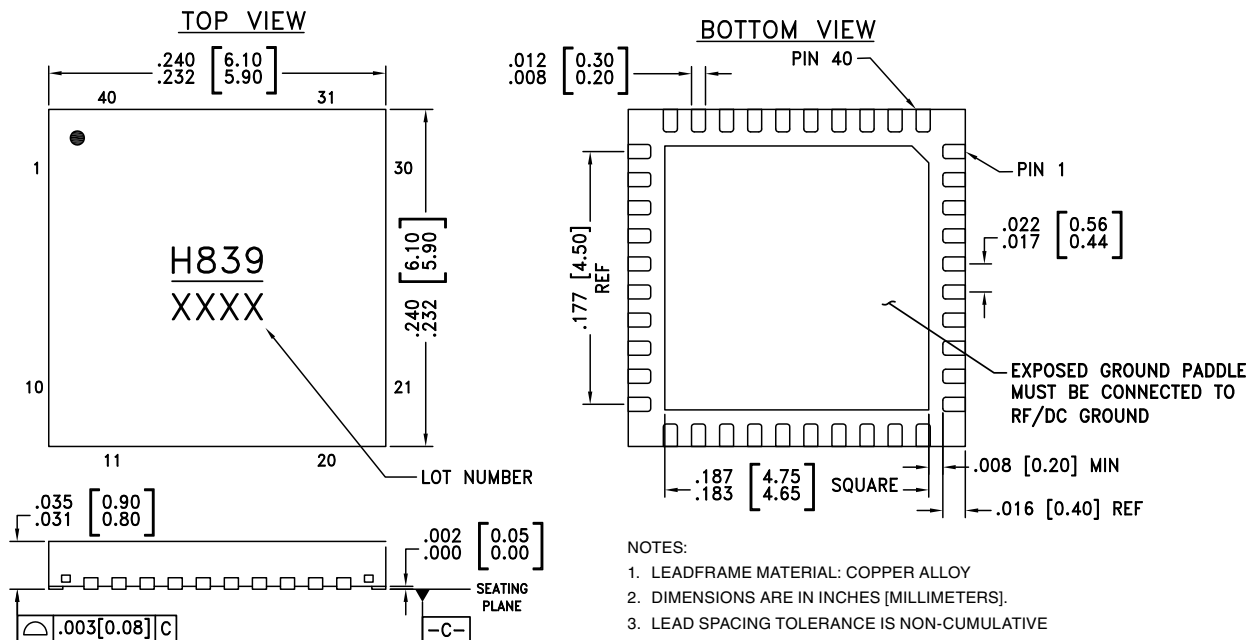

**NOTES:**

- LEADFRAME MATERIAL: COPPER ALLOY
- DIMENSIONS ARE IN INCHES [MILLIMETERS].
- LEAD SPACING TOLERANCE IS NON-CUMULATIVE
- PAD BURR LENGTH SHALL BE 0.15mm MAXIMUM.  
PAD BURR HEIGHT SHALL BE 0.05mm MAXIMUM.
- PACKAGE WARP SHALL NOT EXCEED 0.05mm.
- ALL GROUND LEADS AND GROUND PADDLE MUST BE SOLDERED TO PCB RF GROUND.
- REFER TO HITTITE APPLICATION NOTE FOR SUGGESTED PCB LAND PATTERN.

### Package Information

Part Number	Package Body Material	Lead Finish	MSL Rating	Package Marking <sup>[1]</sup>
HMC839LP6CE	RoHS-compliant Low Stress Injection Molded Plastic	100% matte Sn	MSL1	H839 XXXX

[1] 4-Digit lot number XXXX





**FRACTIONAL-N PLL WITH INTEGRATED VCO  
1050 -1205, 2100 - 2410, 4200 - 4820 MHz**

**Evaluation PCB, fo & fo/2 Modes**

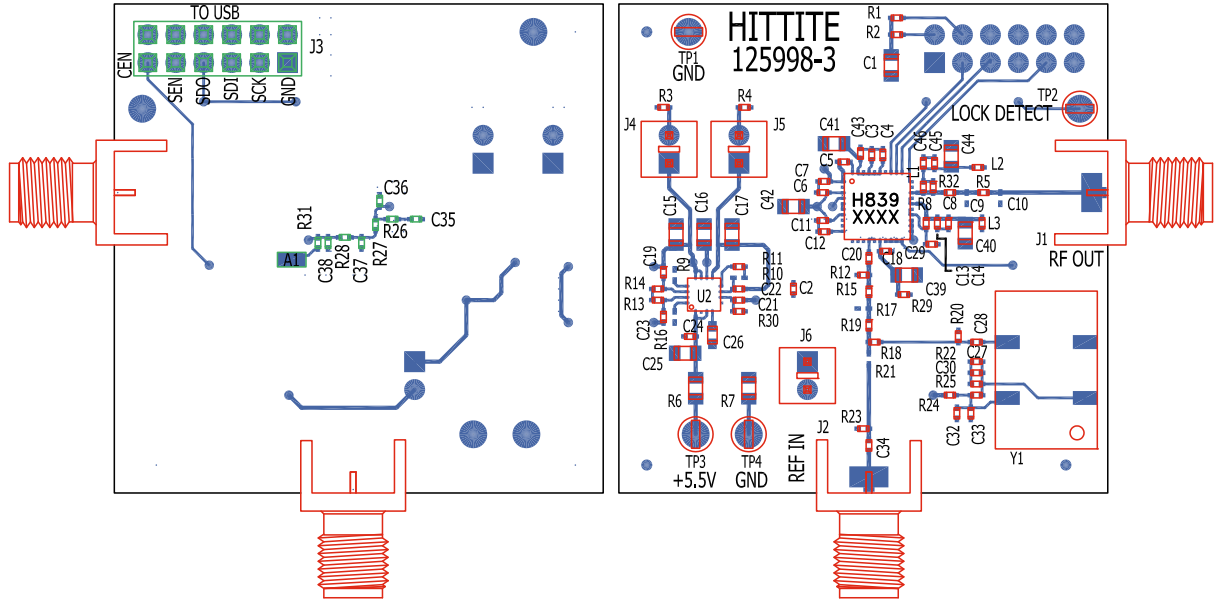

The circuit board used in the application should use RF circuit design techniques. Signal lines should have 50 Ohm impedance while the package ground leads and exposed paddle should be connected directly to the ground plane similar to that shown. A sufficient number of via holes should be used to connect the top and bottom ground planes. The evaluation circuit board shown is available from Hittite upon request.

**Evaluation PCB Schematic**

To view this [Evaluation PCB Schematic](http://www.hittite.com) please visit [www.hittite.com](http://www.hittite.com) and choose HMC839LP6CE from the "Search by Part Number" pull down menu to view the product splash page.

**FRACTIONAL-N PLL WITH INTEGRATED VCO  
1050 -1205, 2100 - 2410, 4200 - 4820 MHz**
**List of Materials for  
Evaluation PCB 129513, fo & fo/2 Modes [1]**

Item	Description
J1, J2	PCB Mount SMA RF Connector
J3	Dual Row Terminal Strip
J4 - J6	Connector Header
C1, C15 - C17, C25	10 $\mu$ F Capacitor, 0805 Pkg.
C2, C3, C6, C7, C11, C12, C14, C18, C27, C43, C45	0.47 $\mu$ F Capacitor, 0402 Pkg.
C4, C13	22 pF Capacitor, 0402 Pkg.
C5, C33	1000 pF Capacitor, 0402 Pkg.
C8	3.9 pF Capacitor, 0402 Pkg.
C19 - C24, C28, C30, C32, C34	0.1 $\mu$ F Capacitor, 0402 Pkg.
C26	1 $\mu$ F Capacitor, 0603 Pkg.
C29	47 pF Capacitor, 0402 Pkg.
C35	3300 pF Capacitor, 0402 Pkg.
C36	270 pF Capacitor, 0402 Pkg.
C37, C38	68 pF Capacitor, 0402 Pkg.
C39 - C42, C44	4.7 $\mu$ F Tantalum Capacitor, 0805 Pkg
R1, R2, R5, R8, R11, R15, R18, R19, R21, R24	0 Ohm Resistor, 0402 Pkg.
R3, R4	1 Ohm Resistor, 0402 Pkg.
R6, R7	0 Ohm Resistor, 0805 Pkg.
R12, R20, R29	51 Ohm Resistor, 0402 Pkg.
R22, R25	20 kOhm Resistor, 0402 Pkg.
R26 - R28	1k Ohm Resistor, 0402 Pkg.
L1	3.9 nH Inductor, 0402 Pkg.
TP3, TP4	Test Point PC Compact SMT
U1	HMC839LP6CE PLL with Integrated VCO
U2	HMC860LP3E Low Noise Quad Linear Regulator
Y1	3.3V, 50 MHz VCXO Crystal Oscillator
PCB [2]	125998 Evaluation Board

[1] Reference this number when ordering complete evaluation PCB

[2] Circuit Board Material: Rogers 4350 or Arlon 25FR and FR4



**FRACTIONAL-N PLL WITH INTEGRATED VCO  
1050 -1205, 2100 - 2410, 4200 - 4820 MHz**

**Evaluation PCB, 2xfo Mode**



The circuit board used in the application should use RF circuit design techniques. Signal lines should have 50 Ohm impedance while the package ground leads and exposed paddle should be connected directly to the ground plane similar to that shown. A sufficient number of via holes should be used to connect the top and bottom ground planes. The evaluation circuit board shown is available from Hittite upon request.

**Evaluation PCB Schematic**

To view this [Evaluation PCB Schematic](http://www.hittite.com) please visit [www.hittite.com](http://www.hittite.com) and choose HMC839LP6CE from the "Search by Part Number" pull down menu to view the product splash page.

**FRACTIONAL-N PLL WITH INTEGRATED VCO  
1050 -1205, 2100 - 2410, 4200 - 4820 MHz**
**List of Materials for  
Evaluation PCB 129514, 2xfo Mode [1]**

Item	Description
J1, J2	PCB Mount SMA RF Connector
J3	Dual Row Terminal Strip
J4 - J6	Connector Header
C1, C15 - C17, C25	10 $\mu$ F Capacitor, 0805 Pkg.
C2, C3, C6, C7, C11, C12, C14, C18, C27, C43, C45	0.47 $\mu$ F Capacitor, 0402 Pkg.
C4, C13	22 pF Capacitor, 0402 Pkg.
C5, C33	1000 pF Capacitor, 0402 Pkg.
C8	8.2 pF Capacitor, 0402 Pkg.
C19 - C24, C28, C30, C32, C34	0.1 $\mu$ F Capacitor, 0402 Pkg.
C26	1 $\mu$ F Capacitor, 0603 Pkg.
C29	1 pF Capacitor, 0402 Pkg.
C31	0.7 pF Capacitor, 0402 Pkg.
C35	3300 pF Capacitor, 0402 Pkg.
C36	270 pF Capacitor, 0402 Pkg.
C37, C38	68 pF Capacitor, 0402 Pkg.
C39 - C42, C44	4.7 $\mu$ F Tantalum Capacitor, 0805 Pkg
C46	27 pF Capacitor, 0402 Pkg.
C47	47 pF Capacitor, 0402 Pkg.
R1, R2, R8, R11, R15, R18, R19, R21, R24	0 Ohm Resistor, 0402 Pkg.
R3, R4	1 Ohm Resistor, 0402 Pkg.
R12, R20, R29	51 Ohm Resistor, 0402 Pkg.
R13, R14, R30	220 kOhm Resistor, 0402 Pkg.
R22, R25	20 kOhm Resistor, 0402 Pkg.
R26 - R28	1 kOhm Resistor, 0402 Pkg.
R31	0 Ohm Resistor, 0201 Pkg.
R32, R33	0 Ohm Resistor, 0805 Pkg.
L1	15 nH Inductor, 0402 Pkg.
L2, L3	47 nH Inductor, 0402 Pkg.
L4	0 Ohm Resistor, 0402 Pkg.
TP3, TP4	Test Point PC Compact SMT
U1	HMC839LP6CE PLL with Integrated VCO
U2	HMC860LP3E Low Noise Quad Linear Regulator
Y1	3.3V, 50 MHz VCXO Crystal Oscillator
PCB [2]	127729 Evaluation Board

[1] Reference this number when ordering complete evaluation PCB

[2] Circuit Board Material: Rogers 4350 or Arlon 25FR and FR4