

# HOA0708/0709

## Reflective Sensor

### FEATURES

- Choice of phototransistor or photodarlington output
- Focused for maximum response
- Ambient light and dust protective filter
- Adjustable mounting slot

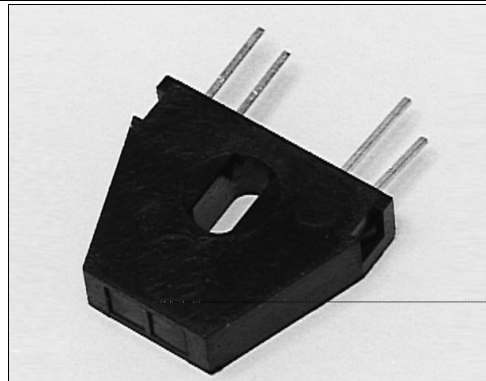

INFRA-56.TIF

### DESCRIPTION

The HOA0708/0709 series consists of an infrared emitting diode and an NPN silicon phototransistor (HOA0708-001, -011) or photodarlington (HOA0709-001, -011) encased side-by-side on converging optical axes in a black thermoplastic housing. The detector responds to radiation from the IRED only when a reflective object passes within its field of view. The HOA0708-011 and HOA0709-011 employ an IR transmissive filter to minimize the effects of visible ambient light and provide a smooth optical face which prevents the accumulation of airborne contaminants in the optical path. The HOA0708/0709 series employs plastic molded components. For additional component information see SEP8505, SDP8405, and SDP8105.

Housing material is polycarbonate. Housings are soluble in chlorinated hydrocarbons and ketones. Recommended cleaning agents are methanol and isopropanol.

### OUTLINE DIMENSIONS in inches (mm)

Tolerance 3 plc decimals  $\pm 0.010(0.25)$   
2 plc decimals  $\pm 0.020(0.51)$

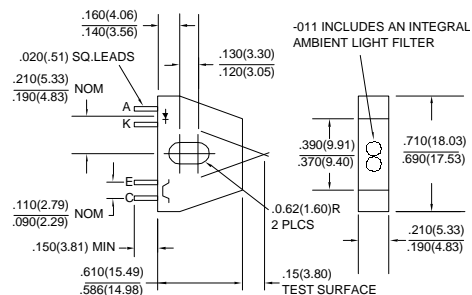

DIM\_033.dwg

# HOA0708/0709

## Reflective Sensor

### ELECTRICAL CHARACTERISTICS (25°C unless otherwise noted)

| PARAMETER                            | SYMBOL        | MIN | TYP | MAX | UNITS         | TEST CONDITIONS   |
|--------------------------------------|---------------|-----|-----|-----|---------------|---|
| <b>IR EMITTER</b>                    |               |     |     |     |               |   |
| Forward Voltage                      | $V_F$         |     |     | 1.6 | V             | $I_F=20\text{ mA}$  |
| Reverse Leakage Current              | $I_R$         |     |     | 10  | $\mu\text{A}$ | $V_R=3\text{ V}$  |
| <b>DETECTOR</b>                      |               |     |     |     |               |   |
| Collector-Emitter Breakdown Voltage  | $V_{(BR)CEO}$ |     |     |     | V             | $I_C=100\ \mu\text{A}$  |
| HOA0708-001, -011                    |               | 30  |     |     |               |   |
| HOA0709-001, -011                    |               | 15  |     |     |               |   |
| Emitter-Collector Breakdown Voltage  | $V_{(BR)ECO}$ | 5.0 |     |     | V             | $I_E=100\ \mu\text{A}$  |
| Collector Dark Current               | $I_{CEO}$     |     |     |     | nA            | $V_{CE}=10\text{ V}$<br>$I_F=0$   |
| HOA0708-001, -011                    |               |     |     | 100 |               |   |
| HOA0709-001, -011                    |               |     |     | 250 |               |   |
| <b>COUPLED CHARACTERISTICS</b>       |               |     |     |     |               |   |
| On-State Collector Current           | $I_{C(ON)}$   |     |     |     |               | $V_{CE}=5\text{ V}$<br>$I_F=40\text{ mA}$<br>(1)                                |
| HOA0708-001, -011                    |               | 0.2 |     |     |               |   |
| HOA0709-001, -011                    |               | 1.0 |     |     |               |   |
| Collector-Emitter Saturation Voltage | $V_{CE(SAT)}$ |     |     |     | V             | $I_F=40\text{ mA}$ (1)<br>$I_C=30\ \mu\text{A}$<br>$I_C=125\ \mu\text{A}$       |
| HOA0708-001, -011                    |               |     |     | 0.4 |               |   |
| HOA0709-001, -011                    |               |     |     | 1.1 |               |   |
| Rise And Fall Time                   | $t_r, t_f$    |     |     |     | $\mu\text{s}$ | $V_{CC}=5\text{ V}, I_C=1\text{ mA}$<br>$R_L=1000\ \Omega$<br>$R_L=100\ \Omega$ |
| HOA0708-001, -011                    |               |     |     | 15  |               |   |
| HOA0709-001, -011                    |               |     |     | 75  |               |   |

#### Notes

1. Test surface is Eastman Kodak neutral white test card with 90% diffuse reflectance located 0.15 in. (3.80 mm) from the front surface of the device.

### ABSOLUTE MAXIMUM RATINGS

Operating Temperature Range -40°C to 85°C  
 Storage Temperature Range -40°C to 85°C  
 Soldering Temperature (5 sec) 240°C

#### IR EMITTER

Power Dissipation 70 mW (1)  
 Reverse Voltage 3 V  
 Continuous Forward Current 50 mA

#### DETECTOR

|                           |               |                   |
|---------------------------|---------------|-------------------|
|                           | <b>TRANS.</b> | <b>DARLINGTON</b> |
| Collector-Emitter Voltage | 30 V          | 15 V              |
| Emitter-Collector Voltage | 5 V           | 5 V               |
| Power Dissipation         | 70 mW (1)     | 70 mW (1)         |
| Collector DC Current      | 30 mA         | 30 mA             |

### SCHEMATIC

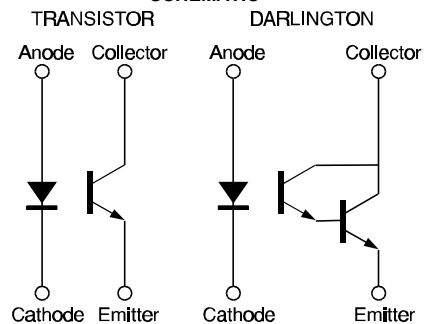

Honeywell reserves the right to make changes in order to improve design and supply the best products possible.

# Honeywell

# HOA0708/0709

## Reflective Sensor

Fig. 1 IRED Forward Bias Characteristics

gra\_073.ds4

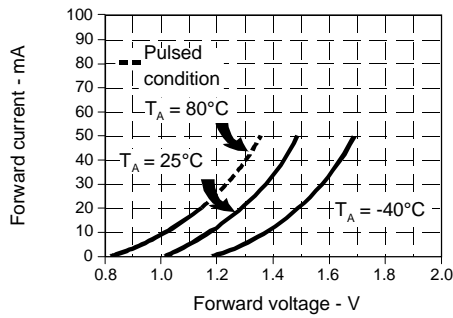

Fig. 2 Non-Saturated Switching Time vs Load Resistance

gra\_079.ds4

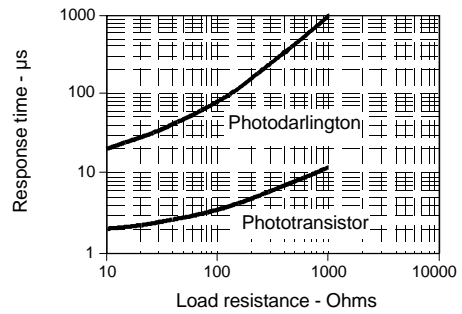

Fig. 3 Dark Current vs Temperature

gra\_301.cdr



Fig. 4 Collector Current vs Ambient Temperature

gra\_076.ds4



Fig. 5 Collector Current vs Distance to Reflective Surface

gra\_080.ds4

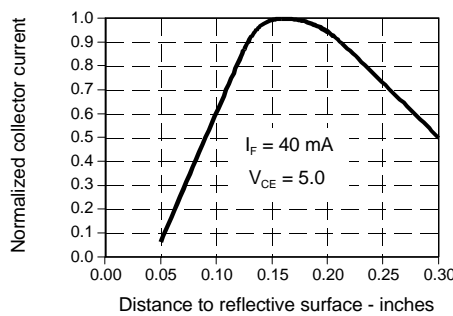
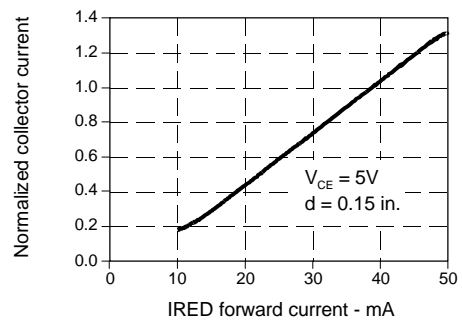

Fig. 6 Collector Current vs IRED Forward Current

gra\_081.ds4



All Performance Curves Show Typical Values

**HOA0708/0709**  
Reflective Sensor

---



Honeywell reserves the right to make changes in order to improve design and supply the best products possible.

**Honeywell**