

ICP-S Technical Manual

ICP-S

1. Overview

The ICP-S is an IC protector of surface mounting type developed as an element for the protection of ICs from output short-circuiting damage. The internal resistance of this lightweight, compact overcurrent protection element is low, as long as the steady-state current of the element does not exceed the rated DC or AC current. The ICP-S, however, turns off ICs instantly if the steady-state current reaches or exceeds the breaking current of the ICP-S.

2. External Dimensions (Unit: mm)

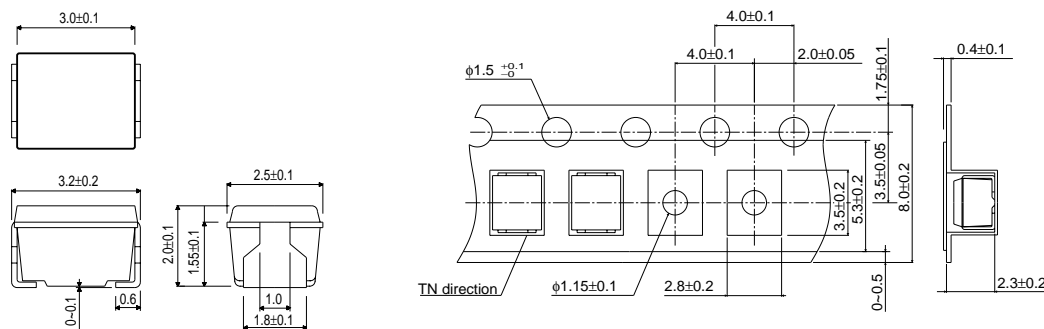

(Mark: TN)

3. Features

- 1) Instantly breaks currents with a low potential drop. (See 3-1 Potential Drop Comparison)
- 2) Compact surface-mounting model. (See 2. External Dimensions)
- 3) Unlike fuses, there is no steady-state current reduction with the rated current applied. No derating is necessary.
- 4) Minimal breaking point dispersion. (See the graph in 3-2 Breaking Current Dispersion Characteristics)
- 5) Excellent temperature characteristics (See the graphs in 3-3 Temperature Characteristics)
 - The fluctuation of the breaking current caused by temperature changes is minimal.
 - Wide operating temperature range: -55°C to $+125^{\circ}\text{C}$
- 6) Excellent vibration resistance.
- 7) UL-approved product with certification No. 107856.
- 8) No deterioration or circuit breaking caused by static electricity.

Overcurrent Protection Elements

3-1 Potential Drop Comparison (ICP-S VS Fuse)

ICP-S1.0 (Rated Current: 1 A)

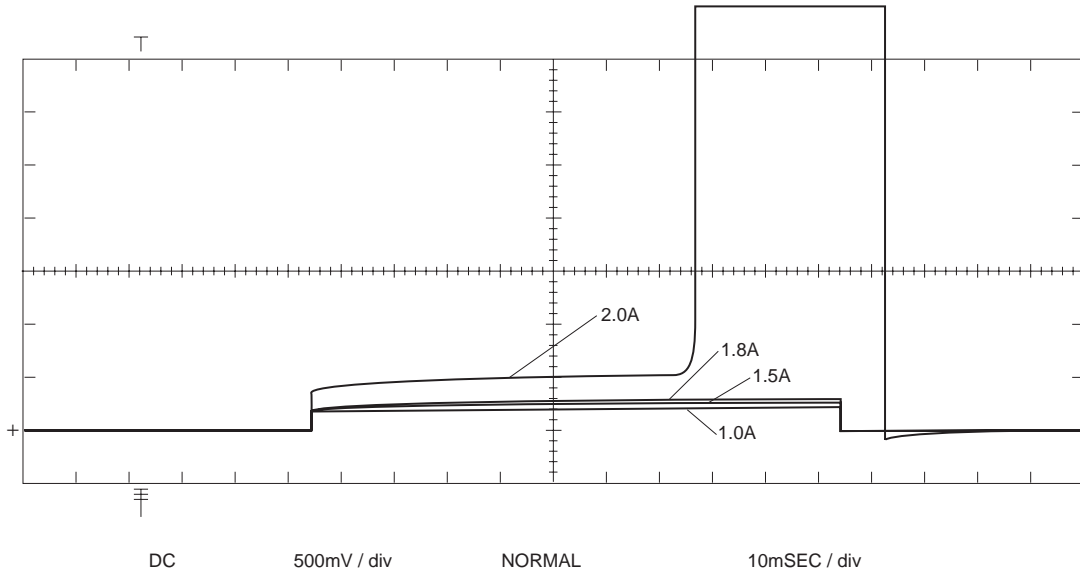

Fuse (Rated Current: 1 A)

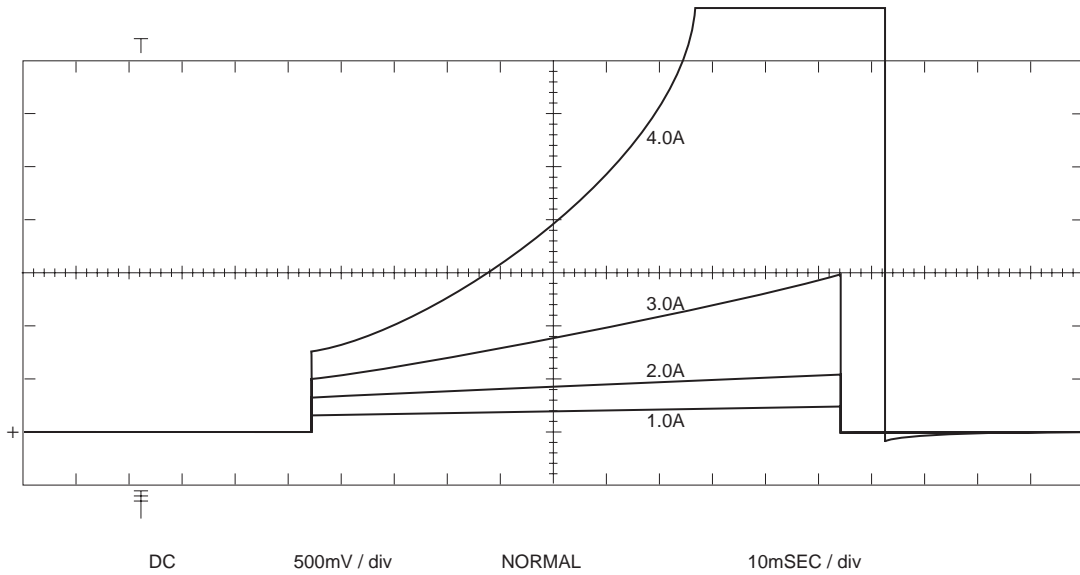

Overcurrent Protection Elements

3-2 Breaking Current Dispersion Characteristics

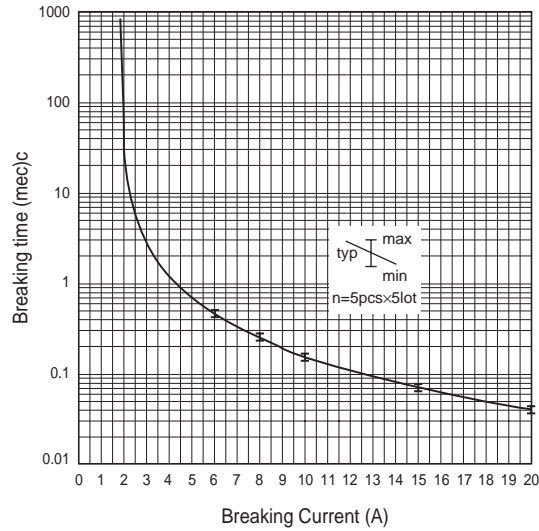

Breaking Time (Reference) Effective Value and Dispersion Data (ICP-S1.0)

3-3 Temperature Characteristics

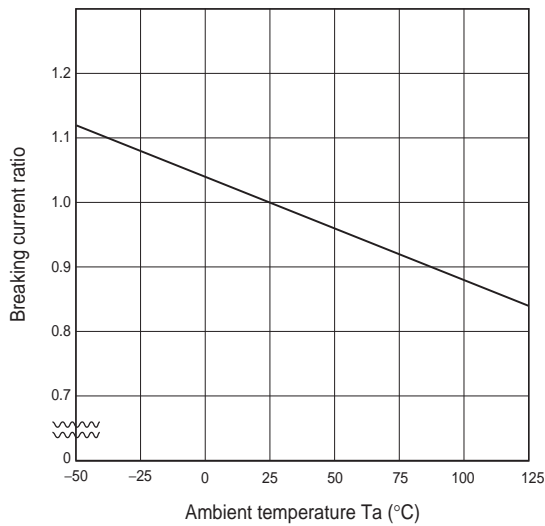

Breaking Current vs. Ambient Temperature Characteristics (ICP-S)

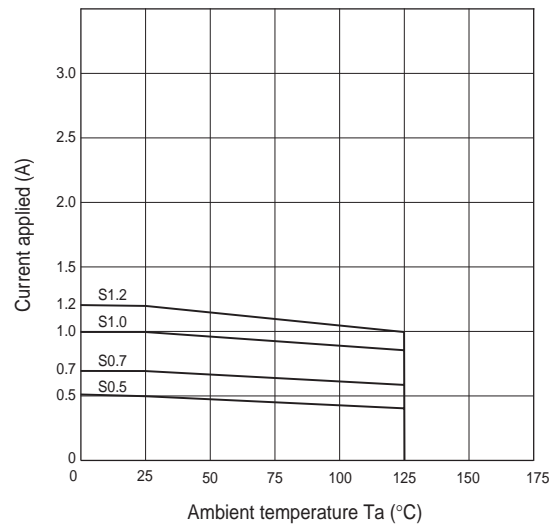

Rated Current Derating Curve (ICP-S)

4. Selection Flowchart

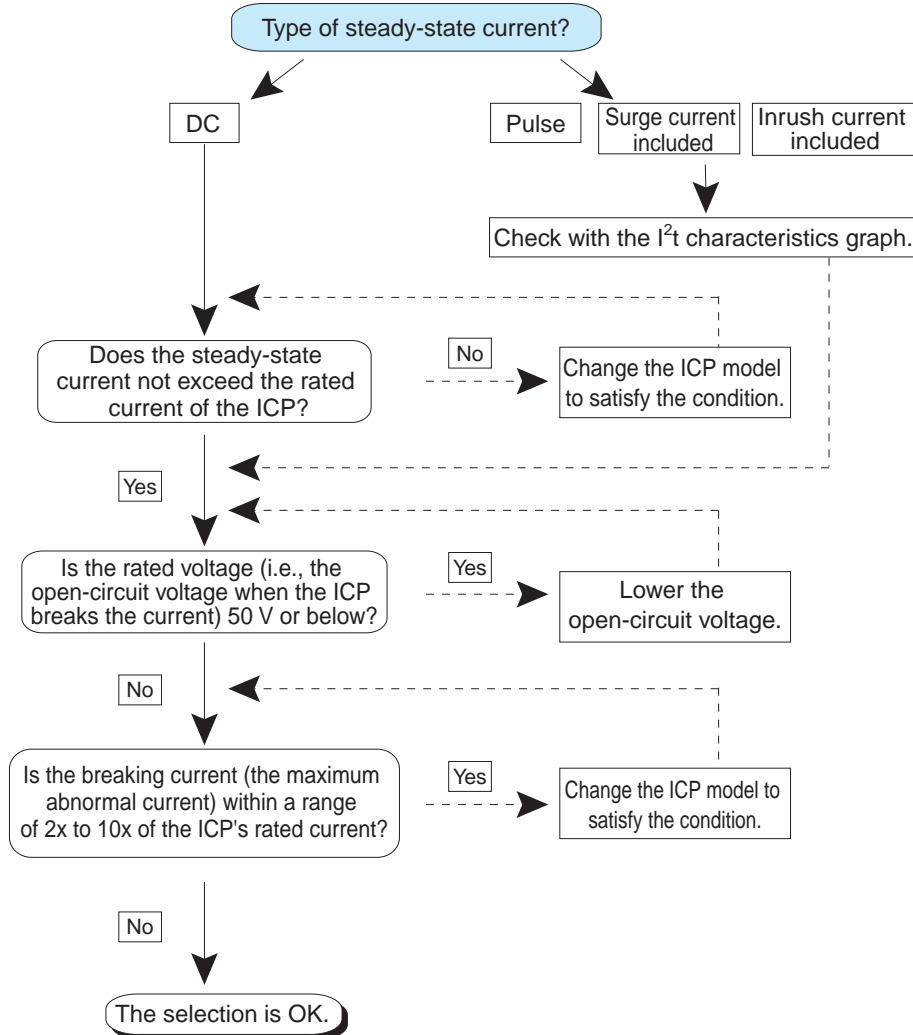

List of ICP-S Models

TYPE	Rated current (A)	Breaking current (A)
ICP-S0.5	0.5	1.0 to 5.0
ICP-S0.7	0.7	1.4 to 7.0
ICP-S1.0	1.0	2.0 to 10.0
ICP-S1.2	1.2	2.4 to 12.0

The I^2t -t characteristic graph (i.e., the Joule integral sheet) provides necessary data used to check how the life of the ICP-S is influenced by heat cycling or mechanical fatigue caused by repetitive current pulses.

5. Checks with I^2t -t Characteristic Graph

If the steady-state current includes a pulse, surge, or inrush-current, use the I^2t graph and check that the ICP will not deteriorate regardless of the mode of the current or the ICP will not break the steady-state current while the ICP is in operation.

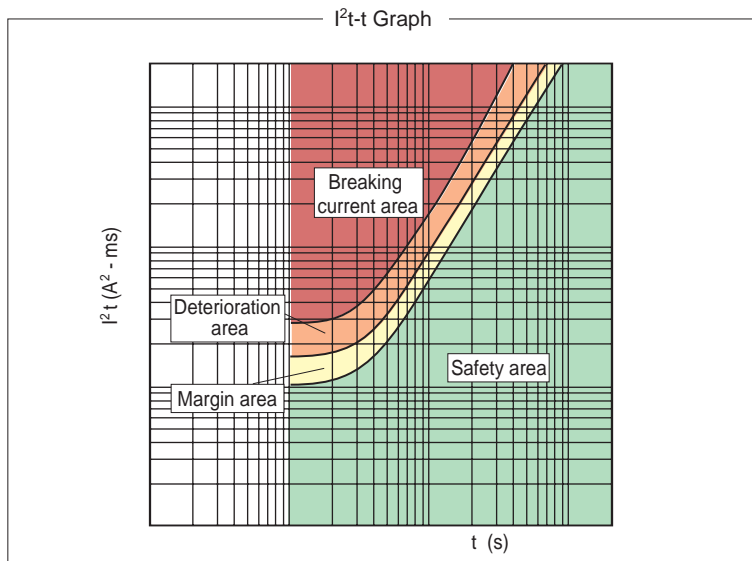
 I^2t Graph

Breaking current area: The ICP breaks the current in this area.

Deterioration area: Although the ICP does not break the current instantaneously, the ICP may break the current as a result of ICP deterioration.

Marginal area: The area where the risk of ICP deterioration is low. Basically avoid using this area.

Safety area: The ICP will not deteriorate or break the current.

Precautions

- Even though the Joule integral value of the current wave form designed at your end is within the safety area, it is recommended that you confirm the steady-state current for the safety of the components

Refer to the next section, calculate the I^2t value, and check the position of the I^2t value in the graph. If the value is in the safety area, it is okay to use the selected ICP model. If the value is, however, beyond the safety area, use an ICP model with higher ratings.

- **Note:** The inspection and selection of the ICP according to the Joule integral value is absolutely based on the results of the approximation of the current wave form. Be sure to inspect all the current wave forms of your application, or otherwise the safety of the application will not be fully ensured.
- Consider a safety margin with the dispersion of component characteristics taken into calculation when inspecting and selecting the ICP, if it is impossible to check the worst current wave form.

Overcurrent Protection Elements

6. I²t Calculation of a Variety of Wave forms

If the steady-state current includes a pulse, surge, or inrush current, calculate the I²t of the wave form of the current. The following graphs and formulas show how to calculate a variety of wave forms.

1) Triangular wave form

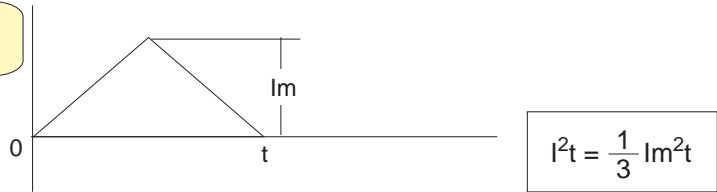

2) Rectangular wave form

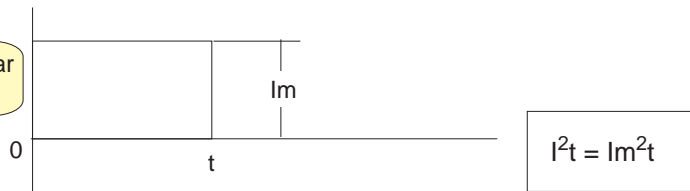

3) Irregular wave form

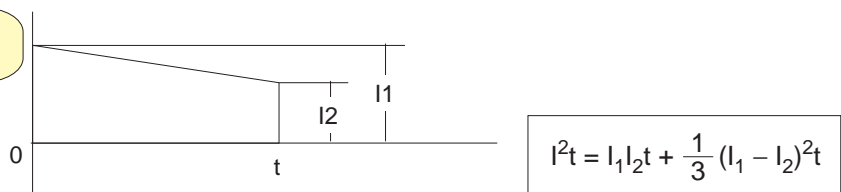

4) Charged or discharged wave form

- The charged wave form is segmented as shown below. The Joule heat generated during each segmented period is plotted onto a Joule integral sheet.

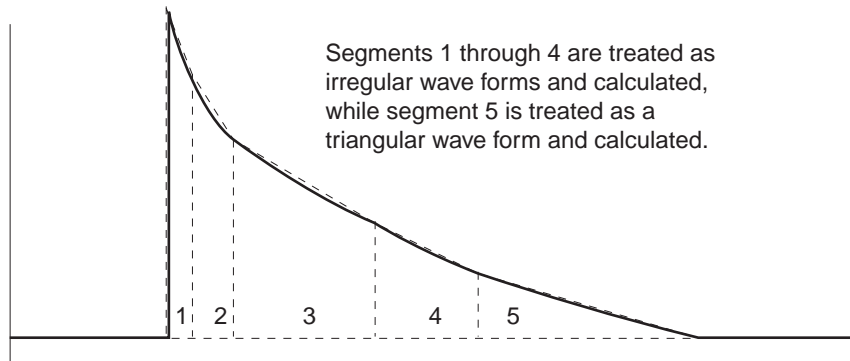

Overcurrent Protection Elements

7. ICP-S Test Example

7-1 Example 1

Current mode: DC

Model: ICP-S1.0

Wave form:

DC	1A
	2A
	5A

Test:

The current values of all segmented periods are plotted respectively as shown in attached graph 1.

1 A: The steady-state current is in the safety area where the ICP-S will not deteriorate or break the current.

2 A: The ICP-S will break the steady-state current in the breaking current area in approximately 100 ms.

5 A: The ICP-S will break the steady-state current in the breaking current area in approximately 0.7 ms.

7-2 Example 2

Current mode: A single pulse

Model: ICP-S1.0

Wave form: A current of 1.75 A flows for a period of 20 ms.

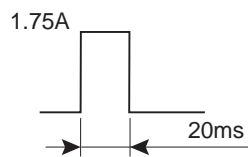

Results: The steady-state current is in the critical area. If the single pulse is repeated intermittently, the ICP-S will deteriorate or break the current in the end.

Test:

$$\begin{aligned} \text{With pulse current: } I^2t &= 1.75^2 \times 20 \\ &= 61 \text{ (A}^2 \cdot \text{ms)} \quad \text{at 20ms} \quad \text{(See graph 2)} \end{aligned}$$

Overcurrent Protection Elements

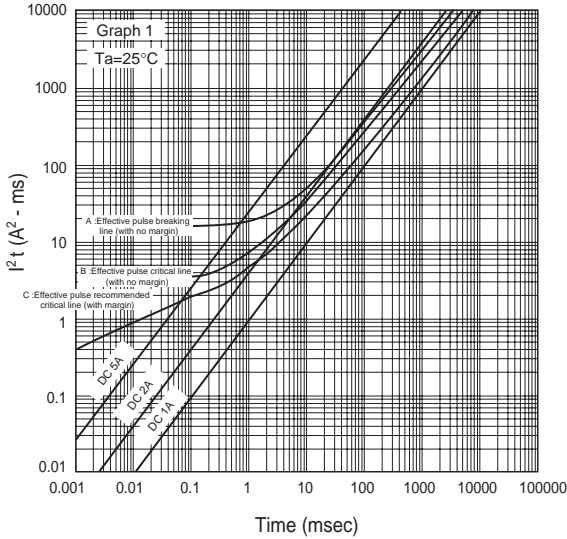

I²t-t Characteristic Curve (ICP-S1.0)

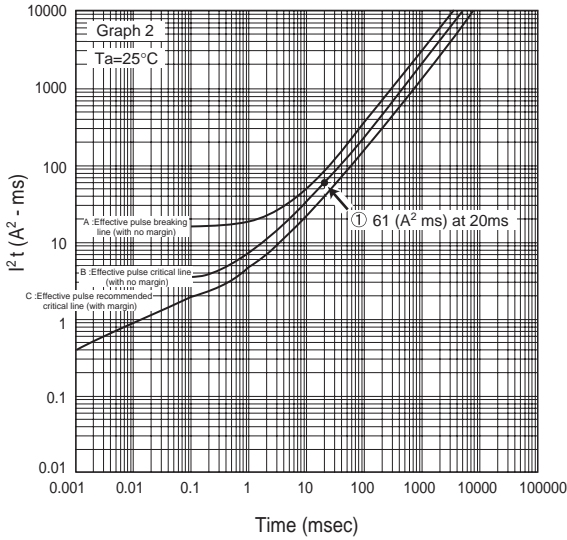

I²t-t Characteristic Curve (ICP-S1.0)

Overcurrent Protection Elements

Joule Integral Calculation of Irregularly Increasing or Decreasing Current

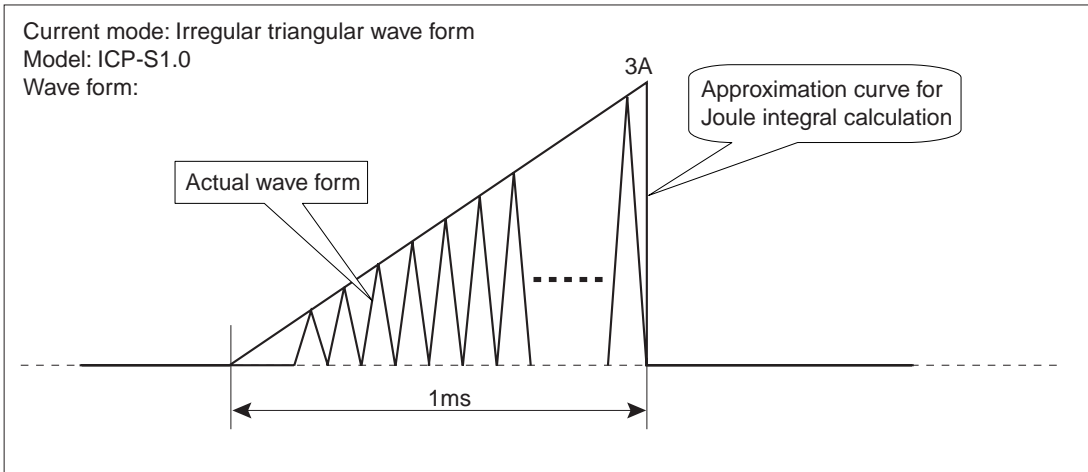

Wave form approximation: The above wave form is approximated by electrically calculating the Joule integral of each segment of the current wave form. In consideration of the heat cycling and mechanical fatigue of the ICP-S, however, a practical Joule integral value is calculated from an approximation curve obtained by connecting the peak of each current wave form.

Test: Obtain the approximated value by substituting the values into the formula (triangular wave form $I^2t = 1/3 \cdot I_m^2 \cdot t$).

$$I^2t = 1/3 \times 3^2A \times 1ms = 3 (A^2 \cdot ms)$$

Plotting test:

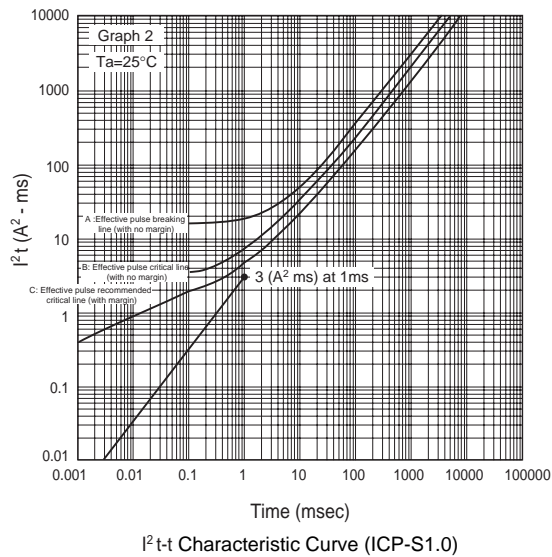

Test results: The steady-state current does not exceed line C. Therefore, it is considered that the ICP-S will not deteriorate or break the current.

Overcurrent Protection Elements

Joule Integral Calculation of Irregularly Increasing or Decreasing Current

Current mode: Irregular wave form + triangular wave form

Model: ICP-S1.2

Wave form:

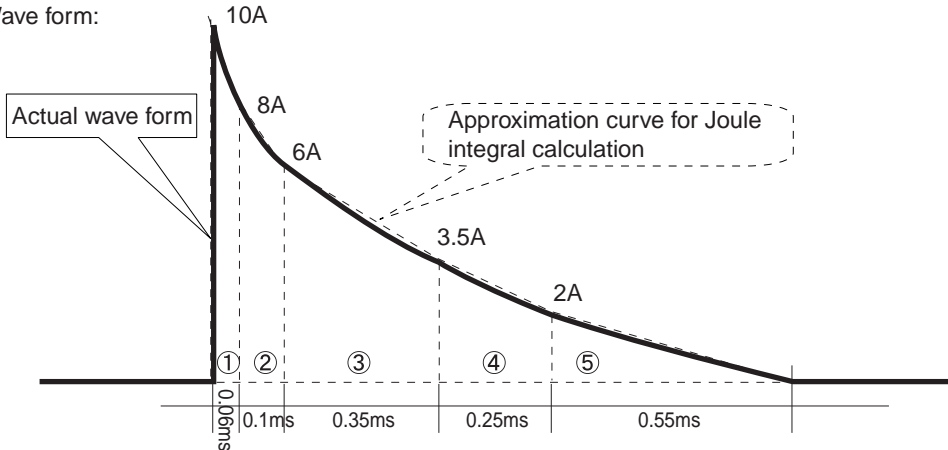

Wave form approximation: The above wave form (electric charge wave form) is approximated as an irregular wave form to calculate the Joule integral of the wave form.

Test:

Item No.	Peak current I _m (A)	Segmented period t (ms)	Joule integral Formula Coefficient × I _m ² × t A ² · ms	Accumulation (A ² · ms)	Lapsed time (ms)
1	10	0.06	10×8×0.06+1/3×(10-8) ² ×0.06=	4.88	0.06
2	8	0.1	8×6×0.1+1/3×(8-6) ² ×0.1=	4.93	0.16
3	6	0.35	6×3.5×0.35+1/3×(6-3.5) ² ×0.35=	8.07	0.51
4	3.5	0.25	3.5×2×0.25+1/3×(3.5-2) ² ×0.25=	1.93	0.76
5	2	0.55	1/3×(2) ² ×0.55=	0.73	1.31

Plotting test:

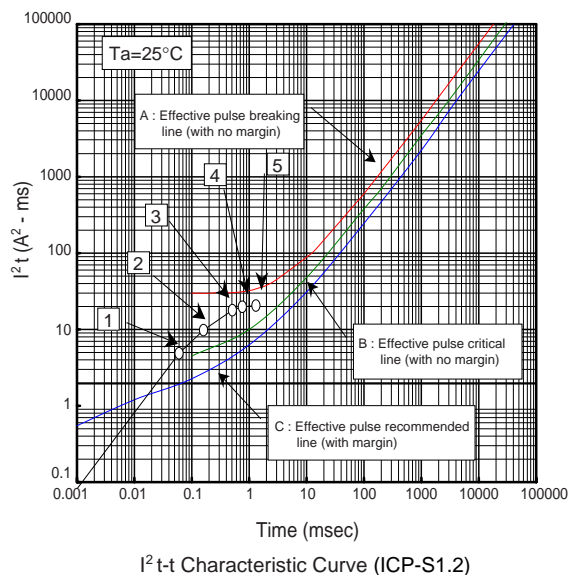

Test results: The steady-state current is between lines B and A. Therefore, it is considered that the ICP-S will deteriorate or break the current due to the repetitive pulses.

Overcurrent Protection Elements

8. Application Circuit Example

8-1 Recommended Flow Soldering Conditions

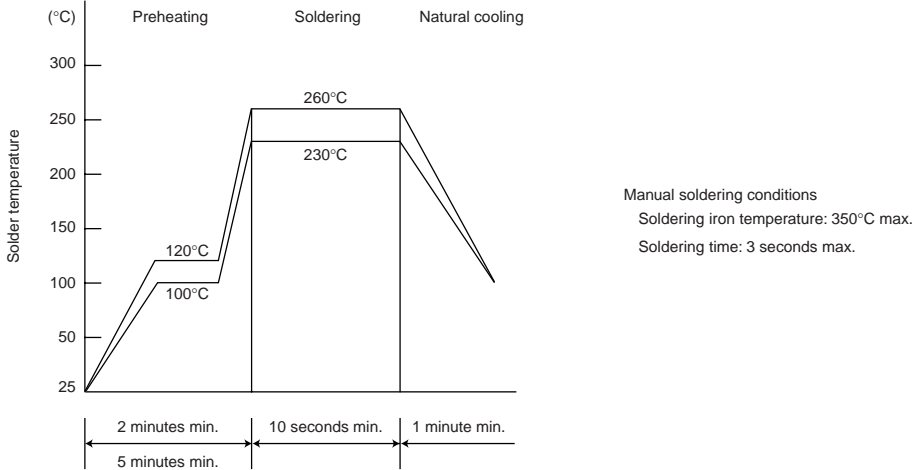

8-2 Recommended Reflow Soldering Conditions

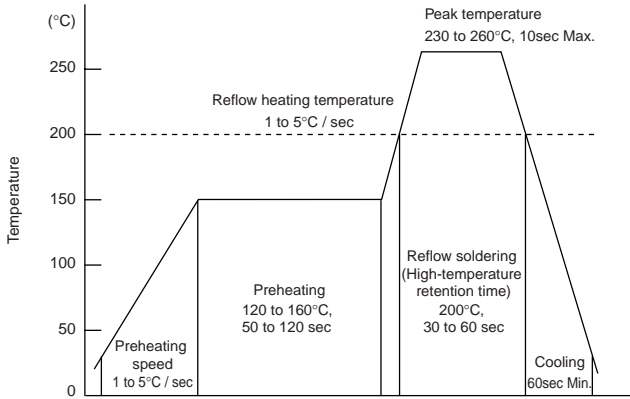

* Number of reflow times: 2 TIMES Max.

A peak temperature of at least 230°C is recommended. If the peak temperature is less than 230°C, it is recommended to make some adjustments, such as the retention of the peak temperature and soldering time longer and an increase in the thickness of solder paste.

8-3 Recommended Copper Pattern on PCB

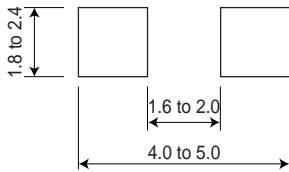

9. Application Circuit Examples

9-1 Power Supply Circuit

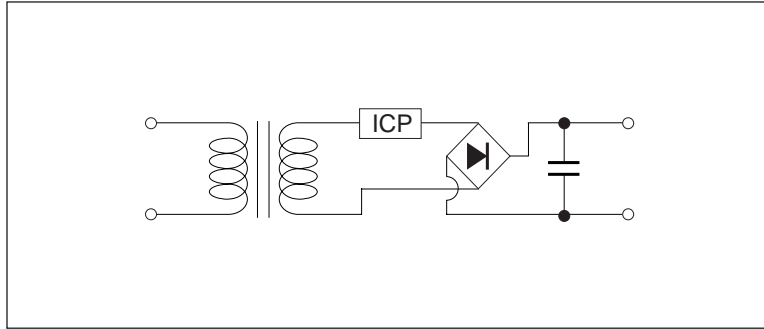

9-2 DC-DC Converter

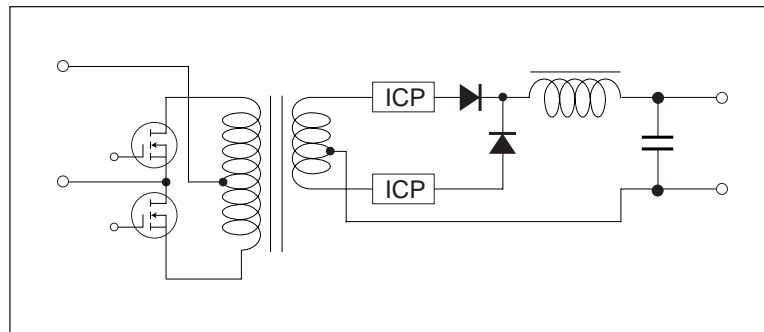

9-3 Motor Control

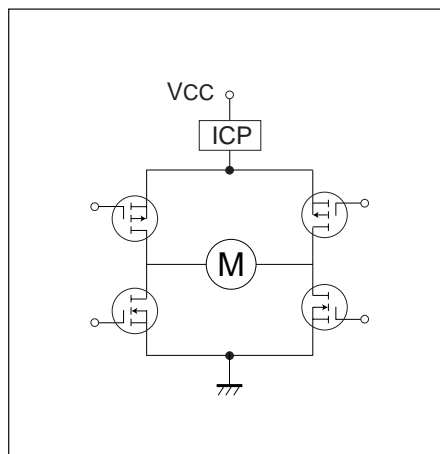

Overcurrent Protection Elements

10. Precautions

1. Set the breaking current two to ten times as high as the rated current.
Use the ICP-S so that the open-circuit voltage between the terminals after the ICP-S breaks the current will be a maximum of 50 V. Unless the ICP-S is used under these conditions, the mold may be damaged or internal resistance may remain after the ICP-S breaks the current.
2. Do not use the ICP-S for the primary side of commercial power supply, or otherwise the mold may be damaged by arcing after the ICP-S breaks the current.

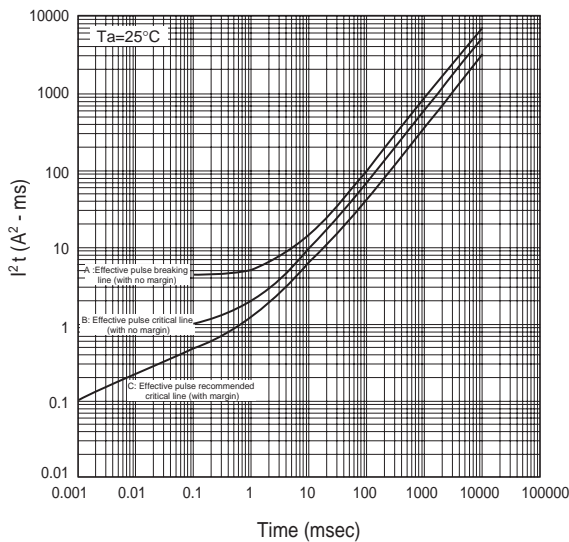

I^2t -t Characteristic Curve (ICP-S0.5)

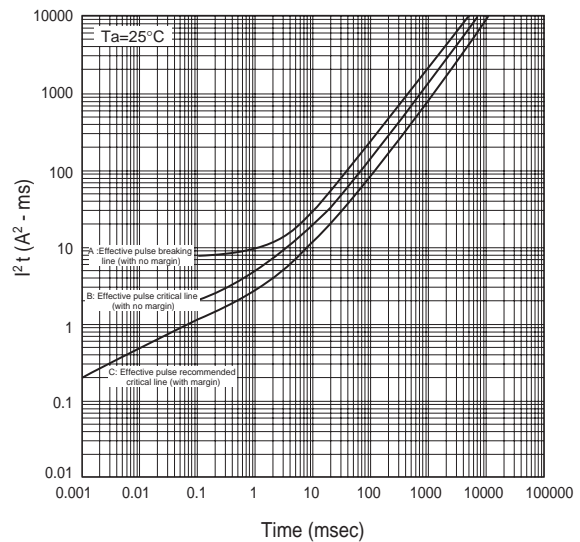

I^2t -t Characteristic Curve (ICP-S0.7)

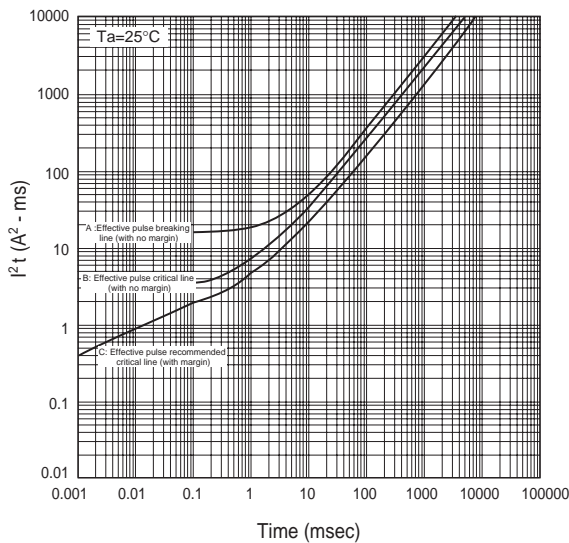

I^2t -t Characteristic Curve (ICP-S1.0)

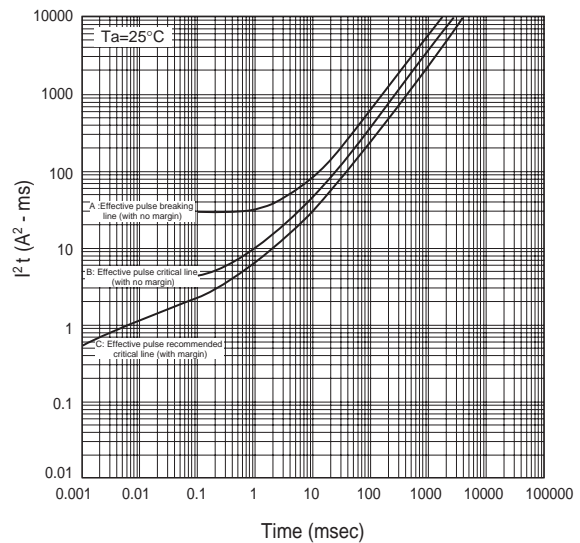

I^2t -t Characteristic Curve (ICP-S1.2)

Notes

- No technical content pages of this document may be reproduced in any form or transmitted by any means without prior permission of ROHM CO.,LTD.
- The contents described herein are subject to change without notice. The specifications for the product described in this document are for reference only. Upon actual use, therefore, please request that specifications to be separately delivered.
- Application circuit diagrams and circuit constants contained herein are shown as examples of standard use and operation. Please pay careful attention to the peripheral conditions when designing circuits and deciding upon circuit constants in the set.
- Any data, including, but not limited to application circuit diagrams information, described herein are intended only as illustrations of such devices and not as the specifications for such devices. ROHM CO.,LTD. disclaims any warranty that any use of such devices shall be free from infringement of any third party's intellectual property rights or other proprietary rights, and further, assumes no liability of whatsoever nature in the event of any such infringement, or arising from or connected with or related to the use of such devices.
- Upon the sale of any such devices, other than for buyer's right to use such devices itself, resell or otherwise dispose of the same, no express or implied right or license to practice or commercially exploit any intellectual property rights or other proprietary rights owned or controlled by
- ROHM CO., LTD. is granted to any such buyer.
- Products listed in this document are no antiradiation design.

The products listed in this document are designed to be used with ordinary electronic equipment or devices (such as audio visual equipment, office-automation equipment, communications devices, electrical appliances and electronic toys).

Should you intend to use these products with equipment or devices which require an extremely high level of reliability and the malfunction of which would directly endanger human life (such as medical instruments, transportation equipment, aerospace machinery, nuclear-reactor controllers, fuel controllers and other safety devices), please be sure to consult with our sales representative in advance.

About Export Control Order in Japan

Products described herein are the objects of controlled goods in Annex 1 (Item 16) of Export Trade Control Order in Japan.

In case of export from Japan, please confirm if it applies to "objective" criteria or an "informed" (by MITI clause) on the basis of "catch all controls for Non-Proliferation of Weapons of Mass Destruction.