

### General Description

The ILC6660 monolithic, charge-pump voltage inverter converts a +1.5V to +5.5V input to a corresponding -1.5V to -5.5V output. Using only two low-cost capacitors, the charge pump's 100mA output replaces switching regulators, eliminating inductors and their associated cost, size, and EMI. Greater than 90% efficiency over most of its load-current range combined with a typical operating current of only 120µA provides ideal performance for both battery-powered and board-level voltage conversion applications. The ILC6660 can also double or split the output voltage of an input powered supply or battery, providing +9.5V or +2.3V at 100mA from a +5V input.

A frequency control (FC) pin selects either 5kHz typ or 50kHz typ (30kHz min) operation to optimize capacitor size and quiescent current. The Oscillator frequency can also be driven with an external clock. The ILC6660 is available in both 8-pin DIP and small-outline packages in commercial and extended temperature ranges.

### Features

- 0.5V Typ Loss at 100mA Load
- Low 120µA Operating Current
- 5.0Ω Typ Output Impedance
- Guaranteed  $R_{OUT} < 10\Omega$  for  $C1 = C2 = 100\mu F$
- Inverts, Doubles or Splits Input Supply Voltage
- Selectable Oscillator Frequency: 5kHz/50kHz
- 90% Typ Conversion Efficiency at 100mA  $I_{OUT}$
- 8-pin SOIC package.

### Applications

- Laptop Computers
- Medical Instruments
- Interface Power Supplies
- Hand-Held Instruments
- Operational-Amplifier Power Supplies

### Typical Circuits

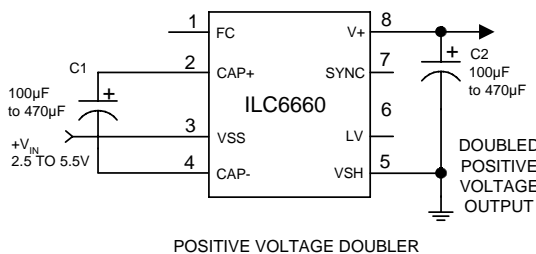
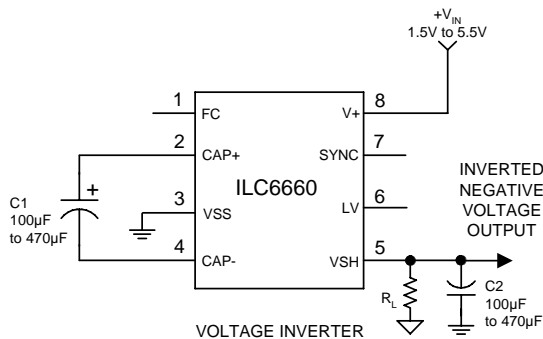

Ordering Information* $T_A = 40^\circ C$ to $85^\circ C$	
ILC6660IK	8-pin SOIC

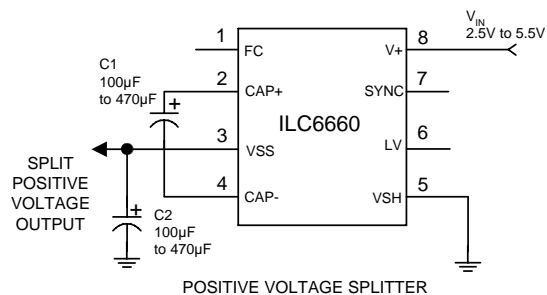

## Pin-Package Configurations

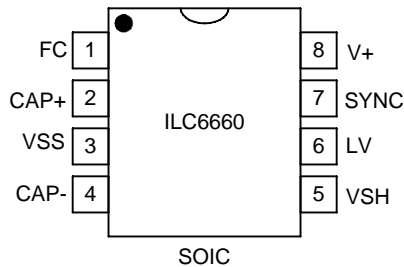

## Pin Functions ILC6660

Pin Number	Pin Name	Inverter	Splitter	Doubler
1	FC	Frequency Control for Internal Oscillator, FC open, $f_{osc} = 5\text{kHz typ}$ ; FC = V+, $f_{osc} = 50\text{kHz typ}$ . FC has no effect when SYNC pin is driven externally.	Same as Inverter	Same as Inverter
2	CAP+	Charge-Pump Capacitor, Positive Terminal	Same as Inverter	Same as Inverter
3	VSS	Power-Supply Ground Input	Power-Supply Positive Voltage Output	Power-Supply Positive Voltage Input
4	CAP-	Charge-Pump Capacitor, Negative Terminal	Same as Inverter	Same as Inverter
5	VSH	Output, Negative Voltage	Power-Supply Ground Input	Power-Supply Ground Input
6	LV	Low-Voltage Operation Input. Tie LV to VSS when input voltage is less than 2V. Above 2V, LV must be left open.	LV must be left open for all input voltages	LV must be left open for all input voltages.
7	SYNC	Oscillator Control Input. SYNC is connected to an internal 15pF capacitor. An external Oscillator may be connected to overdrive SYNC via a 2...5nF capacitor. SYNC shall not be connected to ground.	Same as inverter, however, do not use SYNC in voltage-splitting mode	Same as inverter, however, do not use SYNC in voltage-doubling mode.
8	V+	Power-Supply Positive Voltage Input	Positive Voltage Input	Positive Voltage Output

## Absolute Maximum Ratings (Note 1)

Parameter	Symbol	Ratings	Units
Supply Voltage (V+ to VSS, or VSS to VSH)	$V_{IN}$	+6	V
LV, FC and OSC Input Voltage	$V_{IN}$	VSH -0.3 to V+ +0.3	V
VSH and V+ Continues Output Current	$I_{VSH}$	120	mA
Output Short-Circuit Durations to GND (Note 2)	$I_{SC}$	Not internally protected	A
Continuous Power Dissipation (T = +85C)	$P_D$	470	mW
Operation Temperature Ranges	$T_A$	-40 to +85	°C
Maximum Junction Temperature	$T_{J(max)}$	150	°C
Storage Temperature Range	$T_{stg}$	-40 to +125	°C
Lead Temperature (soldering, 10sec)		300	°C
Package Thermal Resistance	$\theta_{JA}$	138	°C/W

**Note 1.** Absolute maximum ratings indicate limits which, when exceeded, may result in damage to the component. Electrical specifications do not apply when operating the device outside its rated operating conditions.

**Note 2.** VSH must not be shorted to VSS or V+, even instantaneously, or device damage may result.

## Electrical Characteristics ILC6660IK

Unless otherwise specified, all limits are at  $T_A = 25^\circ\text{C}$ ;  $V_+ = 5\text{V}$ ,  $C_1 = C_2 = 100\mu\text{F}$ , test circuit of Figure 1, FC = open.

**Boldface** limits apply over the operating temperature range. (Note 3)

Parameter	Symbol	Conditions	Min	Typ	Max	Units
Operating Supply Voltage	$V_{IN}$	$R_L = 1\text{k}\Omega$ , LV open	3.0		5.5	V
		$R_L = 1\text{k}\Omega$ , LV = VSS	1.5		2	V
		$R_L = 1\text{k}\Omega$ , LV open Doubler or Splitter	2		5.5	
Supply Current	$I_{IN}$	VSH = open, FC + open, LV = open		120	300	$\mu\text{A}$
		VSH = open, FC = V+, LV = open		1	2	mA
Output Current	$I_{VSH}$	VSH more negative than -4V	100			mA
Output Resistance (Note 4)	$R_{VSH}$	$I_L = 100\text{mA}$		5.0	10	$\Omega$
Oscillator Frequency	$f_{OSC}$	<b>FC = open</b>	<b>2.5</b>	<b>5.0</b>	<b>10.0</b>	<b>kHZ</b>
		<b>FC = V+</b>	<b>30</b>	<b>50</b>	<b>90.0</b>	<b>kHZ</b>
Power Efficiency	$\eta$	$R_L = 1\text{k}\Omega$ , connected between V+ and VSH	96	98		%
		$R_L = 500\Omega$ , between VSH and VSS	92	96		%
		$I_L = 100\text{mA}$		90		%
Voltage-Conversion Efficiency		No load	99.00	99.96		%

**Note 3.** Specified min/max limits are production tested or guaranteed through correlation based on statistical control methods.

**Note 4.** Specified output resistance is a combination of internal switch resistance and capacitor ESR.

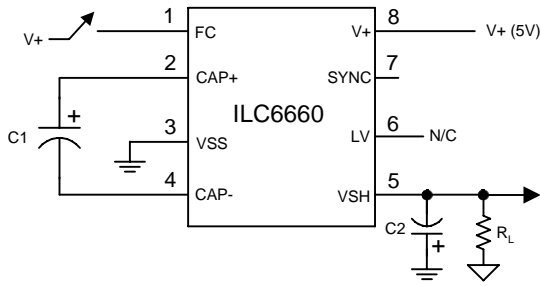

Figure 1: Test Circuit

**Detailed Description**

The ILC6660 capacitive charge-pump circuit either inverts, splits or doubles the input voltage (see Typical Circuits). For highest performance, low effective series resistance (ESR) capacitors should be used (see Capacitor Selection section for more details). When using the inverting mode with a supply voltage less than 2V, LV may be connected to VSS. This bypasses the internal regulator circuitry and provides best performance in low-voltage applications. When using the inverter mode with a supply voltage above 2V, LV must be left open.

**Applications Information**

**Negative Voltage Converter**

The most common application of the ILC6660 is as a charge-pump voltage inverter. The operating circuit uses only two external capacitors, C1 and C2 (see Typical Circuits). Even though its output is not actively regulated, the ILC6660 is very insensitive to load current changes. A typical output source resistance of 5Ω means that with an input of +5V the output voltage is -5V under light load, and decreases only to 4.5V with a load of 100mA.

**Capacitors selection**

Low ESR capacitors should be used at the output of ILC6660 to minimize output ripple. This can be achieved using ceramic capacitors, but may also be met with certain types of tantalum capacitors.

Output ripple voltage is calculated taking into account that the output current is solely supplied from capacitor C2 during one-half of the charge-pump cycle. This introduces a peak-to-peak ripple of:

$$V_{RIPPLE} = \frac{I_{VSH}}{2(f_{PUMP})(C2)} + I_{VSH} (ESRC2)$$

For a nominal fPUMP of 5kHz and C2 = 100μF with an ESR of 0.05Ω, ripple is approximately 100mV with a 100mA load current. If C2 is raised to 470μF, the ripple drops to approximately 25mV.

**Positive Voltage Doubler**

The ILC6660 operates in the voltage-doubling mode as shown in the Typical Circuit. The no-load output is 2 x VIN.

**Positive Voltage Splitter**

The ILC6660 operates in voltage splitting mode as shown in the Typical Circuit. The no-load output is VIN/2

**Changing Oscillator Frequency**

Three modes control the ILC6660's clock frequency, as listed below:

FC	SYNC	Oscillator Frequency
Open	Open	5kHz
FC = V+	Open	50kHz
Open	External Clock	External Clock Frequency

When FC and SYNC are unconnected (open), the Oscillator runs at 5kHz typically. When FC is connected to V+, the charge and discharge current change from 1.0μA to 10.0μA, thus increasing the Oscillator frequency 10 times. In the inverter mode, SYNC may also be overdriven by an external clock source. A square wave signal of maximum 2V peak-to-peak may be applied to SYNC via a 2...5nF capacitor to overdrive the internal oscillator. When SYNC is overdriven, FC has no effect. In some applications, the 5kHz output ripple frequency may be low enough to interfere with other circuitry. If desired, the Oscillator frequency can then be increased through use of the FC pin or an external Oscillator as described above. Increasing the clock frequency increases the ILC6660's quiescent current, but also allows smaller capacitance values to be used for C1 and C2.

Packaging Information

M Package, 8-Pin Small-Outline

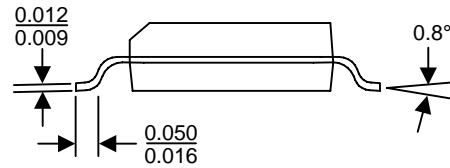
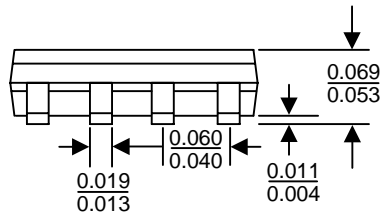
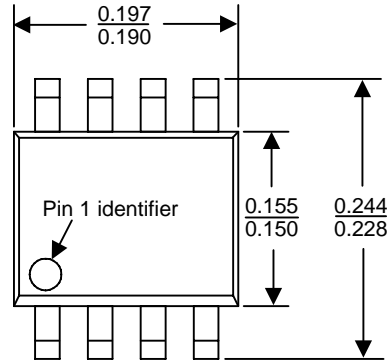

N Package, 8-Pin Dual In-Line

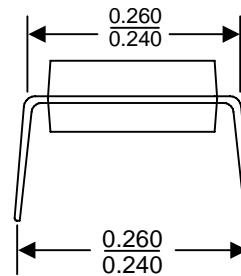
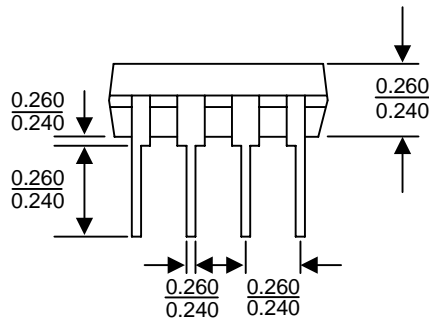
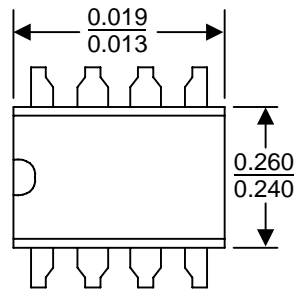

Devices sold by Impala Linear Corporation are covered by the warranty and patent indemnification provisions appearing in its Terms of Sale only. Impala Linear Corporation makes no warranty, express, statutory, implied, or by description regarding the information set forth herein or regarding the freedom of the described devices from patent infringement. Impala Linear Corporation makes no warranty of merchantability or fitness for any purpose. Impala Linear Corporation reserves the right to discontinue production and change specifications and prices at any time and without notice.

This product is intended for use in normal commercial applications. Applications requiring an extended temperature range, unusual environmental requirements, or high reliability applications, such as military and aerospace, are specifically not recommended without additional processing by Impala Linear Corporation.

Impala Linear Corporation assumes no responsibility for the use of any circuitry other than circuitry embodied in an Impala Linear Corporation product. No other circuits, patents, licenses are implied.

Life Support Policy

Impala Linear Corporation's products are not authorized for use as critical components in life support devices or systems.

1. Life support devices or systems are devices or systems which, (a) are intended for surgical implant into the body, or (b) support or sustain life, and whose failure to perform, when properly used in accordance with instructions for use provided in the labeling, can be reasonably expected to result in a significant injury to the user.

2. A critical component is any component of a life support device or system whose failure to perform can be reasonably expected to cause the failure of the life support device or system, or to affect its safety or effectiveness.