

### General Description

250mA CMOS LDO in a SOT-23 package, featuring 120mV of dropout voltage at 100mA and 380mV at 200mA current levels

The part offers  $\pm 2\%$  accuracy on outputs, yet draws only  $2\mu\text{A}$  of current. Short-circuit protection is standard.

The part comes in both 3-lead SOT-23 (150mW) and 3-lead SOT-89 (500mW) to handle a variety of voltage and current levels.

Transient response to load variations have improved in comparison to the existing series.

Low Power consumption and high accuracy is achieved through CMOS and laser trimming technologies.

### Features

- Low Power Consumption: typ  $2.0\mu\text{A}$  at  $V_{\text{OUT}} = 5\text{V}$
- All-CMOS design in SOT-23 and SOT-89 packages gives optimal size and power performances.
- Highly accurate output  $\pm 2\%$  ( $\pm 1\%$ )
- Maximum output current: 250mA (Limited to 150mW power dissipation SOT-23, 500mW SOT-89)
- Output Voltage Range: 2.0V to 6.0V

### Applications

- Battery-powered Equipment
- Reference voltage sources
- Palmtops
- Portable cameras and video recorders

### Block Diagram

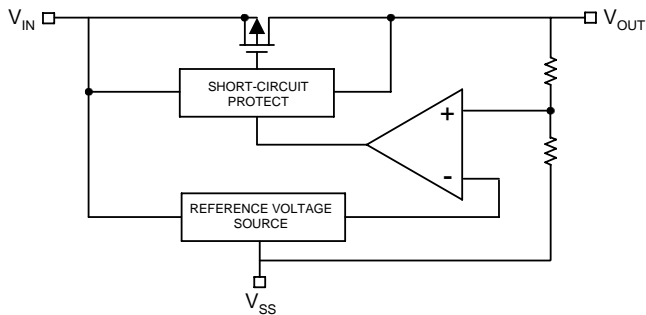

### Ordering Information\*

ILC7062CP-50	5.0V output, SOT-89*
ILC7062CM-50	5.0V output, SOT-23-3**
ILC7062CP-46	4.6V output, SOT-89*
ILC7062CP-33	3.3V output, SOT-89*
ILC7062CP-30	3.0V output, SOT-89*
ILC7062CP-25	2.5V output, SOT-89*
ILC7062CM-25	2.5V output, SOT-23-3**
	* Max power dissipation of 500mW
	** Max power dissipation of 150mW

\*Standard product offering comes in tape & reel, quantity 3000 per reel, orientation right for SOT-23, quantity 1000 per reel, orientation right for SOT-89.

### Pin-Package Configurations

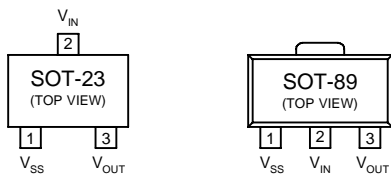

### Standard Circuit

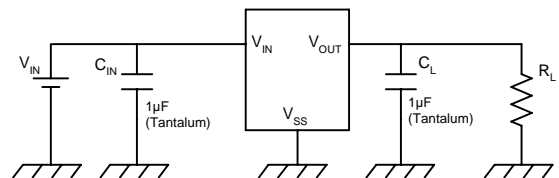

Absolute Maximum Ratings ( $T_A = 25^\circ\text{C}$ )

Parameter	Symbol	Ratings	Units
Input Voltage	$V_{IN}$	12	V
Output Current <b>(Note 3)</b>	$I_{OUT\ MAX}$	500	mA
Output Voltage <b>(Note 1)</b>	$V_{OUT}$	$V_{SS}-0.3\sim V_{IN}+0.3$	V
Continuous Total Power Dissipation	SOT-23	$P_d$	150
	SOT-89		500
Operating Ambient Temperature	$T_{opr}$	-40~+85	$^\circ\text{C}$
Storage Temperature	$T_{stg}$	-40~+125	$^\circ\text{C}$

## Electrical Characteristics ILC7062CP-50

 $T_A = 25^\circ\text{C}$ 

Parameter	Symbol	Conditions	Min	Typ	Max	Units
Output Voltage	$V_{OUT}$	$I_{OUT} = 40\text{mA}$ , $V_{IN} = 6.0\text{V}$	4.90	5.0	5.10	V
Maximum Output Current	$I_{OUT\ max}$	$V_{IN} = 6.0\text{V}$ , $V_{OUT} \geq 4.5\text{V}$	250			mA
Load Stability	$\Delta V_{OUT}$	$V_{IN} = 6.0\text{V}$ , $1\text{mA} \leq I_{OUT} \leq 100\text{mA}$		40	80	mV
Input/Output Voltage Differential <b>(Note 2)</b>	$V_{dif}$	$I_{OUT} = 100\text{mA}$		120	300	mV
		$I_{OUT} = 200\text{mA}$		380	600	
Supply Current	$I_{SS}$	$V_{IN} = 6.0\text{V}$		2	4.5	$\mu\text{A}$
Input Stability	$\frac{\Delta V_{OUT}}{\Delta V_{IN} \cdot V_{OUT}}$	$I_{OUT} = 40\text{mA}$ $6.0\text{V} \leq V_{IN} \leq 10.0\text{V}$		0.2	0.3	%/V
Input Voltage	$V_{IN}$				10.0	V
Output Voltage Temperature Characteristics	$\frac{\Delta V_{OUT}}{\Delta T_{opr} \cdot V_{OUT}}$	$I_{OUT} = 40\text{mA}$ $-40^\circ\text{C} \leq T_{opr} \leq 85^\circ\text{C}$		$\pm 100$		ppm/ $^\circ\text{C}$

Notes:

- $V_{OUT}$  means the output voltage when " $V_{OUT} + 1.0\text{V}$ " is provided at the  $V_{IN}$  pin while maintaining a certain  $I_{OUT}$  value.
- $V_{dif}$  is defined as " $V_{IN} - V_{OUT}$ " where  $V_{OUT} = V_{SET} \times 0.98$ .
- $I_{OUT\ max}$  = This is specified for SOT-89 package. For SOT-23, it is limited by continuous total power dissipation.

## Electrical Characteristics ILC7062CM-33

 $T_A = 25^\circ\text{C}$ 

Parameter	Symbol	Conditions	Min	Typ	Max	Units
Output Voltage	$V_{OUT}$	$I_{OUT} = 40\text{mA}$ , $V_{IN} = 4.3\text{V}$	3.234	3.300	3.366	V
Maximum Output Current	$I_{OUTmax}$	$V_{IN} = 4.3\text{V}$ , $V_{OUT} \geq 2.97\text{V}$	50			mA
Load Stability	$\Delta V_{OUT}$	$V_{IN} = 4.3\text{V}$ , $1\text{mA} \leq I_{OUT} \leq 80\text{mA}$		45	90	mV
Input/Output Voltage Differential (Note 2)	$V_{dif}$	$I_{OUT} = 80\text{mA}$ $I_{OUT} = 160\text{mA}$		180 400	360 700	mV
Supply Current	$I_{SS}$	$V_{IN} = 4.0\text{V}$		2	4.5	$\mu\text{A}$
Input Stability	$\frac{\Delta V_{OUT}}{\Delta V_{IN} \cdot V_{OUT}}$	$I_{OUT} = 40\text{mA}$ $4.3\text{V} \leq V_{IN} \leq 10.0\text{V}$		0.2	0.3	%/V
Input Voltage	$V_{IN}$				10.0	V
Output Voltage Temperature Characteristics	$\frac{\Delta V_{OUT}}{\Delta T_{opr} \cdot V_{OUT}}$	$I_{OUT} = 40\text{mA}$ $-30^\circ\text{C} \leq T_{opr} \leq 80^\circ\text{C}$		$\pm 100$		ppm/ $^\circ\text{C}$

## Electrical Characteristics ILC7062CP-30

 $T_A = 25^\circ\text{C}$ 

Parameter	Symbol	Conditions	Min	Typ	Max	Units
Output Voltage	$V_{OUT}$	$I_{OUT} = 40\text{mA}$ , $V_{IN} = 4.0\text{V}$	2.94	3.0	3.06	V
Maximum Output Current	$I_{OUTmax}$	$V_{IN} = 4.0\text{V}$ , $V_{OUT} \geq 2.7\text{V}$	150			mA
Load Stability	$\Delta V_{OUT}$	$V_{IN} = 4.0\text{V}$ , $1\text{mA} \leq I_{OUT} \leq 80\text{mA}$		45	90	mV
Input/Output Voltage Differential (Note 2)	$V_{dif}$	$I_{OUT} = 80\text{mA}$ $I_{OUT} = 160\text{mA}$		180 400	360 700	mV
Supply Current	$I_{SS}$	$V_{IN} = 4.0\text{V}$		2	4.5	$\mu\text{A}$
Input Stability	$\frac{\Delta V_{OUT}}{\Delta V_{IN} \cdot V_{OUT}}$	$I_{OUT} = 40\text{mA}$ $4.0\text{V} \leq V_{IN} \leq 10.0\text{V}$		0.2	0.3	%/V
Input Voltage	$V_{IN}$				10.0	V
Output Voltage Temperature Characteristics	$\frac{\Delta V_{OUT}}{\Delta T_{opr} \cdot V_{OUT}}$	$I_{OUT} = 40\text{mA}$ $-30^\circ\text{C} \leq T_{opr} \leq 80^\circ\text{C}$		$\pm 100$		ppm/ $^\circ\text{C}$

Notes:

- $V_{OUT}$  means the output voltage when " $V_{OUT} + 1.0\text{V}$ " is provided at the  $V_{IN}$  pin while maintaining a certain  $I_{OUT}$  value.
- $V_{dif}$  is defined as " $V_{IN} - V_{OUT}$ " where  $V_{OUT} = V_{SET} \times 0.98$ .
- $I_{OUTmax}$  = This is specified for SOT-89 package. For SOT-23, it is limited by continuous total power dissipation.

Typical Performance Characteristics *General conditions for all curves*

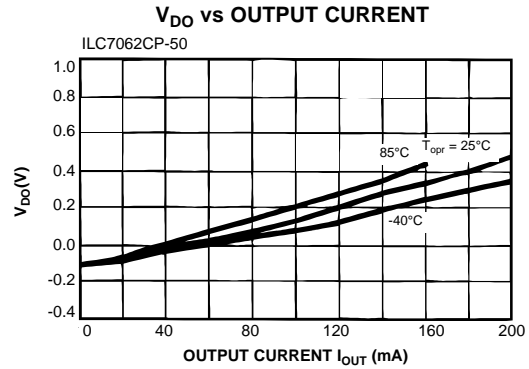
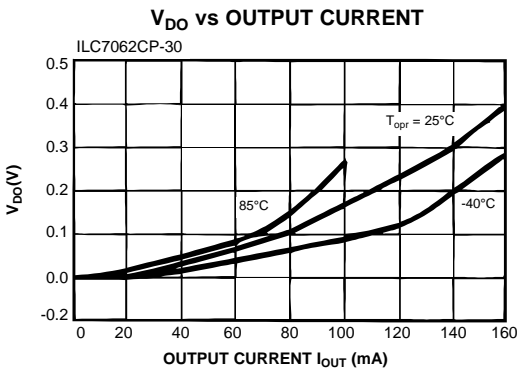
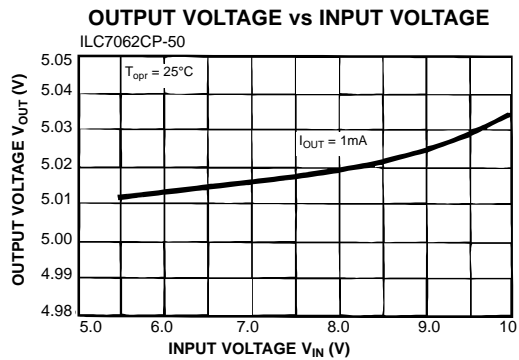
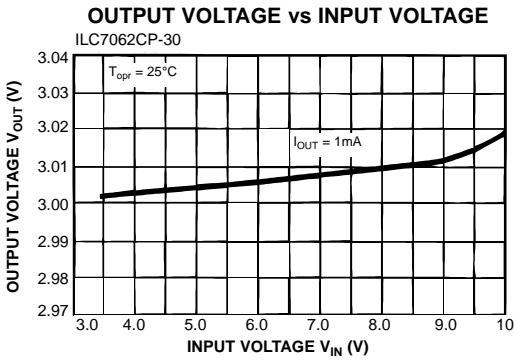
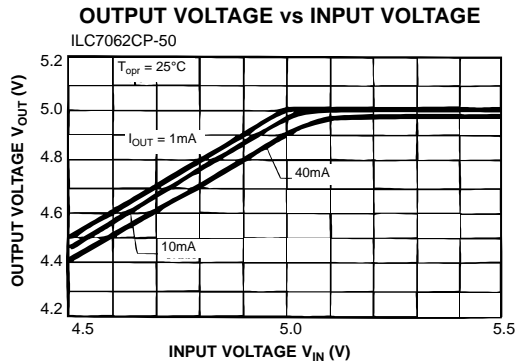
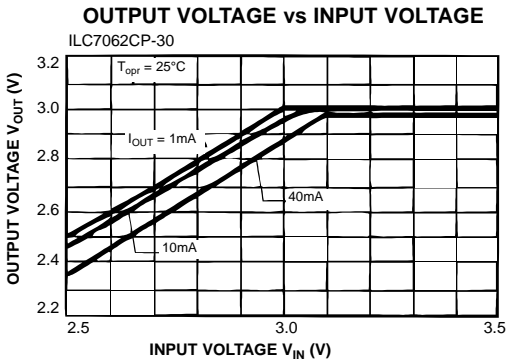
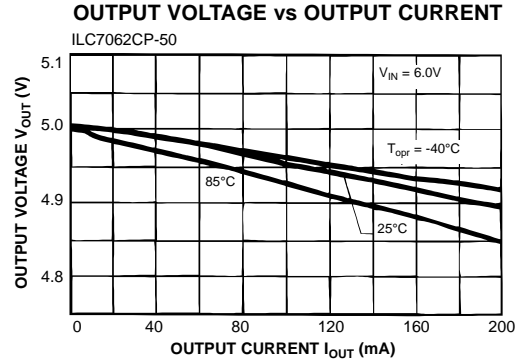
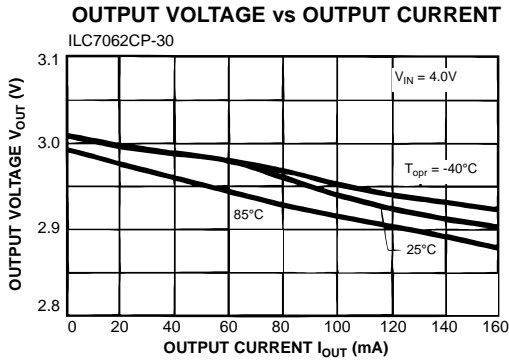

Typical Performance Characteristics *General conditions for all curves*

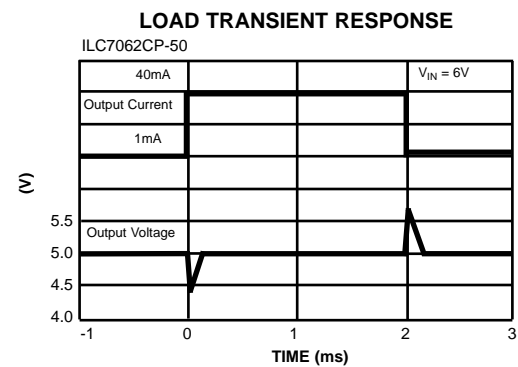
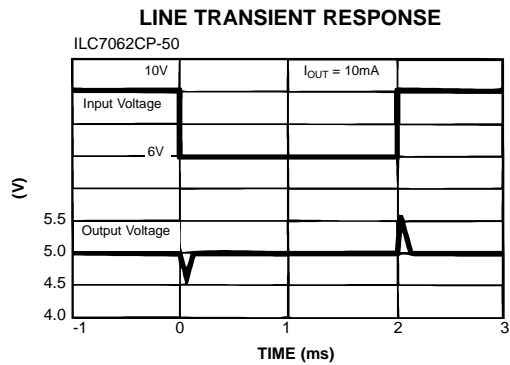
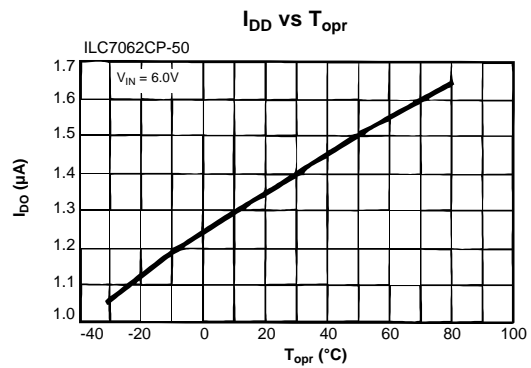
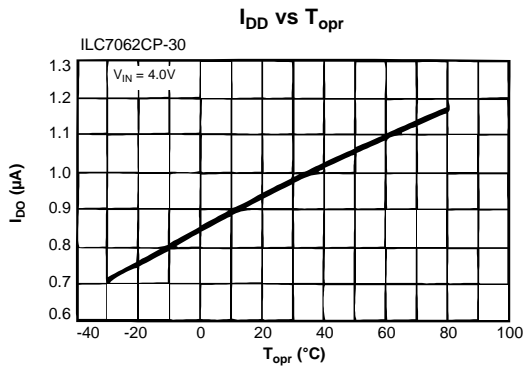
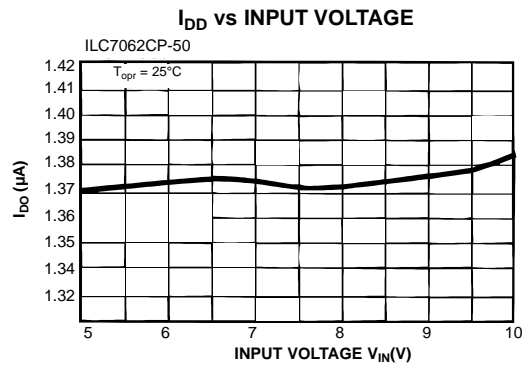
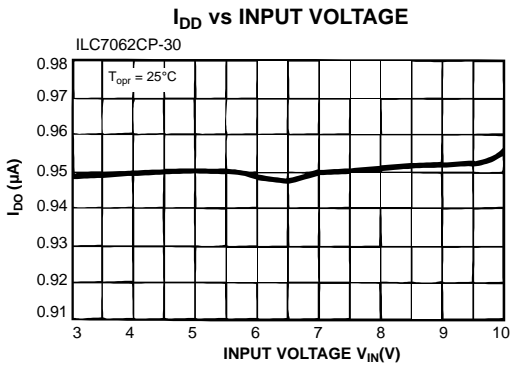
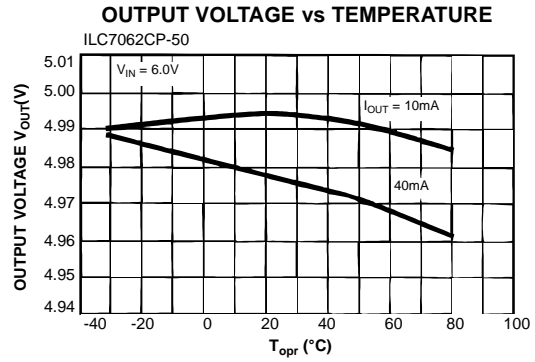
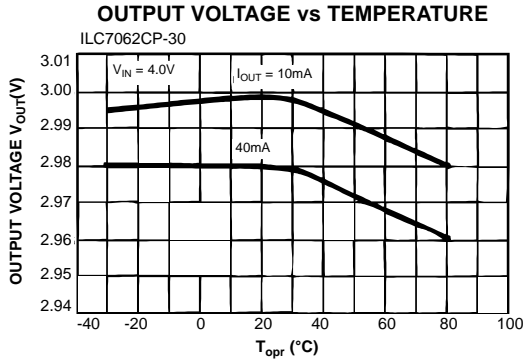

**Typical Performance Characteristics** *General conditions for all curves*

