

## JPS250 Series

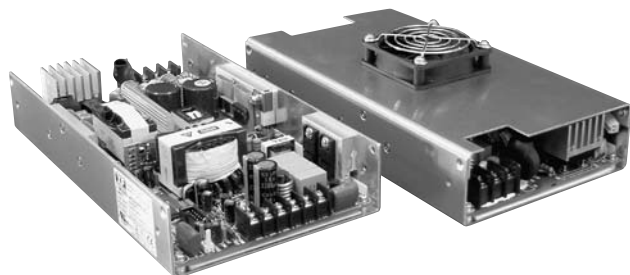

- 200 W with Convection Cooling
- High Efficiency - up to 88%
- Meets 1U, Low Profile Requirements
- AC OK & DC OK Signals
- Zero Voltage Switching Technology
- Remote On/Off & Remote Sense
- Current Share

## Specification

---

### Input

Input Voltage	• 90-264 VAC (170-370 VDC)
Input Frequency	• 47-63 Hz
Input Current	• 2.75 A/1.40 A max at 115 VAC/230 VAC
Inrush Current	• 30 A at 115 VAC, 60 A at 230 VAC
Power Factor	• 0.99 typical
Earth Leakage Current	• 2.0 mA max 264 VAC/60 Hz
Input Protection	• Internal 5 A, 250 V fuse

### Output

Output Voltage	• See tables
Output Voltage Trim	• $\pm 10\%$ on output 1 only
Initial Set Accuracy	• At 60% rated load $\pm 1\%$ on V1 & V2, $\pm 5\%$ on V3 & V4
Minimum Load	• Single output models: No minimum load required. Multi-output models, see note 4
Start Up Delay	• 2 s typical
Start Up Rise Time	• 80 ms typical
Hold Up Time	• 20 ms min at low line & rated load
Line Regulation	• $\pm 0.5\%$ at rated load across input voltage range
Load Regulation	• $\pm 1\%$ for single output models & V1 & V2 of multi-output models, $\pm 5\%$ for V3 & V4
Transient Response	• 4% max deviation, recovery to within 1% in 500 $\mu$ s for a 25% load change
Ripple & Noise	• $\pm 1\%$ max pk-pk, 20 MHz BW
Overvoltage Protection	• 115-140% on single outputs & V1 of quad output models, recycle input to reset
Overtemperature Protection	• Shuts down at $+110$ °C, auto recovery measured internally
Overload Protection	• 110-130% of max rated load on all O/Ps, trip & restart (Hiccup mode), auto recovery
Short Circuit Protection	• Trip and restart (Hiccup mode)
Temperature Coefficient	• $\pm 0.05\%/^{\circ}\text{C}$
Remote Sense	• Compensates for up to 0.5 V drop
Remote On/Off	• On = Logic Low or Open, Off = Logic High
Current Share	• Single wire current sharing on single output models & V1 & V2 of multi-output models (4 supplies can be paralleled)
Fan Output	• 5 V model: 5 V at 390 mA, 24 V model: 24 V at 80 mA, all other models: 12 V at 112 mA

### General

Efficiency	• Up to 88%
Isolation	• 3000 VAC Input to Output 1500 VAC Input to Ground 500 VAC Output to Ground
Switching Frequency	• 120 kHz typical for PFC and PWM
Power Density	• 4.96 W/In <sup>3</sup>
Signals	• AC OK, DC OK, Remote On/Off (see control and supervisory signals)
MTBF	• 255 kHrs per MIL-HDBK-217F at $+25$ °C

### Environmental

Operating Temperature	• 0 °C to $+70$ °C, (see derating curve) Full power to $+50$ °C
Cooling	• 250 W with 18 CFM airflow 200 W convection cooling
Operating Humidity	• 5-95% RH, non-condensing
Storage Temperature	• $-20$ °C to $+85$ °C
Operating Altitude	• 3000 m
Vibration	• 2 g, 10 Hz to 55 Hz, 3 mins/cycle for 30 mins each axis

### EMC & Safety

Emissions	• EN55022, level B conducted FCC 20780, level B conducted
Harmonic Currents	• EN61000-3-2
Voltage Flicker	• EN61000-3-3
ESD Immunity	• EN61000-4-2, level 3 Perf Criteria A
Radiated Immunity	• EN61000-4-3, 10 V/m Perf Criteria A
EFT/Burst	• EN61000-4-4, level 3 Perf Criteria A
Surge	• EN61000-4-5, level 3 Perf Criteria A
Safety Approvals	• EN60950-1:2001, UL60950-1, CSA C22.2 No. 60950-1-03, CE Mark LVD

## Models and Ratings

## JPS250 - Single Output XP

Output Power <sup>(1)</sup>	Output Voltage	Output Current		Ripple & Noise Pk-Pk	Efficiency	Model Number <sup>(2)</sup>
		Convection-cooled	18 CFM			
225 W	5 V	36.0 A	45.0 A	50 mV	83%	JPS250PS05C†^
250 W	12 V	17.0 A	21.0 A	120 mV	86%	JPS250PS12C†^
	15 V	13.5 A	17.0 A	120 mV	87%	JPS250PS15C†^
	24 V	8.5 A	10.4 A	200 mV	88%	JPS250PS24C†^
	48 V	4.3 A	5.2 A	200 mV	88%	JPS250PS48C†^

### Notes

1. Maximum power with 18 CFM forced air is 250 W, or 200 W with convection cooling.
2. For non-current share version delete suffix 'C' from model number.

† Available from Farnell. See pages 204-206.

^ Available from Newark. See pages 207-208.

## Mechanical Details

All dimensions are in inches (mm) Tolerance: ± 0.03 (0.8) max Weight: 1.65 lbs (750 g) approx.

### All models (except JPS250PS05)

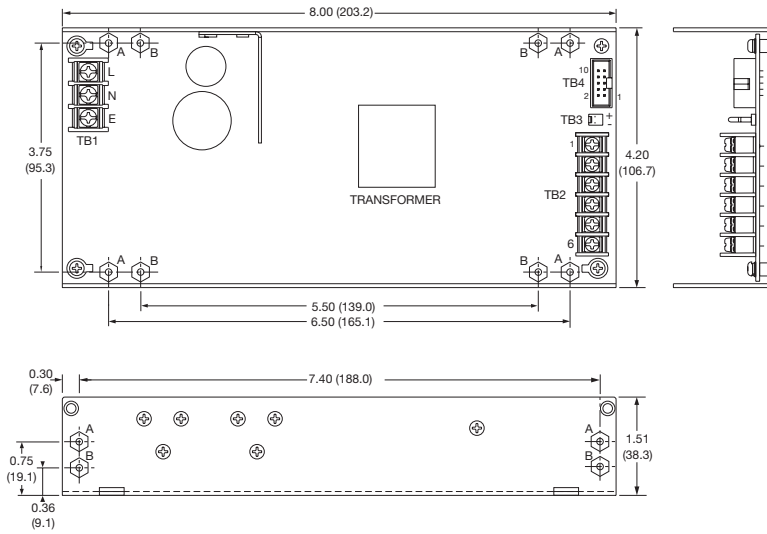

PIN CONNECTIONS			
Pin	TB2		TB4
	JPS250PS05	All other models	All models
1	+5 V	+V	Signal 0 V
2	+5 V	+V	DC OK
3	0 V	+V	AC OK
4	0 V	0 V	Remote On/Off
5	0 V	0 V	+Sense
6	0 V	0 V	-Sense
7	+5 V		Current Share <sup>(6)</sup>
8	+5 V		N/C
9			N/C
10			N/C

### Notes:

1. TB3 is for fan, with Molex 5045-02A or equivalent.
2. TB1 (AC input) and TB2 (DC output) are terminal blocks.
3. TB4 signal connector is Molex 70246-10 or equivalent.
4. Maximum mounting screw penetration is 0.16 (4.0) from chassis outer surface.
5. Fan/Cover option available, order part number:  
5 V models: JPS250 F/CVR 5†^  
12, 15 & 48 V models: JPS250 F/CVR†^  
24 V models: JPS250 F/CVR 24†^  
Or add suffix '-E' to model number to receive unit with cover fitted.
6. For current share operation connect signal 0 V (pin 1) between units and current share (pin 7) between units. For non 'C' models pin 7 (single wire parallel) is not used.

### Fixing Holes:

- A = #6-32 screw mounting holes
- B = M3 x 0.5 screw mounting holes

### JPS250PS05

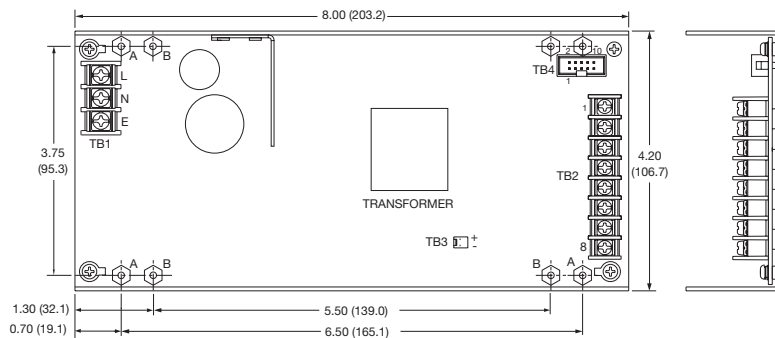

## Application Notes

### Derating Curve

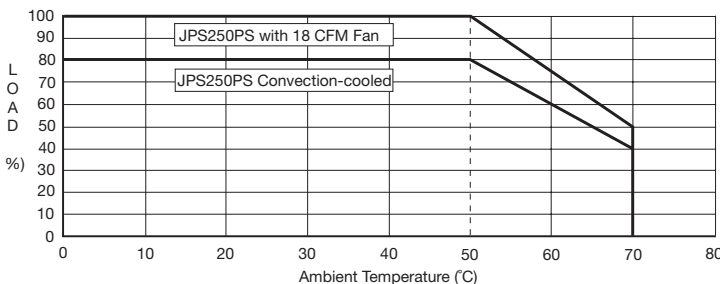

### Signals

1. To turn off the output, apply 5 V to the remote On/Off.
2. AC OK is a TTL signal which goes LOW when input falls below 60 VAC at rated load.
3. DC OK is a TTL signal which goes LOW when PSU is in an overcurrent condition, overvoltage condition, disabled or when output falls out of regulation.
4. For AC OK and DC OK signals, source current is 1 mA, sink current is 6 mA.

## Models and Ratings

Output 1			Output 2			Output 3			Output 4			Model Number <sup>(2,3)</sup>
Output V1	Conv. Cooled	Max 18 CFM	Output V2	Conv. Cooled	Max 18 CFM	Output V3	Conv. Cooled	Max 18 CFM	Output V4	Conv. Cooled	Max 18 CFM	
3.3 V	16.0 A	20 A	5 V	12 A	20 A	12 V	5 A	6 A	-12 V	1 A	2 A	JPS250PQ46†^
5.0 V	17.5 A	30 A	12 V	7 A	8 A	-12 V	2 A	3 A	-5 V	1 A	2 A	JPS250PQ41†^
5.0 V	20.0 A	25 A	12 V	4 A	6 A	24 V	2 A	3 A	-12 V	1 A	2 A	JPS250PQ47†^
5.0 V	20.0 A	25 A	15 V	3 A	5 A	24 V	2 A	3 A	-15 V	1 A	2 A	JPS250PQ48†^

### Notes

1. Maximum power with 18 CFM forced air is 250 W, or 200 W with convection cooling.
  2. For current share option add suffix 'C' to model number.
  3. Current share models are built to order.
  4. All models require 2 A minimum load on V1. On V2, JPS250PQ46 requires 1 A and JPS250PQ41 requires 0.5 A.
- † Available from Farnell. See pages 204-206.      ^ Available from Newark. See pages 207-208.

## Mechanical Details

All dimensions are in inches (mm). Tolerance: ± 0.03 (0.8) max. Weight: 1.65 lbs (750 g) approx.

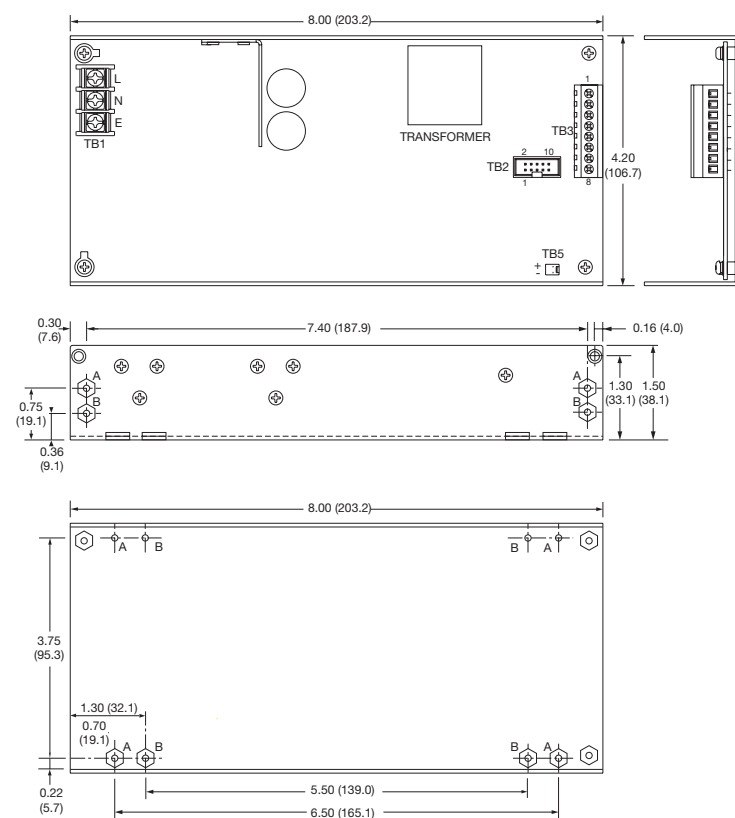

### Fixing Holes:

- A = #6-32 screw mounting holes
- B = M3 x 0.5 screw mounting holes

PIN CONNECTIONS - TB2				
Pin	PQ41	PQ46	PQ47	PQ48
1	+5 V +S	+3.3 V +S	+5 V +S	+5 V +S
2	+5 V PS <sup>(6)</sup>	+5 V -S	+5 V PS <sup>(6)</sup>	+5 V PS <sup>(6)</sup>
3	+12 V +S	+3.3 V PS <sup>(6)</sup>	+12 V +S	+15 V +S
4	DC OK	DC OK	DC OK	DC OK
5	+12 V -S	+5 V +S	+12 V -S	+15 V -S
6	+5 V -S	+3.3 V -S	+5 V -S	+5 V -S
7	+12 V PS <sup>(6)</sup>	+5 V PS <sup>(6)</sup>	+12 V PS <sup>(6)</sup>	+15 V PS <sup>(6)</sup>
8	Remote On/Off	Remote On/Off	Remote On/Off	Remote On/Off
9	AC OK	AC OK	AC OK	AC OK
10	0 V	0 V	0 V	0 V

PIN CONNECTIONS - TB3				
Pin	PQ41	PQ46	PQ47	PQ48
1	+5 V	+12 V	+5 V	+5 V
2	+5 V	-12 V	+5 V	+5 V
3	0 V	+5 V	0 V	0 V
4	0 V	+5 V	0 V	0 V
5	0 V	0 V	0 V	0 V
6	-5 V	0 V	-12 V	-15 V
7	-12 V	0 V	+24 V	+24 V
8	+12 V	0 V	+12 V	+15 V
9		+3.3 V		
10		+3.3 V		

### Notes:

1. TB5 is for fan with Molex 5045-02A or equivalent.
2. TB1 (AC input) and TB3 (DC output) are terminal blocks.
3. TB2 signal connector is Molex 70246-10 or equivalent.
4. Maximum mounting screw penetration is 0.16 (4.0) from chassis outer surface.
5. Fan/Cover option available, order part number: PQ41, PQ46 & PQ47: JPS250 F/CVR† PQ48: JPS250 F/CVR 24† or add suffix '-E' to model number to receive unit with cover fitted.
6. PS - Single wire parallel on 'C' models only. No connection on standard models.

## Application Notes

### Derating Curve

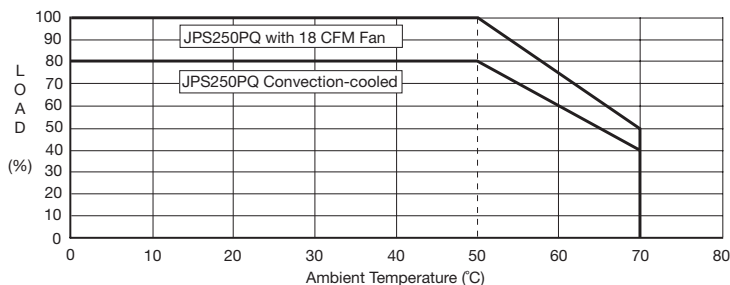

### Signals

1. To turn off the output, apply 5 V to the remote On/Off.
2. AC OK is a TTL signal which goes LOW when input falls below 60 VAC at rated load.
3. DC OK is a TTL signal which goes LOW when PSU is in an overcurrent condition, overvoltage condition, disabled or when output falls out of regulation.
4. For AC OK and DC OK signals, source current is 1 mA, sink current is 6 mA.

## Control & Supervisory Signals

### AC OK Signal

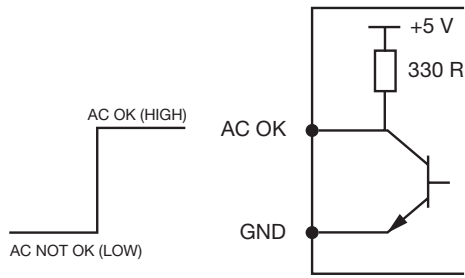

### DC OK Signal

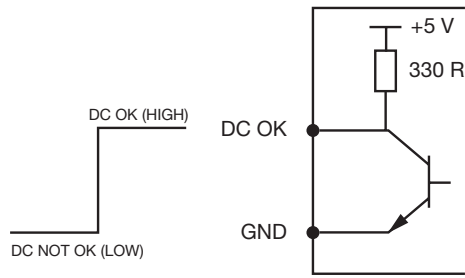

### Remote On/Off Control (Inhibit)

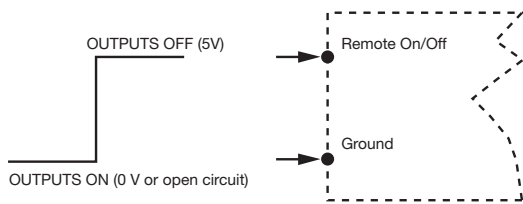

### Parallel Connection Utilizing Optional Current Share

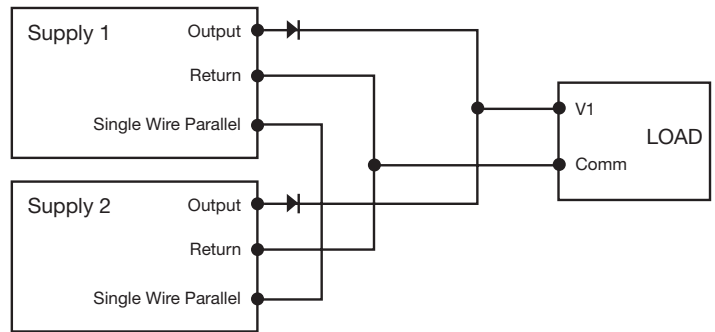

### Remote Sense Connection

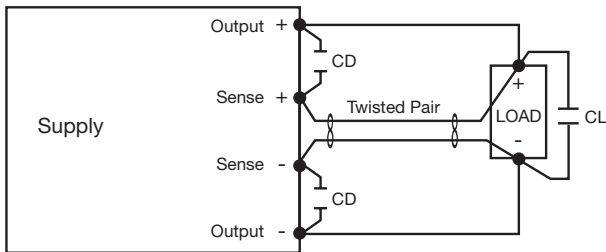

- Notes:**
1. CD is 0.1 μF ceramic capacitor.
  2. CL is 47 μF electrolytic capacitor.

## JPS250 Fan/Cover Option

See mechanical details notes for information on how to order.

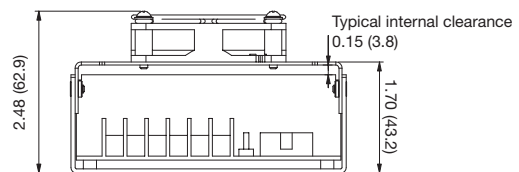
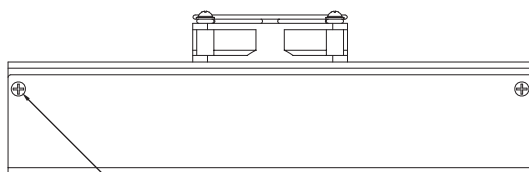
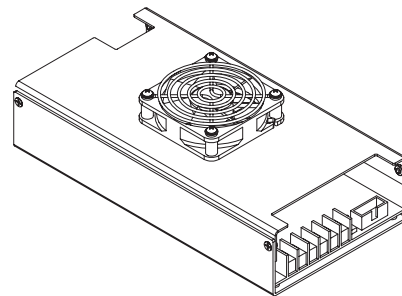
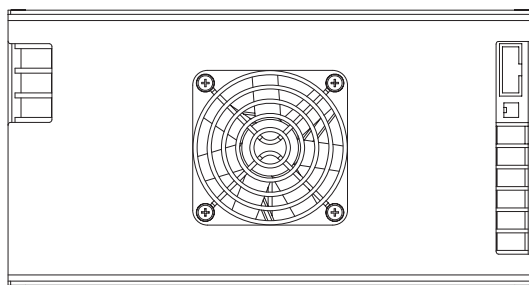

4 x M3 x 6 C/S head fixing screws in existing countersunk holes