

RoHS Compliant Product
 A suffix of "-C" specifies halogen and lead-free

DESCRIPTION

Designed to protect voltage sensitive electronic components from ESD and other transients. Excellent clamping capability, low leakage, low capacitance, and fast response time provide the best class protection on designs that are exposed to ESD.

The combination of small size, low capacitance, and high level of ESD protection makes them a flexible solution for applications such as USB 3.0 power and data line, video line and WAN/LAN equipment. It is designed to replace multi-layer varistors (MLV) in consumer equipment applications such as mobile phone, notebook, PAS, STB, LCD TV etc.

FEATURES

- Uni-directional ESD protection of two lines
- Low capacitance: 0.8pF(Max)
- Low reverse stand-off voltage: 5V

APPLICATIONS

- USB 2.0 power and data line protection
- WAN/LAN equipment
- Mobile phone

MARKING

U5V0

PACKAGE INFORMATION

Package	MPQ	Leader Size
SOT-143	3K	7 inch

SOT-143

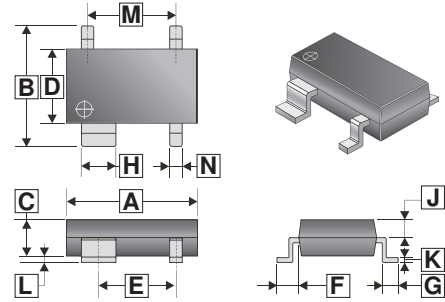

REF.	Millimeter		REF.	Millimeter	
	Min.	Max.		Min.	Max.
A	2.80	3.00	H	0.75	0.90
B	2.25	2.55	J	-	-
C	0.90	1.10	K	0.08	0.16
D	1.20	1.40	L	-	0.10
E	1.60	2.00	M	1.90	REF.
F	0.57	REF.	N	0.30	0.50
G	0.40	REF.			

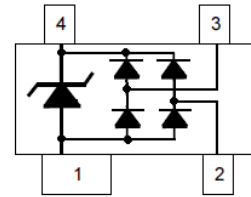

ABSOLUTE MAXIMUM RATINGS ($T_A=25^{\circ}\text{C}$ unless otherwise specified)

Rating		Symbol	Value	Unit
IEC 61000-4-2 ESD Voltage@ I/O-GND and V_{CC} -GND ¹	Air model	V_{ESD}	± 25	kV
	Contact model		± 25	
JESD22-A114-B ESD Voltage@ I/O-GND and V_{CC} -GND ¹	Per human body model		± 16	
ESD Voltage@ I/O-GND and V_{CC} -GND ¹	Machine model		± 0.4	
Peak Pulse Power ²		P_{PK}	90	W
Peak Pulse Current ²		I_{PP}	3.5	A
Maximum Lead Solder Temperature@10-second duration		T_L	260	$^{\circ}\text{C}$
Junction and Storage Temperature Range		T_J, T_{STG}	150, -55~150	$^{\circ}\text{C}$

Notes:

1. Device stressed with ten non-repetitive ESD pulses.
2. Non-repetitive current pulse 8/20 μs exponential decay waveform according to IEC61000-4-5.

ELECTRICAL CHARACTERISTICS ($T_A=25^\circ\text{C}$ and per channel(I/O to GND) unless otherwise specified)

Parameter	Symbol	Min.	Typ.	Max.	Unit	Condition
Reverse Stand Off Voltage ¹	V_{RWM}	-	-	5	V	
Reverse Leakage Current	I_R	-	-	1	μA	$V_{RWM}=5\text{V}$, I/O-GND & V_{CC} -GND
Reverse Breakdown Voltage	V_{BR}	6	-	10	V	$I_T=1\text{mA}$
		5	-	12		$I_T=1\text{mA}$, V_{CC} -GND
Forward Voltage	V_F	0.4	-	1.5	V	$I_F=10\text{mA}$, I/O-GND & V_{CC} -GND
Clamping Voltage ²	V_C	-	-	13	V	$I_{PP}=1\text{A}$, I/O-GND & V_{CC} -GND
		-	-	25		$I_{PP}=3.5\text{A}$, I/O-GND & V_{CC} -GND
Junction Capacitance	C_J	-	-	0.8	pF	$V_R=0$, $f=1\text{MHz}$
		-	-	0.4		$V_R=0$, $f=1\text{MHz}$, I/O-I/O

Notes:

- Other voltages available upon request.
- Non-repetitive current pulse 8/20 μs exponential decay waveform according to IEC61000-4-5.

ESD STANDARDS COMPLIANCE

IEC61000-4-2 Standard

Contact Discharge		Air Discharge	
Level	Test Voltage kV	Level	Test Voltage kV
1	2	1	2
2	4	2	4
3	6	3	8
4	8	4	15

JESD22-A114-B Standard

ESD Class	Human Body Discharge V
0	0~249
1A	250~499
1B	500~999
1C	1000~1999
2	2000~3999
3A	4000~7999
3B	8000~15999

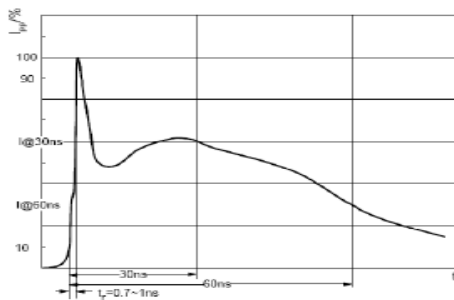

ESD pulse waveform according to IEC61000-4-2

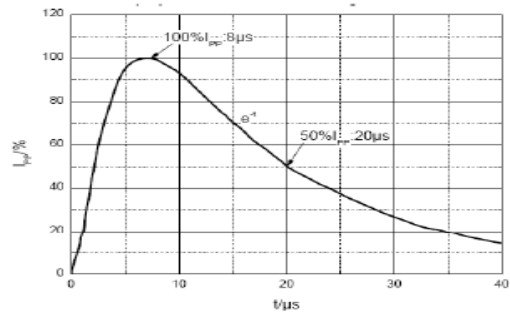

8/20 μs pulse waveform according to IEC 61000-4-5

Symbol	Parameter
V_C	Clamping Voltage @ I_{PP}
I_{PP}	Peak Pulse Current
V_{BR}	Breakdown Voltage @ I_T
I_T	Test Current
I_R	Reverse Leakage Current @ V_{RWM}
V_{RWM}	Reverse Standoff Voltage
V_F	Forward Voltage @ I_F
I_F	Forward Current

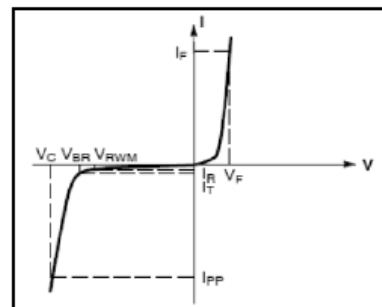

V-I characteristics for a uni-directional TVS

RATINGS AND CHARACTERISTICS CURVES

Forward Characteristics

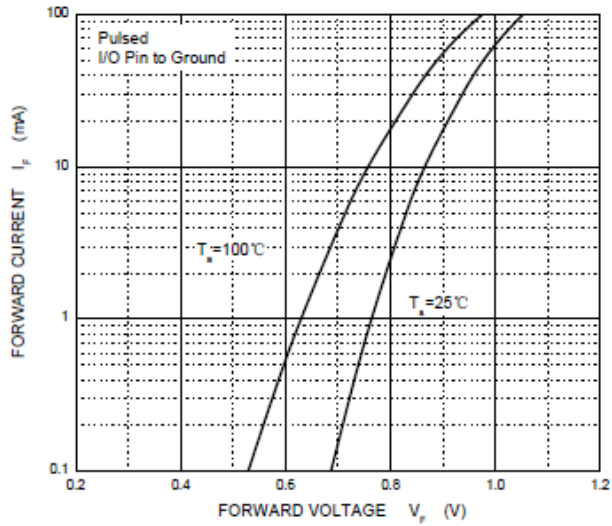

Forward Characteristics

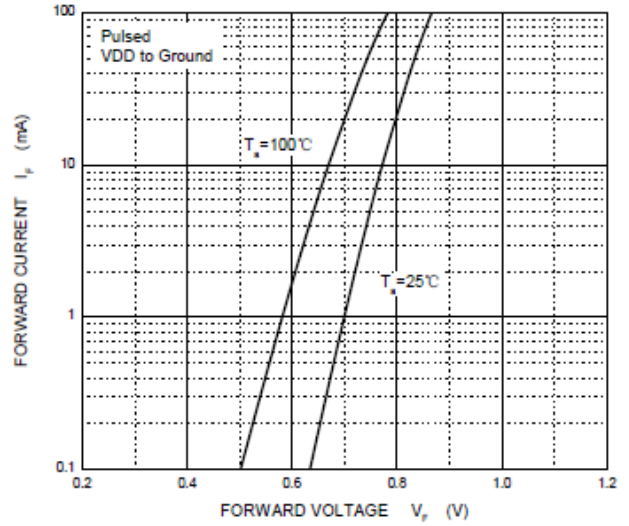

Reverse Characteristics

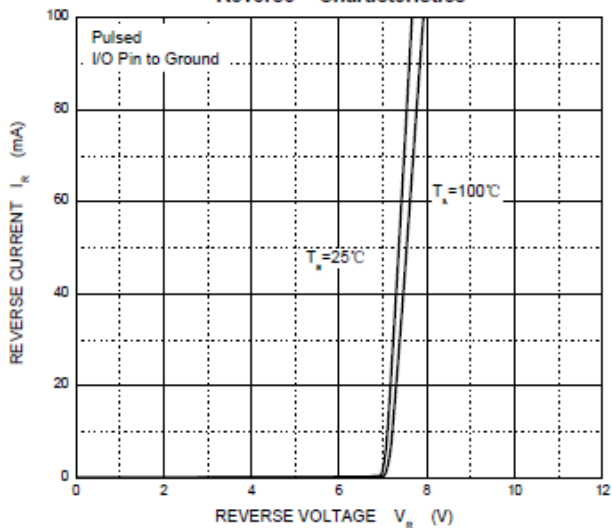

Reverse Characteristics

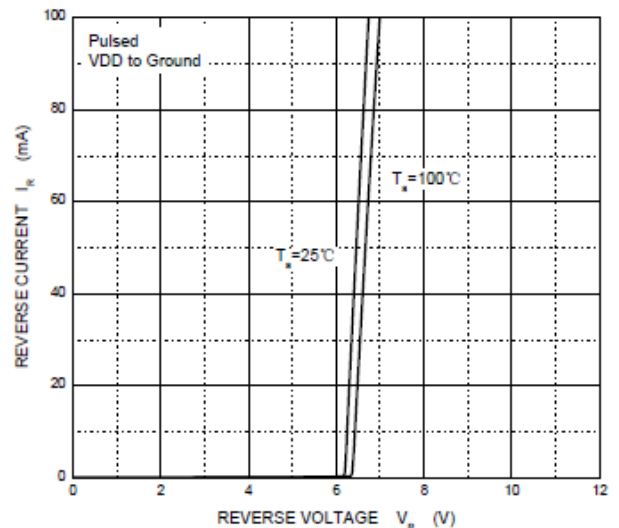

V_C — I_{PP}

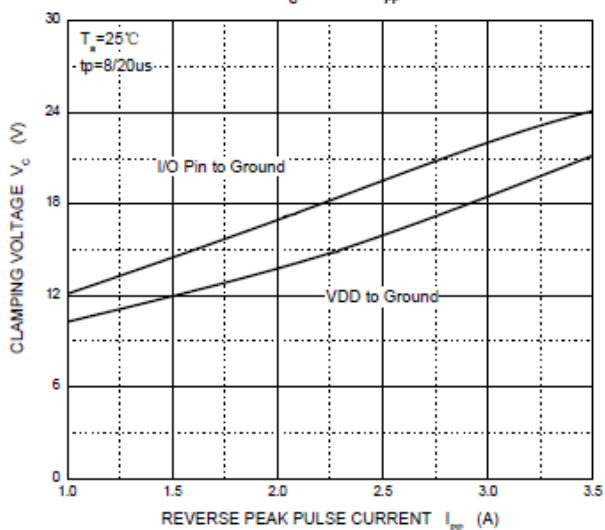

Capacitance Characteristics

