

Infrared LED

L4492

Low forward voltage LED for camera auto-focus



Features

- High radiant output power
- Low forward voltage: 2.4 V ($I_F=1.0$ A)
- High radiant output power by constant voltage drive
- Small emission spot (reflector size)

Applications

- Auto-focus

■ Absolute maximum ratings ($T_a=25$ °C)

Parameter	Symbol	Condition	Value	Unit
Forward current	I_F		80	mA
Reverse voltage	V_R		3	V
Pulse forward current	I_{FP}	Pulse width=10 μ s Duty ratio=1 %	1.0	A
Operating temperature	T_{opr}		-30 to +85	°C
Storage temperature	T_{stg}		-40 to +100 *	°C

* Guaranteed to resist temperature cycle test of up to 5 cycles.

■ Electrical and optical characteristics ($T_a=25$ °C)

Parameter	Symbol	Condition	Min.	Typ.	Max.	Unit
Peak emission wavelength	λ_p	$I_F=50$ mA	880	900	930	nm
Spectral half width	$\Delta\lambda$	$I_F=50$ mA	-	60	-	nm
Forward voltage	V_F	$I_F=50$ mA	-	1.35	1.45	V
Pulse forward voltage	V_{FP}	$I_F=1.0$ A	-	2.4	2.8	V
Reverse current	I_R	$V_R=3$ V	-	-	30	μ A
Radiant flux	ϕ_e	$I_F=50$ mA	6.0	8.0	-	mW
Radiant illuminance	P_E	$I_F=50$ mA	-	1.1	-	mW/cm ²
Rise time	t_r	$I_F=50$ mA, 10 to 90 %	-	0.45	0.7	μ s
Fall time	t_f	$I_F=50$ mA, 90 to 10 %	-	0.45	0.7	μ s

Emission spectrum

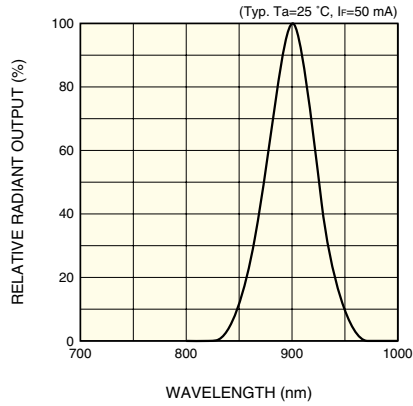

KLEDB0138EB

Radiant flux vs. forward current

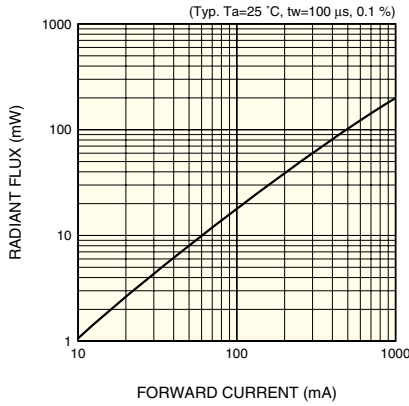

KLEDB0197EA

Forward current vs. forward voltage

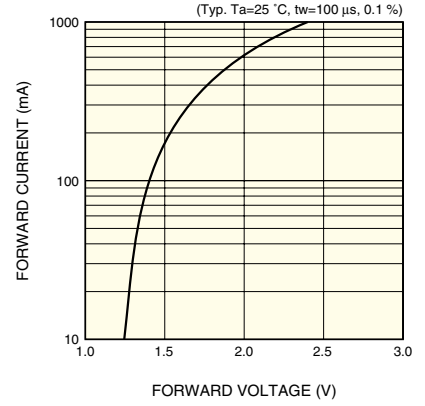

KLEDB0198EA

Directivity

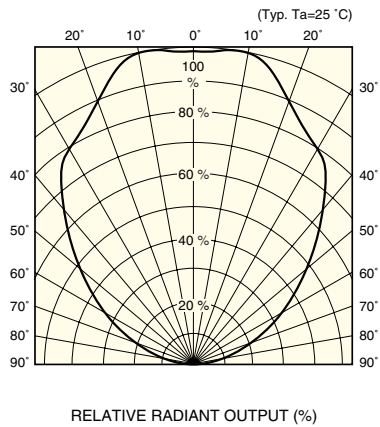

KLEDB0199EA

Radiant output vs. ambient temperature

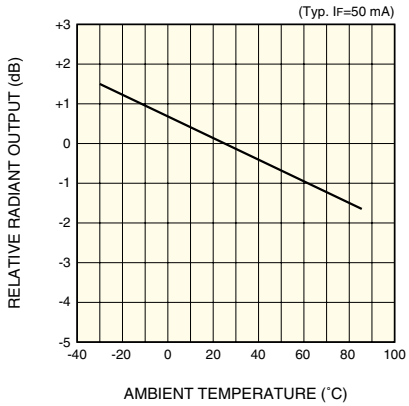

KLEDB0200EA

Allowable forward current vs. ambient temperature

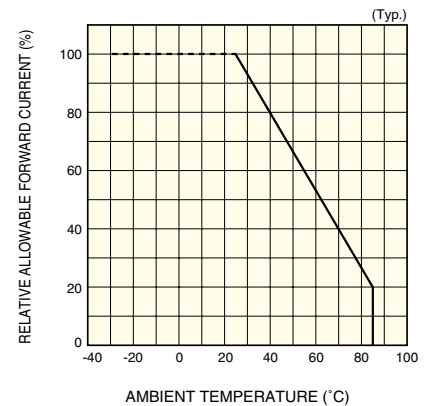

KLEDB0027EB

Allowable forward current vs. duty ratio

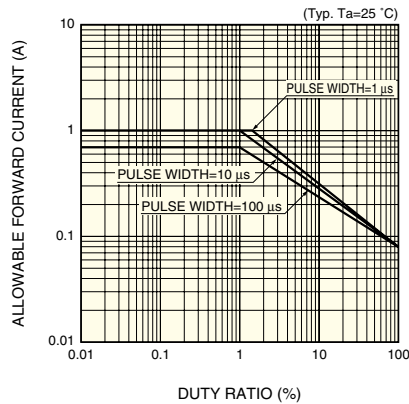

KLEDB0038EA

Dimensional outline (unit: mm)

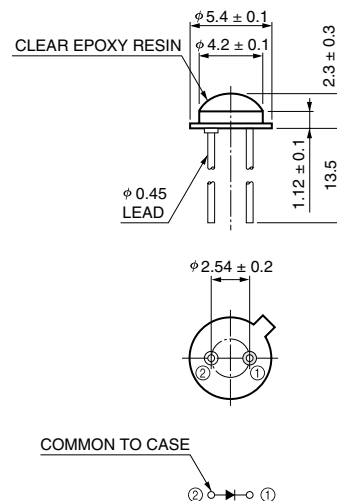

KLEDA0009ED