



LA4192

1 to 2.3W 2-Channel of Power Amplifier

Features

- Has two channels that can be used for either stereo or bridge amplifier.
- High outputs : LA4192 provides 2.3W per channel for 2 channel stereo connected at $V_{CC}=9V$, $R_L=4\Omega$, or 4.7W bridge amplifier (for $R_L=8\Omega$).
- Voltage gain is variable by externally connected feedback resistors :
For 2-channel : $R_{NF}=27\Omega$, $VG=50dB$
Bridge amplifier connected : $R_{NF}=51\Omega$, $VG=51dB$
- Switching distortions in higher frequencies have been held low.
- The built-in muting circuit keeps noises caused by turning power on and off at low levels.
- The built-in ripple filter provides good ripple rejection factors.
- Excels in channel separation.

Package Dimensions

unit:mm

3022A-DIP12F

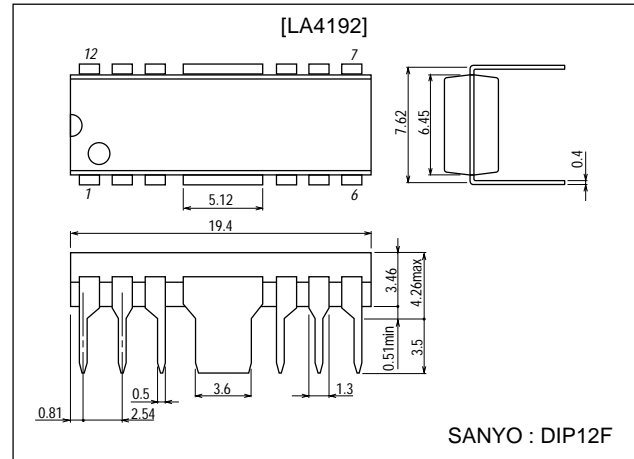

Specifications

Absolute Maximum Ratings at $T_a = 25^\circ C$

Parameter	Symbol	Conditions	Ratings	Unit
Maximum supply voltage	V_{CC} max	With signals	11	V
		With no signal	15	V
Allowable power dissipation	P_d max	With P-plate (See $P_d - T_a$ diagram)	4	W
Operating temperature	T_{opr}		-20 to +75	$^\circ C$
Storage temperature	T_{stg}		-55 to +150	$^\circ C$

Recommended Operating Conditions at $T_a = 25^\circ C$

Parameter	Symbol	Conditions	Ratings	Unit
Supply voltage	V_{CC}		9	V
Load resistance	R_L	2-channel	4 to 8	Ω
		Bridge	8	Ω

Note : Basically, this package dissipates heat by using the copper foil section of the printed circuit board, but because power dissipation P_d can be increased by power voltages and load conditions, it is recommended that a heat sink be used in conjunction with the printed circuit board.

- Any and all SANYO products described or contained herein do not have specifications that can handle applications that require extremely high levels of reliability, such as life-support systems, aircraft's control systems, or other applications whose failure can be reasonably expected to result in serious physical and/or material damage. Consult with your SANYO representative nearest you before using any SANYO products described or contained herein in such applications.
- SANYO assumes no responsibility for equipment failures that result from using products at values that exceed, even momentarily, rated values (such as maximum ratings, operating condition ranges, or other parameters) listed in products specifications of any and all SANYO products described or contained herein.

SANYO Electric Co.,Ltd. Semiconductor Company

TOKYO OFFICE Tokyo Bldg., 1-10, 1 Chome, Ueno, Taito-ku, TOKYO, 110-8534 JAPAN

21500TH (KT)/71093TS/O207KI/2146KI/4195MW, TS No.919-1/11

LA4192

Operating Characteristics at $T_a = 25^\circ\text{C}$, $V_{CC}=9\text{V}$, $f=1\text{kHz}$, $R_g=600\Omega$, $R_L=4\Omega$, () denotes values for 8Ω , in the specified test circuit

Parameter	Symbol	Conditions	Ratings			Unit
			min	typ	max	
Quiescent current	I_{CCO}	For 2 channels 6V		35	55	mA
		For 2 channels 7.5V		40		mA
Voltage gain	VG	Closed loop, $R_{NF}=27\Omega$, $V_{IN}=-51\text{dBm}$, 2-channel	48	50	52	dB
		Closed loop, $R_{NF}=27\Omega$, $V_{IN}=-51\text{dBm}$, Bridge	49	51	53	dB
Voltage gain imbalance	ΔVG	2-channel			2	dB
Output power	P_O	THD=10%, 2-channel	1.7	2.3		W
		THD=10%, 2-channel		(1.3)		
		THD=10%, Bridge		(4.7)		W
Total harmonic distortion	THD	$P_O=250\text{mW}$, 2-channel		0.5	2.0	%
Input resistance	r_i		21	30		k Ω
Output noise voltage	V_{NO}	$R_g=0$, 2-channel		0.5	1.3	mV
		$R_g=10\text{k}\Omega$, 2-channel		0.8	2.5	mV
Ripple rejection	R_r	$R_g=0$, $V_R=150\text{mV}$, 2-channel		46		dB
Channel separation	CH sep	$R_g=10\text{k}\Omega$, $v_o=0\text{dBm}$, 2-channel	40	55		dB

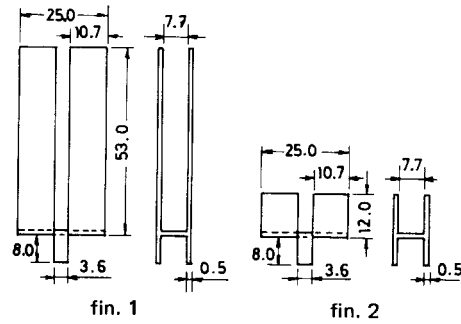
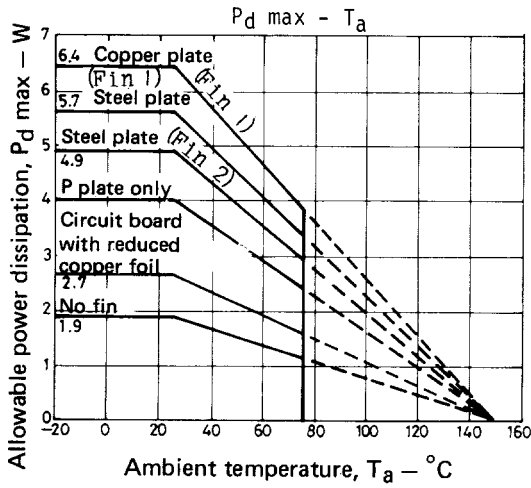

Equivalent Circuit Block Diagram

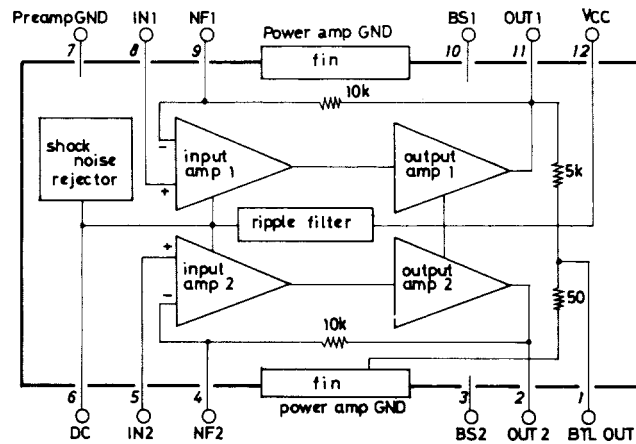

Unit (resistance: Ω)

LA4192

Sample Application Circuit 1 : For 2-channel

Unit (resistance: Ω , capacitance: F)

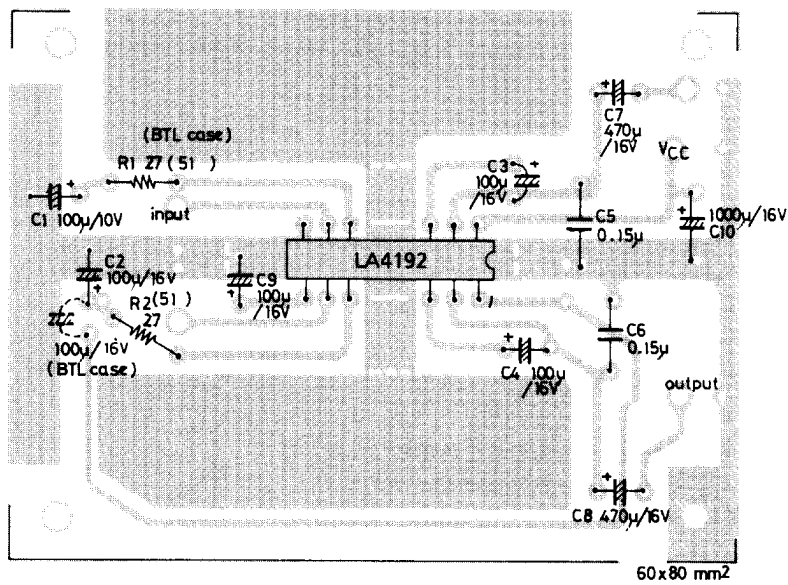
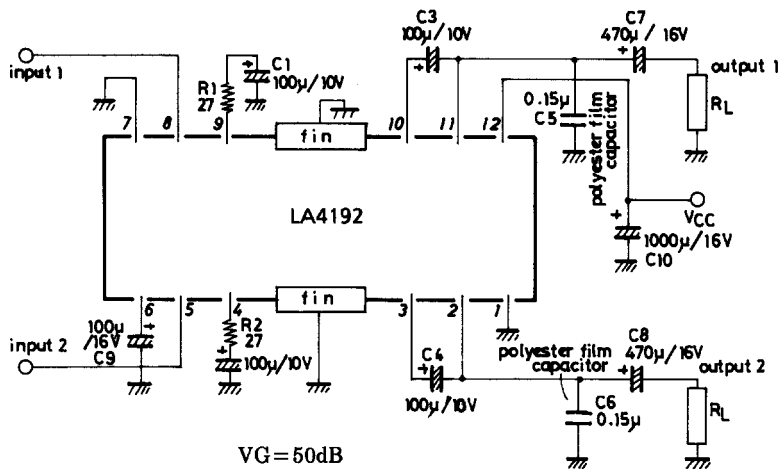

Sample printed pattern for 2 channel and bridge amp. (copper foil side)

Sample Application Circuit 2 : Bridge amplifier connected

Unit (resistance: Ω , capacitance: F)

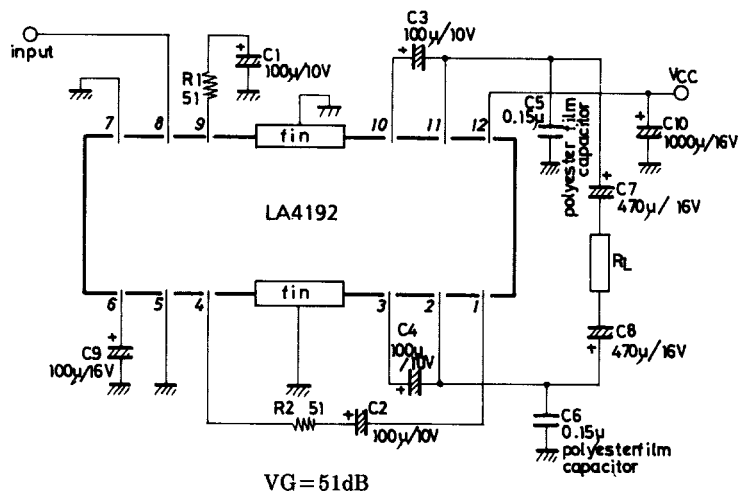

Externally connected components and comments

C1 (C2) : Feedback capacitor : The lower cut-off frequency is given by the following formula :

$$f_L = \frac{1}{2\pi C1 R_f}$$

f_L : Lower cut-off frequency
 R_f : Feedback resistance

This requires careful review, because, together with decoupling capacitor, it affects the starting time.

R1 (R2) : Feedback resistor : Voltage gain is determined by ratio to the built-in resistor. Use $\pm 5\%$ -tolerance resistors to enhance balance of voltage gains for the two channels.

C3 (C4) : Bootstrap capacitor : Capacitance affects output in the low-frequency range ; employment of small-value capacitance causes reduced outputs in lower frequencies. Employ at least $47\mu F$.

C5 (C6) : De-oscillating capacitor : Use a mylar capacitor that excels in temperature and frequency characteristics. If an aluminum electrolytic or a ceramic capacitor is used, it may cause oscillation.

C7 (C8) : Output capacitor : The lower cut-off frequency is given by the following formula :

$$f_L = \frac{1}{2\pi C7 R_L}$$

f_L : Lower cut-off frequency
 R_L : Load resistance

To obtain equivalent low-frequency characteristics for 2-channel operation with bridge amplifier connected, double the capacitance.

C9 : Decoupling capacitor : Though this is an arm of the ripple filter, rejection effects saturate at a certain value so that excessively large values do not serve any further purpose. It is employed for a time constant of the muting circuit, so it affects the starting time.

C10 : Power supply capacitor.

Concerning application circuits

1. Voltage gain adjustments

◆ 2-channel

Voltage gain is determined by resistor R1 (R2) and an externally connected feedback resistor R_f in accordance with the following formula :

$$VG = 20 \log \frac{R1 (R2)}{R_f} \text{ [dB]}$$

By suitable selection of the externally connected resistor R_f , any voltage gain can be obtained. It is preferable, however, that the voltage gain is chosen in the range of 45dB to 50dB. Incidentally, R1 (R2) = 10k Ω typ.

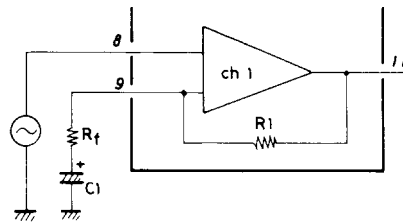

◆ Bridge Amplifier.

Unit (resistance: Ω)

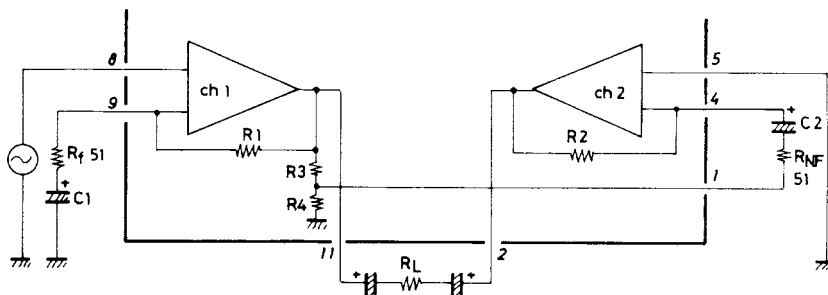

A bridge amplifier connection is structured as shown above. Ch-1 functions as a non-inverting amplifier and Ch-2 as an inverting amplifier. For input to ch-2, output of ch-1 is divided by resistors R3 and R4 and is led out at pin 1 as bridge amplifier output. Attenuation of ch-1 output is $R3/R4$, while amplification of ch-2/ $(R_{NF}+R4)$, and due to designation for R3 : 5k Ω typ., and R4 : 50 Ω typ., ch-1 output attenuation and ch-2 amplification become equal by designating $R_{NF}=51\Omega$. When obtained at ch-2, output is the same output as ch-1 but opposite in phase. Accordingly, the overall voltage gain exhibited is 6dB above ch-1 gain, and is approximately given by the following formula.

Continued on next page.

Continued from preceding page.

$$VG=20 \log \frac{R1}{R_f} +6 \text{ [dB]}$$

If designated for $R_f=27\Omega$, $VG=56\text{dB}$ will be obtained which is excessive ; it is recommended that $R_{NF}=51\Omega$ be designated when bridge amplifier is connected.

2. Crosstalk

As LA4192 is used at a voltage gain around 50dB, feedback is shallow. It is recommended that the bridge amplifier output pin (pin 1) be grounded when used for 2-channel.

3. Starting time

A built-in muting circuit suppresses shock noise when power is turned on. It utilizes time constant of C9 (decoupling capacitor), and built-in charging circuits for C1 and C2 (NF capacitors). The starting time depends on capacitances of C1 (C2) and C9 as shown below :

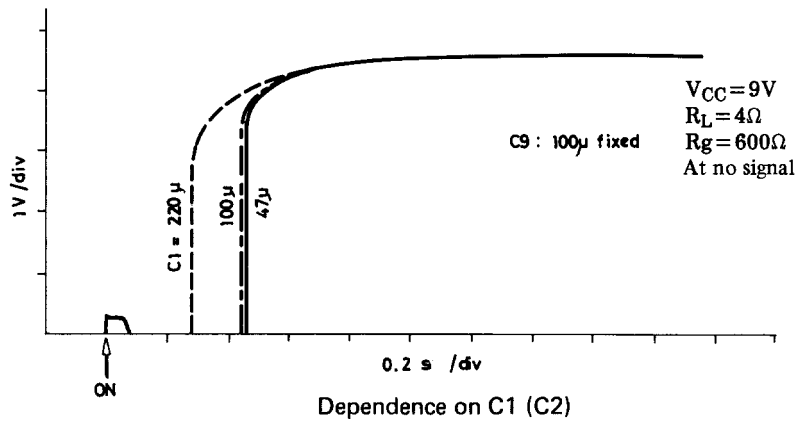
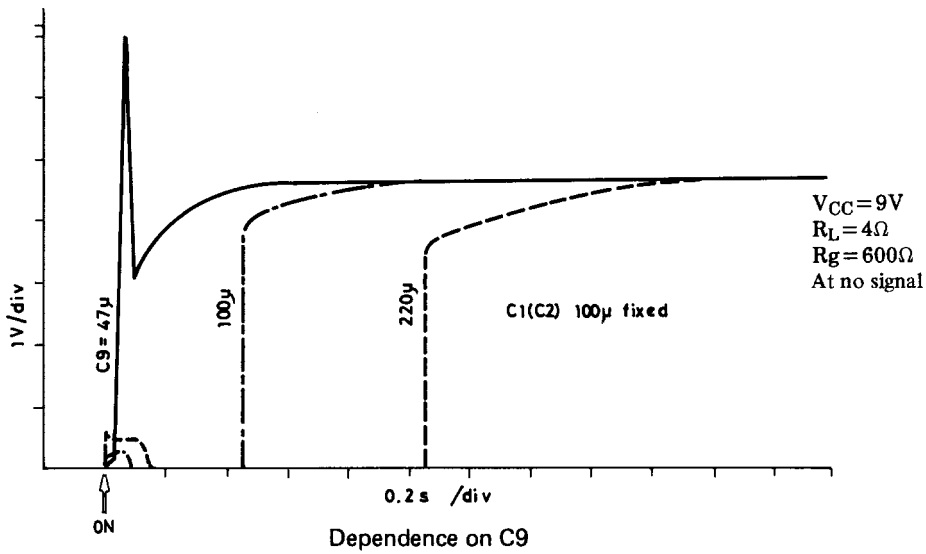

4. Cautions for use of the IC

1. When used close to the maximum ratings, even a slight variation in conditions can cause the maximum ratings to be surpassed. This leads to breakdown failures. Be sure to provide for sufficient margins to cover variations in power voltages. Use the IC in a range that never exceeds the maximum ratings.
2. Inter-pin shortcircuits
Turning the power on with inter-pin shortcircuits causes breakage or deterioration, so that when mounting the IC on a circuit board, carefully inspect to avoid inter-pin shorts caused by soldering, before turning the power on.
3. Short-circuited loads
When used for a prolonged period with a shorted load, breakage or deterioration can result. Under no circumstance should loads be left shorted.
4. When used in a radio or radio-cassette recorder, maintain a sufficient distance between the IC and a bar antenna.
5. In making a circuit board, refer to the sample printed pattern.

LA4192

• Caution for LA4192 in sets

When LA4192 is used in a set and driven by AC mains, switching the motor on as shown below, causes instantaneous lowering of the power supply voltage, depending on the transformer regulation and other conditions.

Ripple noises are sometimes generated in the speakers or headphones. The following can be used to prevent such problems.

1. Connect a diode (a rectifier diode with an average rectified current $I_O=100$ to 200mA) across pins 6 and 12 of LA4192, and have pin 6 potential closely follow power supply voltage variations. In a steady state, this diode will be cut off.
2. Use large enough capacitance capacitors for the power supply to suppress supply voltage variations caused when the motor is switched on.

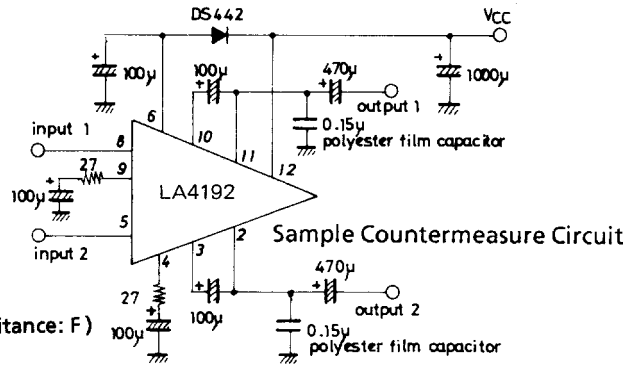

Unit (resistance: Ω , capacitance: F)

• Heat sink design

As the package is basically heat-dissipated by utilizing a copper foil section of the printed circuit board, the area of copper foil in the vicinity of the IC heat dissipating plate should be made as broad in area as possible when designing the printed circuit board. For the sample printed pattern shown earlier, providing copper coil where indicated by the broken lines will considerably enhance heat sinking. Power consumption (P_d) can be increased depending on power supply voltage and load conditions. Use of a heat sink in conjunction with the printed circuit board is recommended. Described below are formulas to provide guidelines for P_d (for 2 channels) under various conditions of usage. For AC power supplies, it is preferable to take actual measurements at the transformer of sets. For bridge amplifier, simply use 1/2 of employed loads in computations.

1) DC power supply

$$P_d \text{ max} = \frac{V_{CC2}^2}{\pi^2 R_L} + I_{CC0} \cdot V_{CC} \text{ (for 2 channels) } \dots\dots\dots (1)$$

2) AC power supply

- V_{CC2} : Power supply voltage at no signal
- $V_{CC} (P_d)$: Power supply voltage at P_d max
- V_{CC1} : Power supply voltage at maximum output
- r : Voltage regulation $\frac{V_{CC2}-V_{CC1}}{V_{CC1}}$
- I_{CC0} : Quiescent current

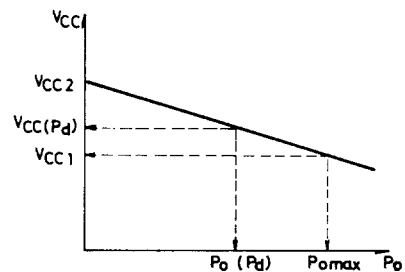

Power supply voltage variation

$$P_d \text{ max} = \frac{V_{CC(Pd)}^2}{\pi^2 R_L} + I_{CC0} \cdot V_{CC} (P_d) \text{ (for 2 channels) } \dots\dots\dots (2)$$

where

$$V_{CC} (P_d) = \frac{(1+r) V_{CC1}}{1 + \frac{r \cdot V_{CC1}}{\sqrt{2} \cdot \pi \cdot R_L} \times \sqrt{\frac{R_L}{P_{O \text{ max}}}}}$$

Sample heat sink mounting

Prepare a heat sink as shown on the next page. It is configured to be able to dissipate heat both from the IC plastic surface and its fins. Solder it on to the printed circuit board. Refer to the $P_d - T_a$ characteristics for size of heat sink. Solderable copper or steel are preferable. Silicone grease is recommended for application to the IC plastic surface to lower its thermal resistance with the heat sink.

LA4192

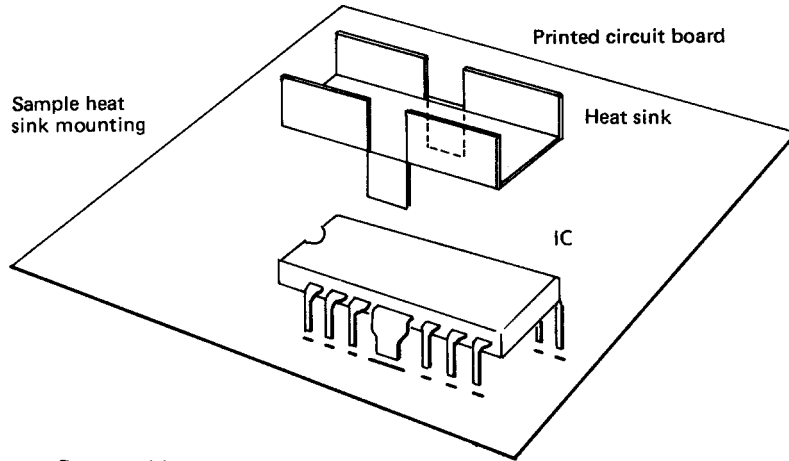

2 channel operation

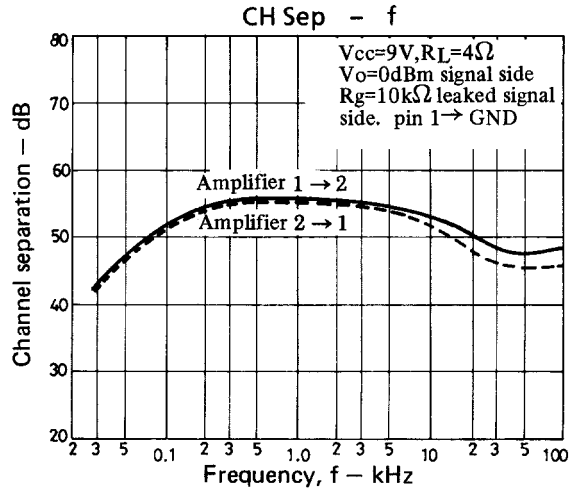
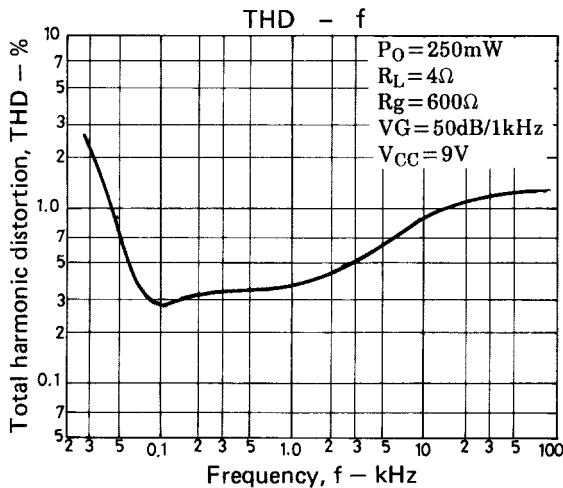
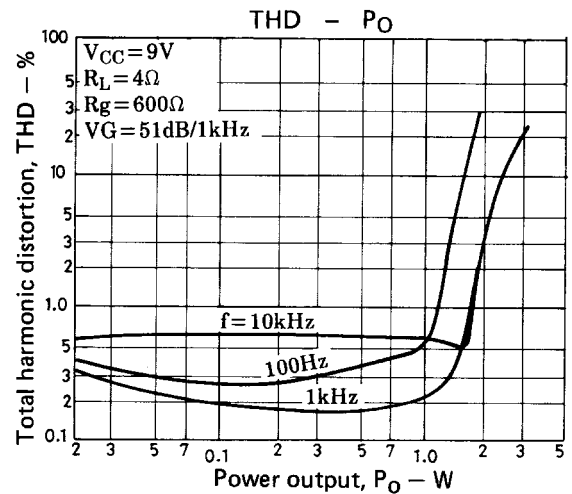
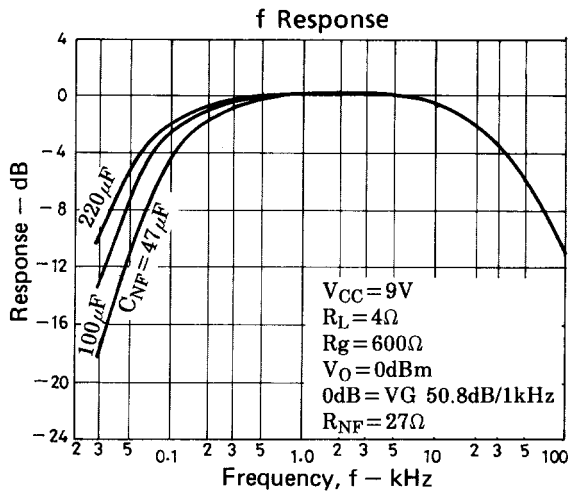
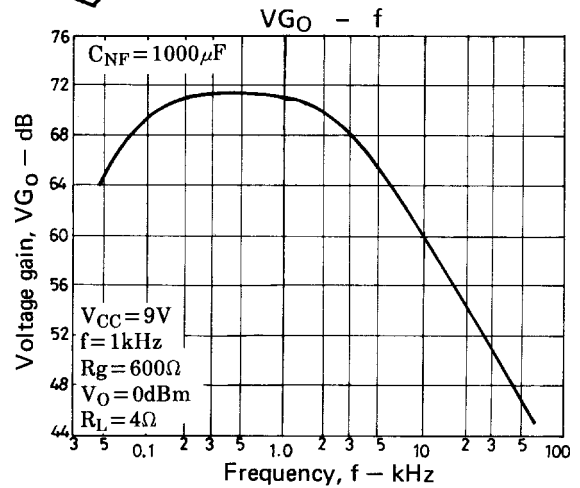
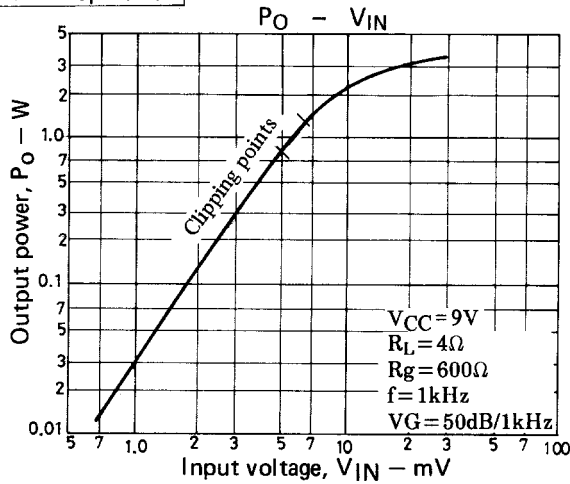

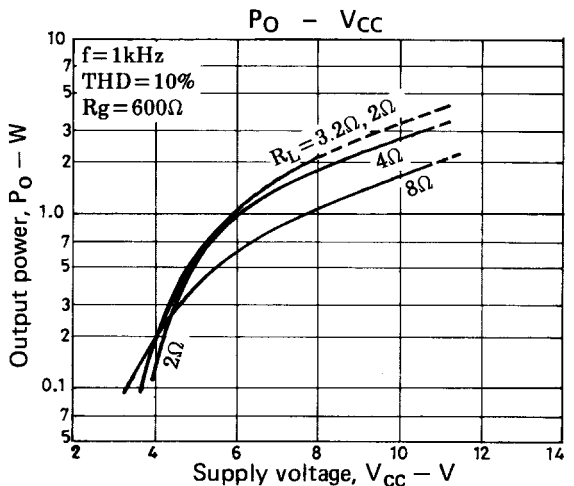
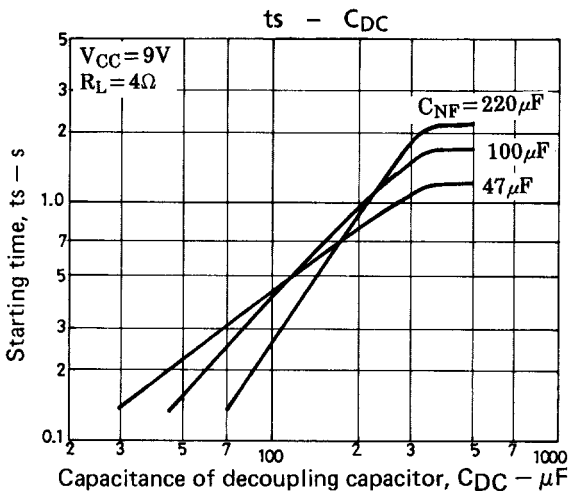
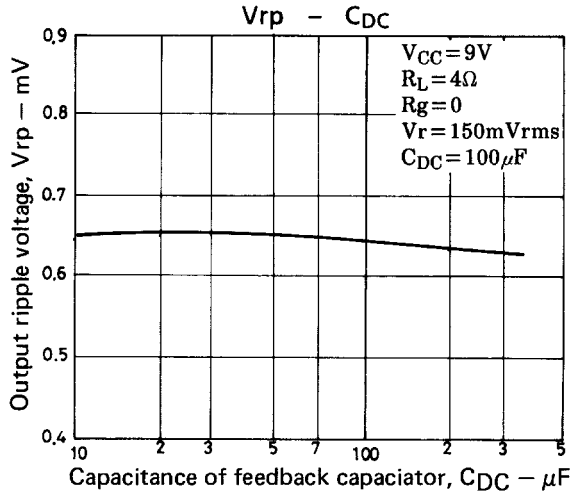
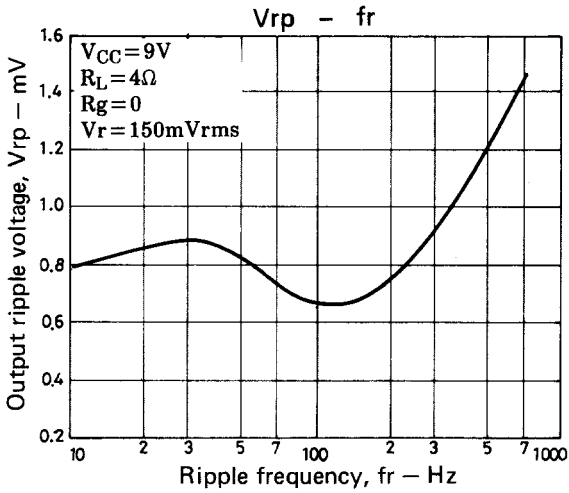
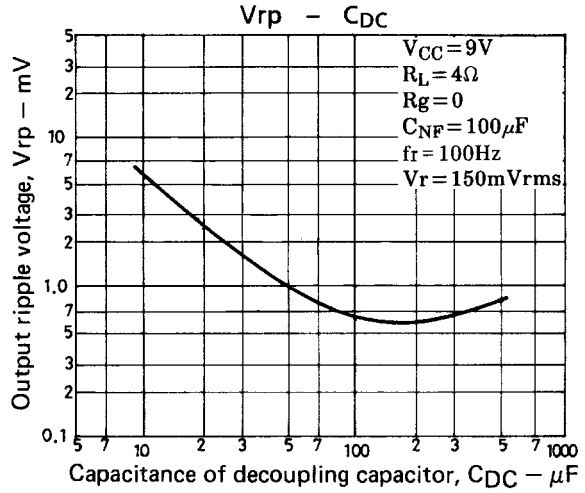
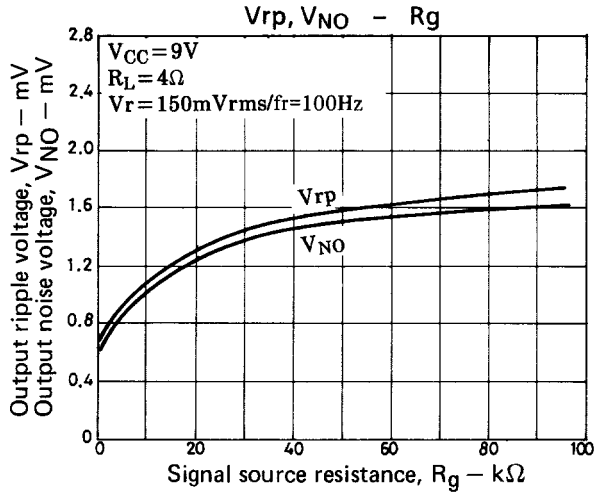
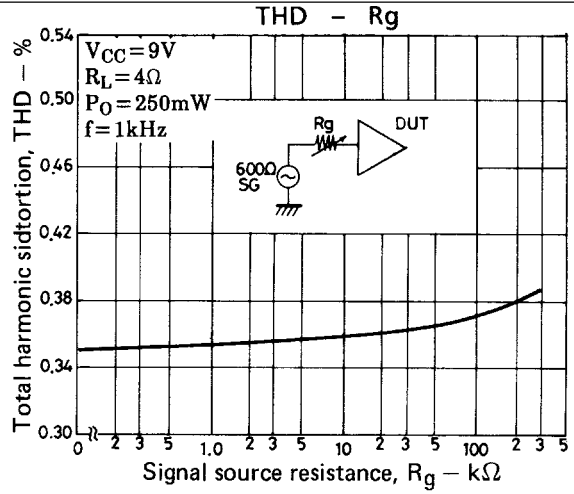
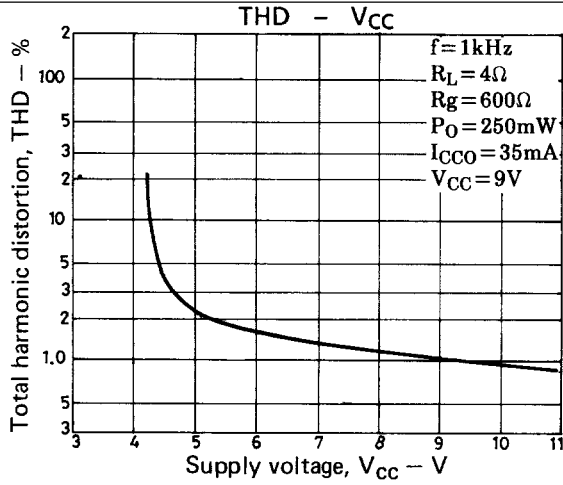

LA4192

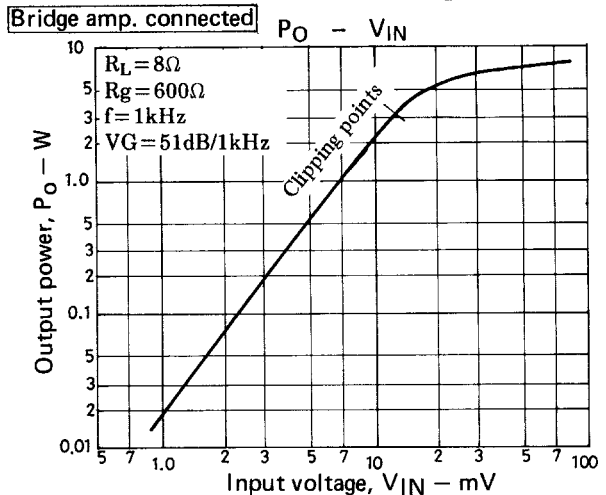
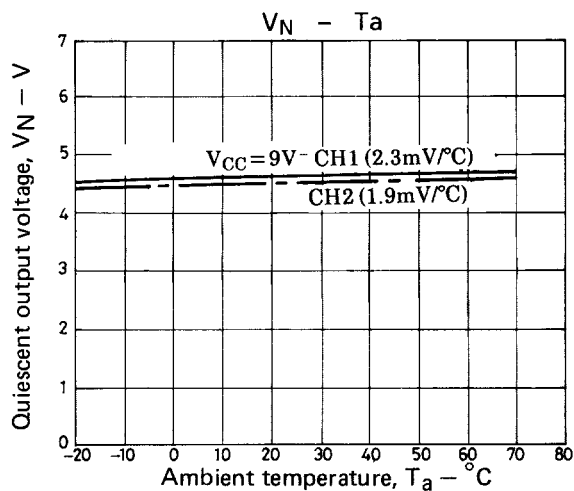
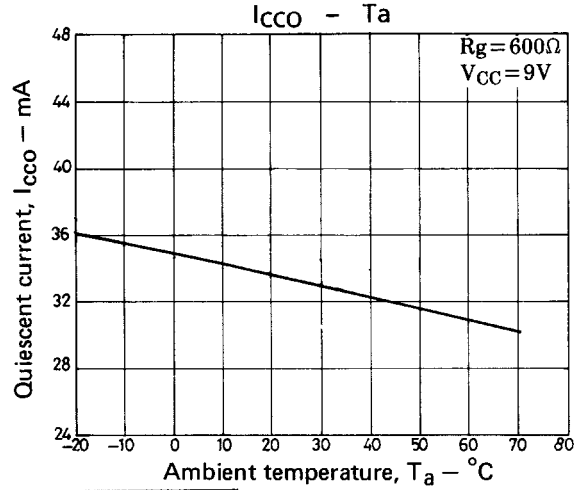
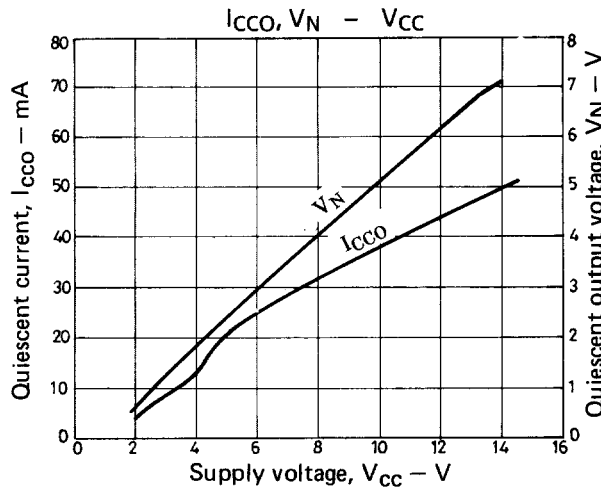
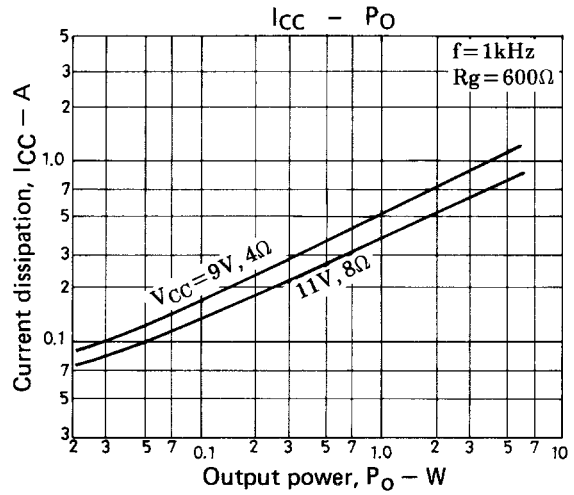
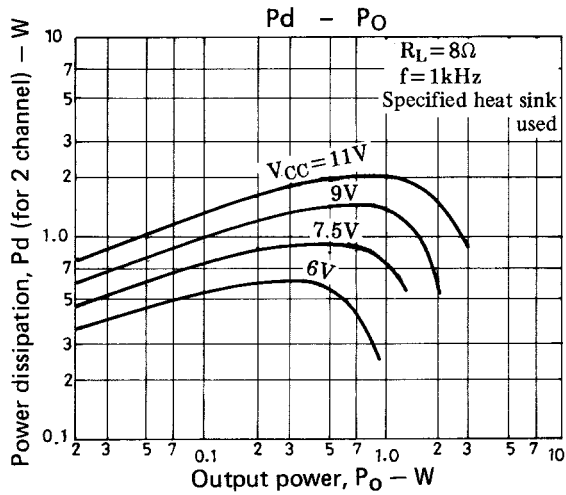
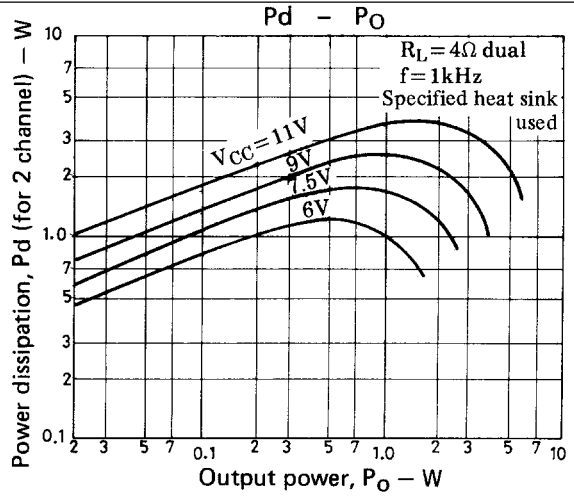
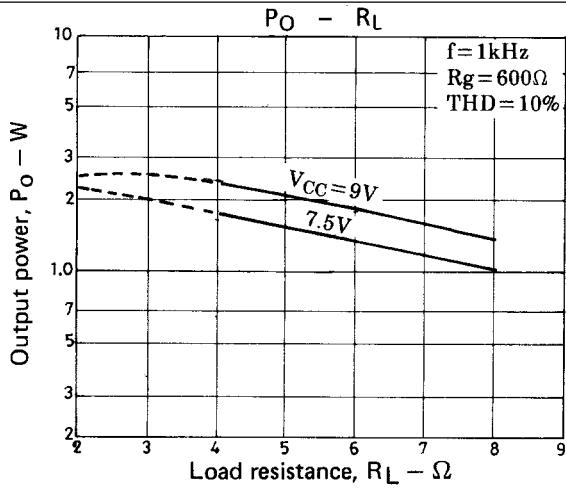

LA4192

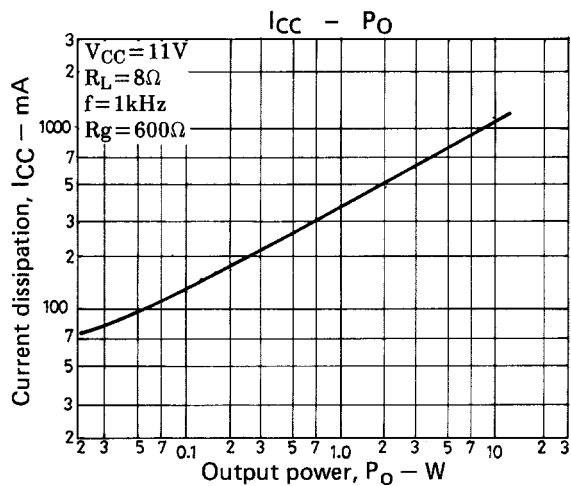
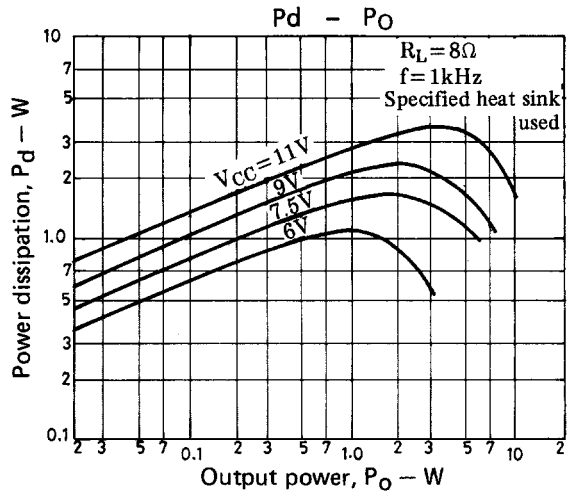
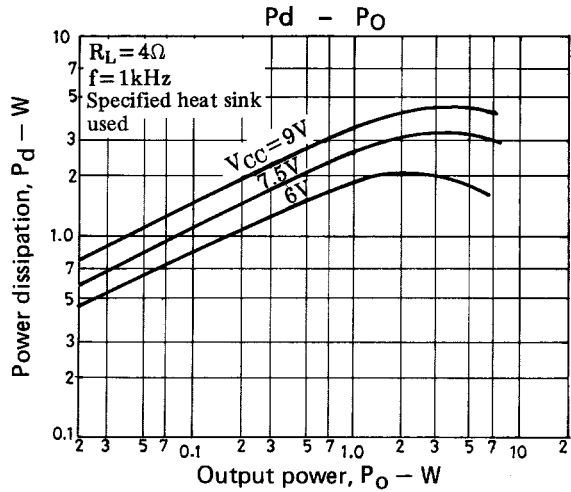
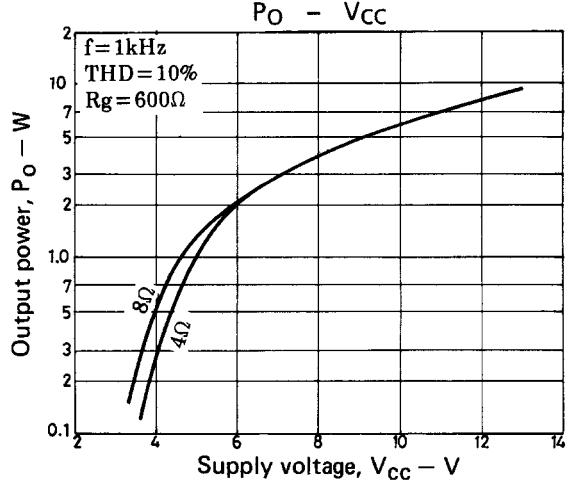
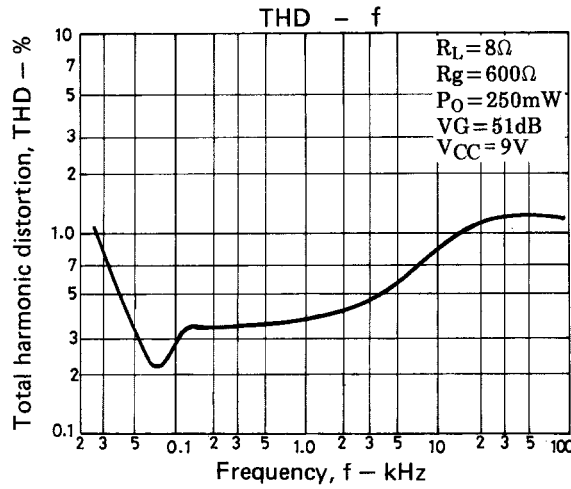
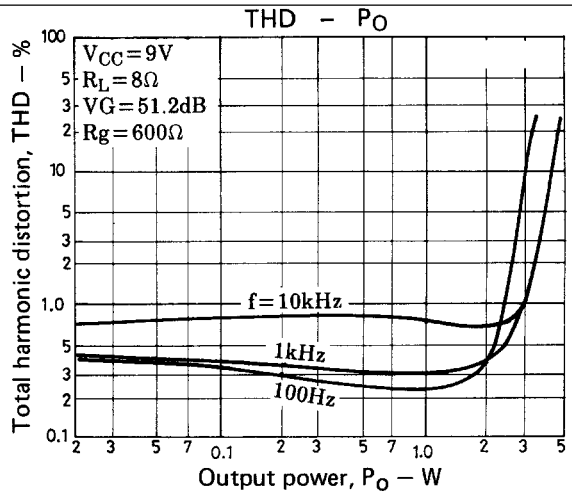
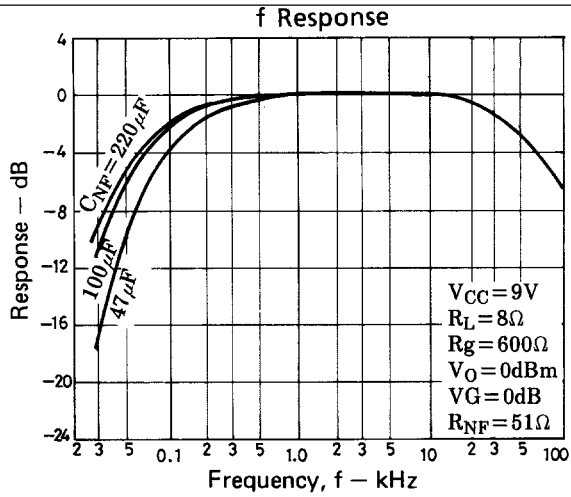

- Specifications of any and all SANYO products described or contained herein stipulate the performance, characteristics, and functions of the described products in the independent state, and are not guarantees of the performance, characteristics, and functions of the described products as mounted in the customer's products or equipment. To verify symptoms and states that cannot be evaluated in an independent device, the customer should always evaluate and test devices mounted in the customer's products or equipment.
- SANYO Electric Co., Ltd. strives to supply high-quality high-reliability products. However, any and all semiconductor products fail with some probability. It is possible that these probabilistic failures could give rise to accidents or events that could endanger human lives, that could give rise to smoke or fire, or that could cause damage to other property. When designing equipment, adopt safety measures so that these kinds of accidents or events cannot occur. Such measures include but are not limited to protective circuits and error prevention circuits for safe design, redundant design, and structural design.
- In the event that any or all SANYO products(including technical data, services) described or contained herein are controlled under any of applicable local export control laws and regulations, such products must not be exported without obtaining the export license from the authorities concerned in accordance with the above law.
- No part of this publication may be reproduced or transmitted in any form or by any means, electronic or mechanical, including photocopying and recording, or any information storage or retrieval system, or otherwise, without the prior written permission of SANYO Electric Co., Ltd.
- Any and all information described or contained herein are subject to change without notice due to product/technology improvement, etc. When designing equipment, refer to the "Delivery Specification" for the SANYO product that you intend to use.
- Information (including circuit diagrams and circuit parameters) herein is for example only ; it is not guaranteed for volume production. SANYO believes information herein is accurate and reliable, but no guarantees are made or implied regarding its use or any infringements of intellectual property rights or other rights of third parties.

This catalog provides information as of February, 2000. Specifications and information herein are subject to change without notice.