



LA7955

Video Switch for TV / VCR Use

Overview

The LA7955 Video Switch IC is used to switch the video and audio signals of TVs, VCRs and similar equipment. Separate pin layouts for the video and audio systems facilitate board design. Two signals can be selected from the three input signals in a symmetrical arrangement using a control signal. Low impedance lines (V_{CC} , GND and control input) between the input and output pins minimize crosstalk caused by the high frequency of the video section. The LA7955 operates on a 12V power supply and is available in 20-pin plastic slim DIPs.

Functions

- Video applications : 3 inputs, 2 outputs
- Audio applications : 3 inputs, 2 outputs \times 2 (L, R) channels
- Built-in muting circuits for 2 left and right audio output channels

Features

- Separate video and audio pin layouts
- Built-in 6dB video amps
- Wideband characteristics
- Minimal video and audio crosstalk
- 12V power supply
- 20-pin plastic slim DIP

Package Dimensions

unit : mm

3021B-DIP20

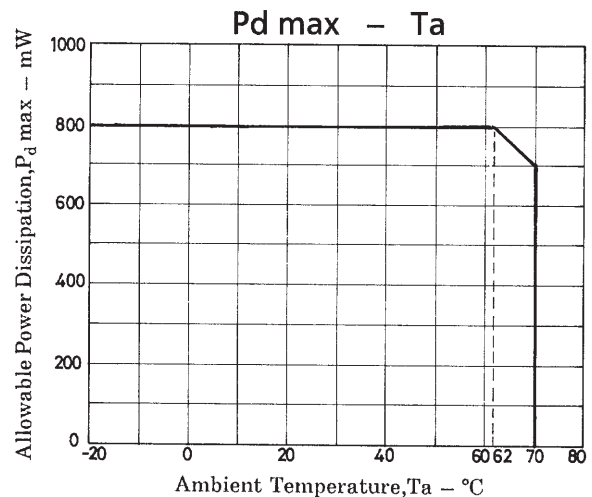
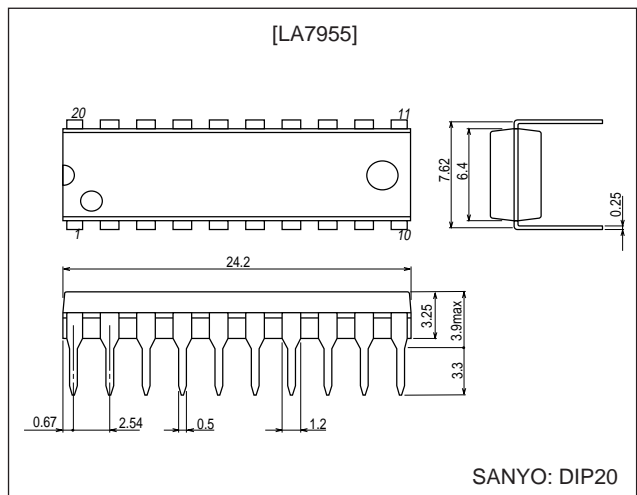

■ Any and all SANYO products described or contained herein do not have specifications that can handle applications that require extremely high levels of reliability, such as life-support systems, aircraft's control systems, or other applications whose failure can be reasonably expected to result in serious physical and/or material damage. Consult with your SANYO representative nearest you before using any SANYO products described or contained herein in such applications.

■ SANYO assumes no responsibility for equipment failures that result from using products at values that exceed, even momentarily, rated values (such as maximum ratings, operating condition ranges, or other parameters) listed in products specifications of any and all SANYO products described or contained herein.

SANYO Electric Co., Ltd. Semiconductor Company

TOKYO OFFICE Tokyo Bldg., 1-10, 1 Chome, Ueno, Taito-ku, TOKYO, 110-8534 JAPAN

Specifications

Maximum Ratings at $T_a = 25^\circ\text{C}$

Parameter	Symbol	Conditions	Ratings	Unit
Maximum Supply Voltage	$V_{6\text{max}}$		14.4	V
Maximum Control Signal Voltage	$V_{4\text{max}}$ $V_{6\text{max}}$ $V_{10\text{max}}$		14.4	V
Allowable Power Dissipation	$P_{d\text{max}}$	$T_a \leq 70^\circ\text{C}$	700	mW
Operating Temperature	T_{opr}		-20 to +70	$^\circ\text{C}$
Storage Temperature	T_{stg}		-55 to +125	$^\circ\text{C}$

Operating Conditions at $T_a = 25^\circ\text{C}$

Parameter	Symbol	Conditions	Ratings	Unit
Recommended Supply Voltage	V_{CC}		12	V
Operating Supply Voltage Range	$V_{CC\text{op}}$		8 to 13.2	Vs

Operating Characteristics at $T_a = 25^\circ\text{C}$, $V_{CC} = 12\text{V}$

Parameter	Symbol	Conditions	Ratings			Unit
			min	typ	max	
Quiescent Current	I_{CC}		35	43	57	mA
Video Input Bias Voltage	V_1, V_3, V_7		4.4	4.7	5.0	V
Video Output Bias Voltage	V_5, V_9		6.2	6.8	7.4	V
Video Input Impedance	Z_1, Z_3, Z_7	$f = 1\text{ kHz}$	15	21	27	$\text{k}\Omega$
Video Output Impedance	Z_5, Z_9	$f = 1\text{ kHz}$		42		Ω
Video Voltage Gain	G_{VV}	$V_{in} = 1\text{ V}_{p-p}$ (sine wave), $f = 0.1\text{ MHz}$	5.6	6.1	6.6	dB
Video Frequency Bandwidth	BW_V	$V_{in} = 0.7\text{ V}_{p-p}$ (sine wave), -3 dB band for 0.1 MHz	10			MHz
Output Noise Voltage	V_{nV}	$R_g = 75\ \Omega$, 10 MHz band		0.3	1.0	mVrms
Video Crosstalk (between inputs 1 and 2)	CT_{V1}	$R_g = 75\ \Omega$, $f = 3.58\text{ MHz}$	45	50		dB
Video Crosstalk (between inputs 1/2 and 3)	CT_{V2}	$R_g = 75\ \Omega$, $f = 3.58\text{ MHz}$	45	50		dB
Video Output Hum Rejection	HR_V	$f = 50\text{ Hz}$, $R_g = 75\ \Omega$	18	23		dB
Audio Input Bias Voltage	$V_{12}, V_{13},$ $V_{14}, V_{17},$ V_{18}, V_{19}		4.5	5.1	5.7	V
Audio Output Bias Voltage	$V_{11}, V_{15},$ V_{18}, V_{20}		3.2	3.8	4.4	V
Audio Input Impedance (inputs 1 and 2)	$Z_{12}, Z_{13},$ Z_{15}, Z_{19}	$f = 1\text{ kHz}$	47	68	88	$\text{k}\Omega$
Audio Input Impedance (input 3)	Z_{14}, Z_{17}	$f = 1\text{ kHz}$	51	74	95	$\text{k}\Omega$
Audio Output Impedance	$Z_{11}, Z_{15},$ Z_{16}, Z_{20}			75		Ω
Audio Voltage Gain	G_{VA}	$f = 1\text{ kHz}$, $V_{in} = 500\text{ mVrms}$	-0.5	-0.02	+0.5	dB
Audio Frequency Bandwidth	BW_A	-1 dB band ($V_{in} = 500\text{ mVrms}$) for $f = 1\text{ kHz}$ gain	100			kHz
Total Harmonic Distortion	THD	$f = 1\text{ kHz}$, $V_{in} = 500\text{ mVrms}$		0.03	0.2	%
Output Noise Voltage	V_{nA}	$R_g = 600\ \Omega$, 20 Hz to 20 kHz bandwidth		10	50	μVrms
Audio Crosstalk (between inputs 1 and 2)	CT_{A1}	$R_g = \text{less than } 4.7\ \text{k}\Omega$, $f = 1\text{ kHz}$ ($V_{in} = 500\text{ mVrms}$)	75	90		dB
Audio Crosstalk (between inputs 1/2 and 3)	CT_{A2}	$R_g = \text{less than } 4.7\ \text{k}\Omega$, $f = 1\text{ kHz}$ ($V_{in} = 500\text{ mVrms}$)	75	90		dB
Audio Crosstalk (between L and R channels)	CT_{AS}	$R_g = 4.7\ \text{k}\Omega$, $f = 1\text{ kHz}$ ($V_{in} = 500\text{ mVrms}$)	72	82		dB
Mute Noise	V_{OAM}	$f = 1\text{ kHz}$, $V_{in} = 500\text{ mVrms}$		0.02	0.1	mVrms
Audio Hum Rejection 1	HR1	Input $R_g = 4.7\ \text{k}\Omega$	40	46		dB
Audio Hum Rejection 2	HR2	Input open	28	39		dB
Switching Control Signal Input High Threshold Voltage	V_{4TH}, V_{8TH}		1.1	1.4	1.7	V
Switching Control Signal Input Leak Current	I_{4L}, I_{8L}				-3	μA
Mute Input High Threshold Voltage	V_{10TH}		1.1	1.4	1.7	V
Mute Input Leak Current	I_{10L}				-3	μA

Note: The current flowing to the IC is positive and current from the IC is negative.

Equivalent Circuit Block Diagram

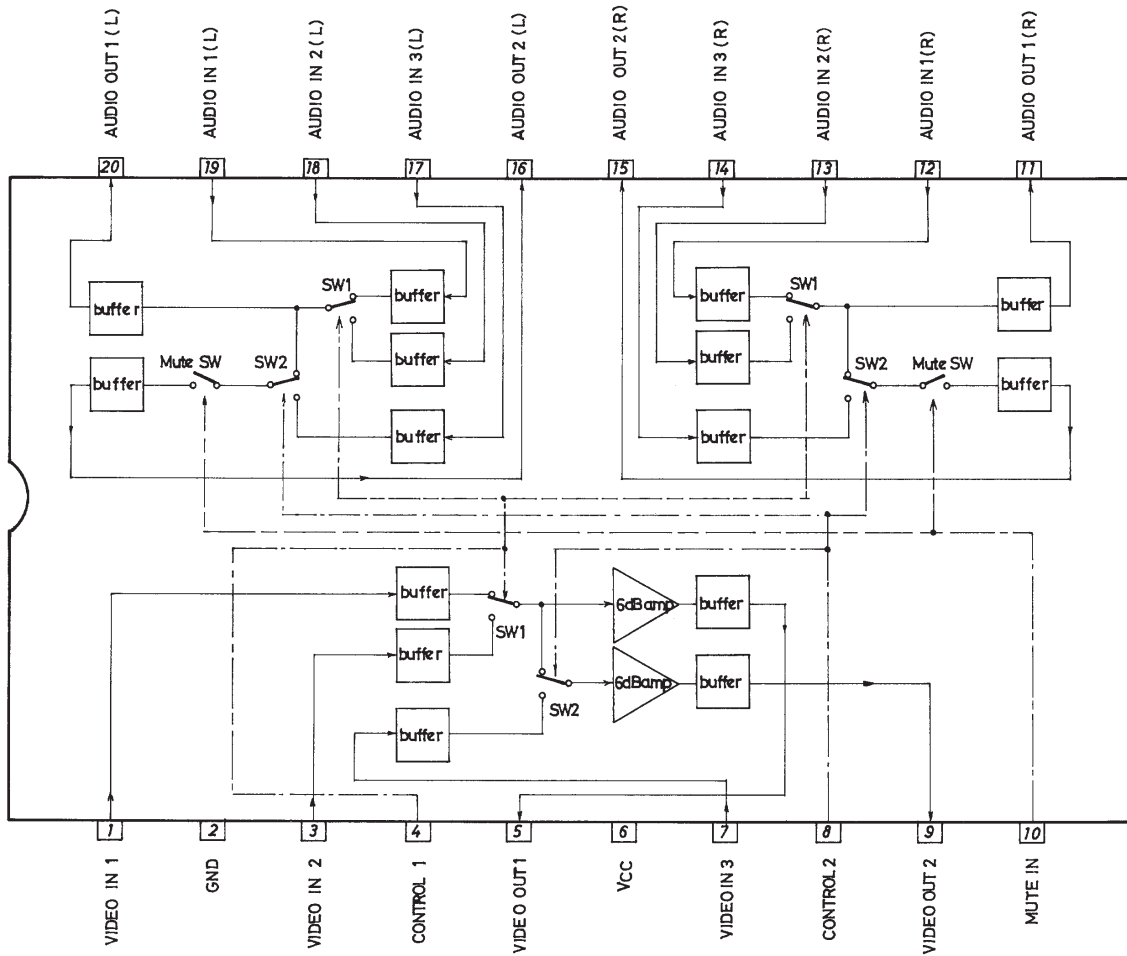

Switching Truth Table

CONTROL 1 (PIN 4)	CONTROL 2 (PIN 8)	MUTE IN (PIN10)	VIDEO OUT		AUDIO OUT			
			1	2	1 L	2 L	1 R	2 R
L	L	L	IN 1	IN 1	IN 1	IN 1	IN 1	IN 1
L	H	L	IN 1	IN 3	IN 1	IN 3	IN 1	IN 3
H	L	L	IN 2	IN 2	IN 2	IN 2	IN 2	IN 2
H	H	L	IN 2	IN 3	IN 2	IN 3	IN 2	IN 3
L	L	H	IN 1	IN 1	IN 1	—	IN 1	—
L	H	H	IN 1	IN 3	IN 1	—	IN 1	—
H	L	H	IN 2	IN 2	IN 2	—	IN 2	—
H	H	H	IN 2	IN 3	IN 2	—	IN 2	—

Pin Assignments

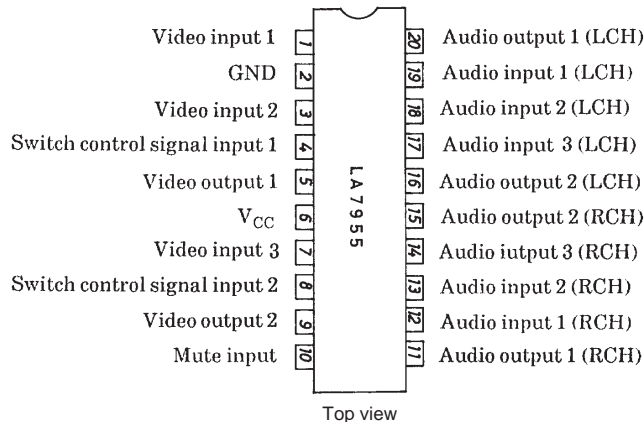

Sample Application Circuit

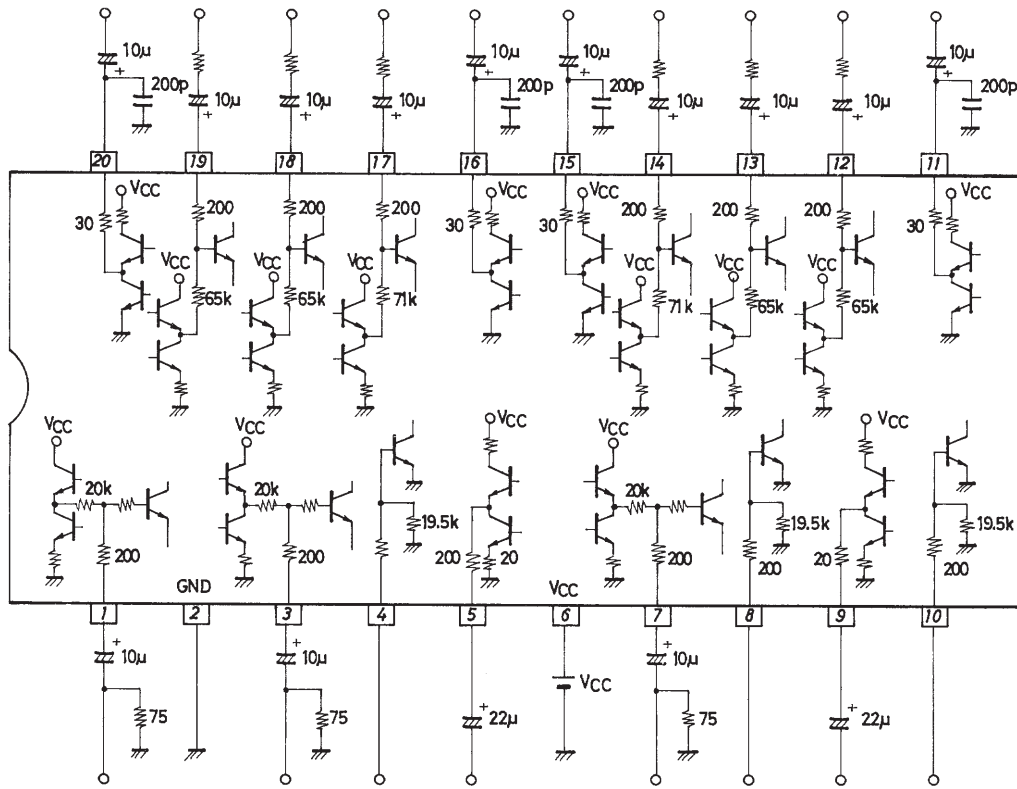

Unit (resistance:Ω, capacitance:F)

Circuit and Operational Description

1. Video Input circuit

The video input circuit shown in the figure on the right has an input impedance of approximately 20 kΩ. The input bias voltage is determined by the bias at point (A), however, the voltage at this point fluctuates according to V_{CC}.

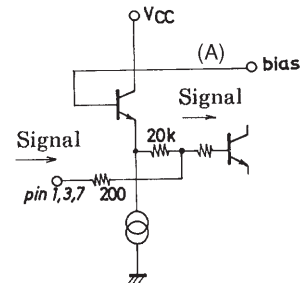

Unit (resistance:Ω)

2. Audio input circuit

The audio input circuit is shown in the figure on the right. The impedance of audio inputs 1 and 2 (Pins 12, 13, 18, and 19) is approximately 65 kΩ, and that of audio input 3 (Pins 14 and 17), approximately 71 kΩ. Although the input bias voltage is determined by the bias at point (B), the voltage at point (B) is supplied from a low-noise Zener diode voltage regulator circuit and is not dependent on V_{CC}.

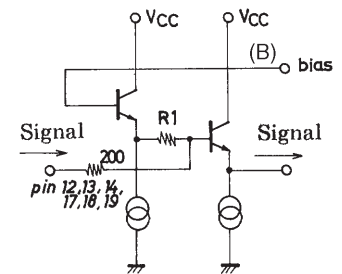

Unit (resistance:Ω)

3. Control signal input circuit

The circuit at input pins for the switching and muting circuits are shown in the figure on the right. The threshold voltage is approximately 1.4 V.

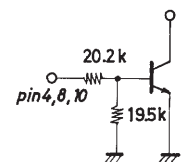

Unit (resistance:Ω)

4. Video Output Circuit

The video output is emitter follower output.

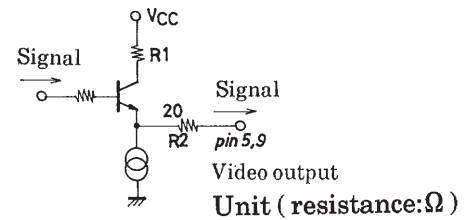

5. Audio output circuit

The audio output is emitter follower output.

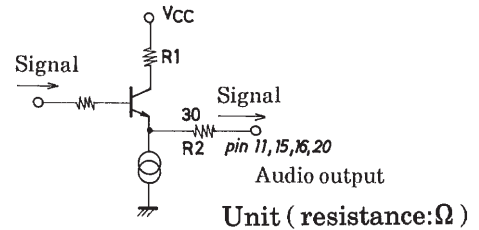

6. Video switch operation

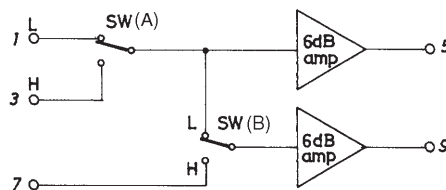

SW (A) is switched by the voltage of switching control input signal 1 (Pin 4), and SW (B), by the voltage of Switching control input signal 2 (Pin 8). In addition, there are amplifiers (with 75 Ω terminating output pins) with a gain of 6 dB at the pre-output stages of Pins 5 and 9. However, an external buffer is required when shorted with a 75 Ω resistor.

7. Audio switch operation

SW (A) is switched by the voltage of switching control input signal 1 (Pin 4), and SW (B), by the voltage of switching control input signal 2 (Pin 8). Setting the must input voltage (Pin 10) to H turns the muting switch ON and cutting output 2.

Two pairs of audio switches are built in, allowing use in equipment designs for multiplex broadcast systems.

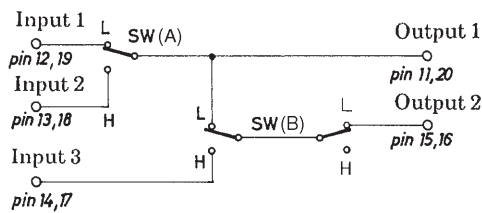

- Application Example 1 (TV with two video inputs)

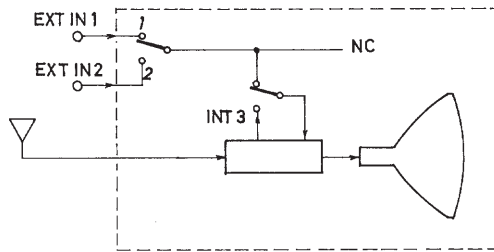

- Application Example 2 (TV with video inputs and VCR)

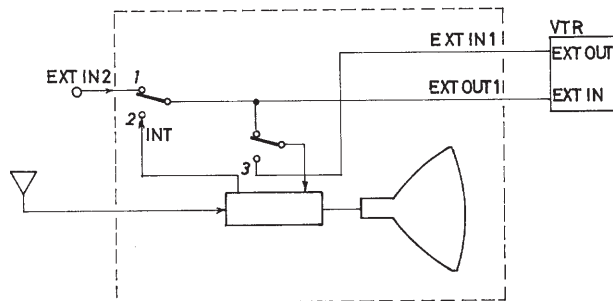

※ Audio output 2 is ideal for TV outputs as it has a built-in muting switch.

- Specifications of any and all SANYO products described or contained herein stipulate the performance, characteristics, and functions of the described products in the independent state, and are not guarantees of the performance, characteristics, and functions of the described products as mounted in the customer's products or equipment. To verify symptoms and states that cannot be evaluated in an independent device, the customer should always evaluate and test devices mounted in the customer's products or equipment.
- SANYO Electric Co., Ltd. strives to supply high-quality high-reliability products. However, any and all semiconductor products fail with some probability. It is possible that these probabilistic failures could give rise to accidents or events that could endanger human lives, that could give rise to smoke or fire, or that could cause damage to other property. When designing equipment, adopt safety measures so that these kinds of accidents or events cannot occur. Such measures include but are not limited to protective circuits and error prevention circuits for safe design, redundant design, and structural design.
- In the event that any or all SANYO products (including technical data, services) described or contained herein are controlled under any of applicable local export control laws and regulations, such products must not be exported without obtaining the export license from the authorities concerned in accordance with the above law.
- No part of this publication may be reproduced or transmitted in any form or by any means, electronic or mechanical, including photocopying and recording, or any information storage or retrieval system, or otherwise, without the prior written permission of SANYO Electric Co., Ltd.
- Any and all information described or contained herein are subject to change without notice due to product/technology improvement, etc. When designing equipment, refer to the "Delivery Specification" for the SANYO product that you intend to use.
- Information (including circuit diagrams and circuit parameters) herein is for example only; it is not guaranteed for volume production. SANYO believes information herein is accurate and reliable, but no guarantees are made or implied regarding its use or any infringements of intellectual property rights or other rights of third parties.

This catalog provides information as of December, 1999. Specifications and information herein are subject to change without notice.