

Features

- Ultra low leakage: nA level
- Operating voltage: 18V
- Low clamping voltage
- Complies with following standards:
 - IEC 61000-4-2 (ESD) immunity test
 - Air discharge: $\pm 15\text{kV}$
 - Contact discharge: $\pm 8\text{kV}$
 - IEC61000-4-4 (EFT) 40A (5/50ns)
- RoHS Compliant

Dimensions SOT-23

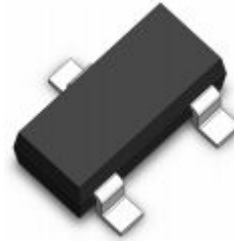

Pin Configuration

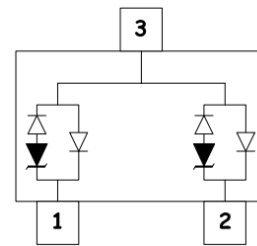

Applications

- USB 2.0 power and data line
- Set-top box and digital TV
- Digital video interface (DVI)
- Notebook Computers
- SIM Ports
- 10/100 Ethernet

Mechanical Characteristics

- Package: SOT-23
- Lead Finish: Lead Free
- UL Flammability Classification Rating 94V-0
- Quantity Per Reel: 3,000pcs
- Reel Size: 7inch

Absolute Maximum Ratings (Tamb=25°C unless otherwise specified)

Parameter	Symbol	Value	Unit
Peak Pulse Power (8/20 μs)	Ppp	300	W
ESD per IEC 61000-4-2 (Air)	V _{ESD}	± 15	Kv
ESD per IEC 61000-4-2 (Contact)		± 8	
Operating Temperature Range	T _J	-55 to +125	°C
Storage Temperature Range	T _{STJ}	-55 to +150	°C

Electrical Characteristics (TA=25°C unless otherwise specified)

Part Number	Device Marking	V _{RWM} (V)	V _{BR} (V)	I _T (mA)	V _C @1A	V _C		I _R μA (Max)	C (Pf) (Typ.)
						(Max)	(@A)		
LCD18DT3	KWD	18	19.7	1	27	45	4	1	1.5

Characteristic Curves

Fig1. 8/20μs Pulse Waveform

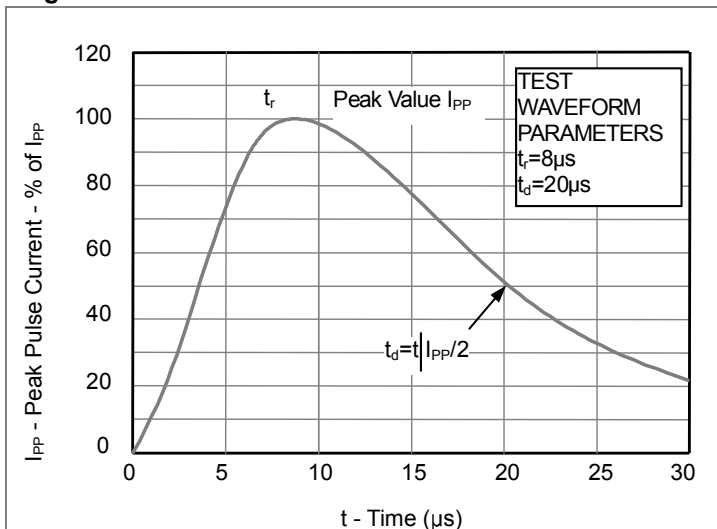

Fig2. ESD Pulse Waveform (according to IEC 61000-4-2)

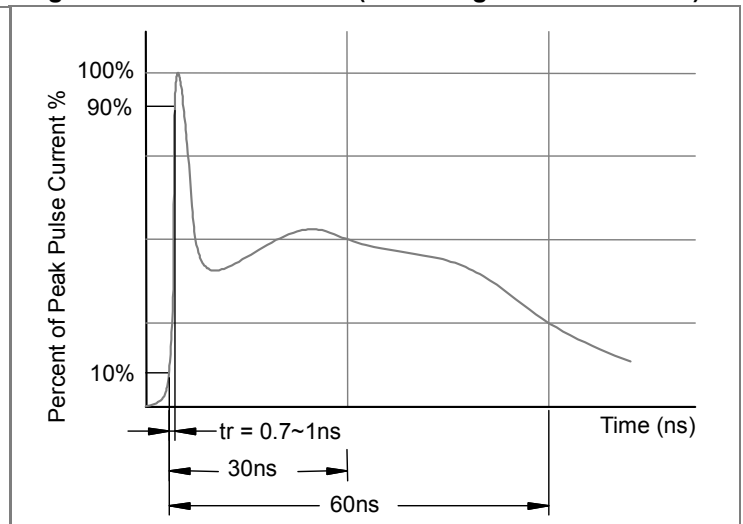
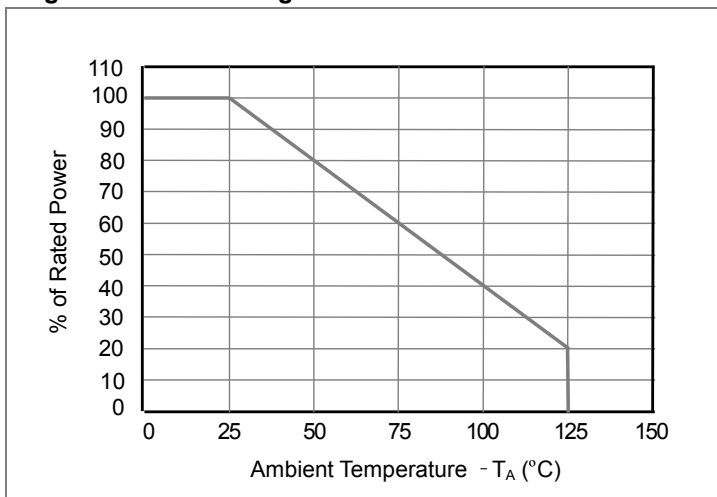
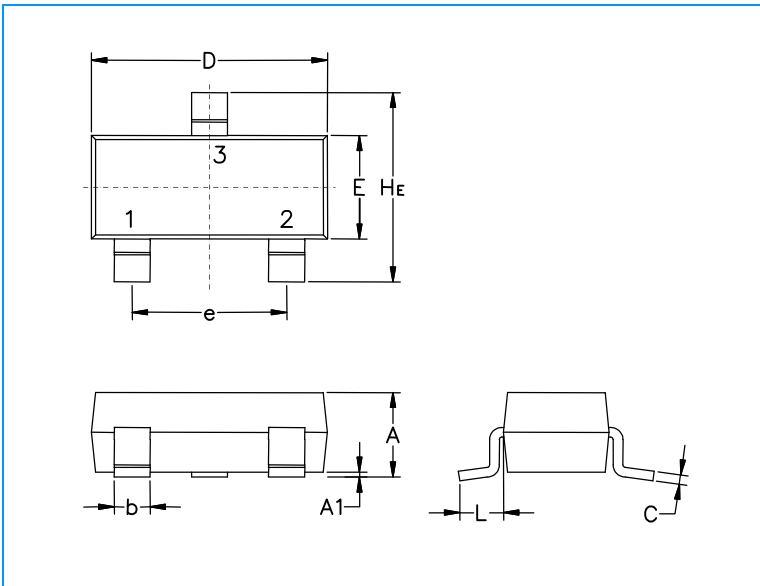

Fig3. Power Derating Curve



SOT-23 Package Outline & Dimensions



Symbol	Millimeters			Inches		
	Min.	Nom.	Max.	Min.	Nom.	Max.
A	0.89	1.00	1.11	0.035	0.040	0.044
A1	0.01	0.06	0.10	0.001	0.002	0.004
b	0.37	0.44	0.50	0.15	0.18	0.020
c	0.09	0.13	0.18	0.003	0.005	0.007
D	2.80	2.90	3.04	0.110	0.114	0.120
E	1.20	1.30	1.40	0.047	0.051	0.055
e	1.78	1.90	2.04	0.070	0.075	0.081
L	0.35	0.54	0.69	0.014	0.021	0.029
H _E	2.10	2.40	2.64	0.083	0.094	0.104

Soldering Footprint

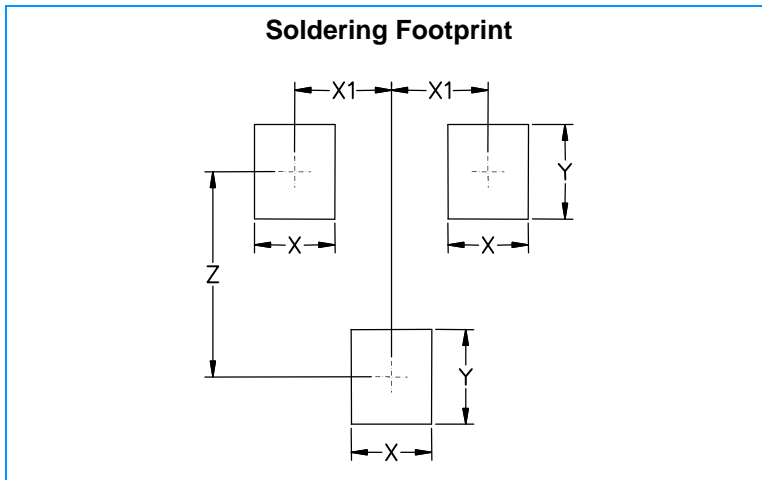

Symbol	Millimeters	Inches
X	0.80	0.031
X1	0.95	0.037
Y	0.90	0.035
Z	2.00	0.079