

LH532048

CMOS 2M (128K × 16) MROM

FEATURES

- 131,072 words × 16 bit organization
- Access time: 100 ns (MAX.)
- Static operation
- TTL compatible I/O
- Three-state outputs
- Single +5 V power supply
- Power consumption:
 - Operating: 412.5 mW (MAX.)
 - Standby: 550 μW (MAX.)
- Packages:
 - 40-pin, 600-mil DIP
 - 40-pin, 525-mil SOP
 - 44-pin, 650-mil QFJ (PLCC)

DESCRIPTION

The LH532048 is a 2M-bit mask-programmable ROM organized as 131,072 × 16 bits. It is fabricated using silicon-gate CMOS process technology.

PIN CONNECTIONS

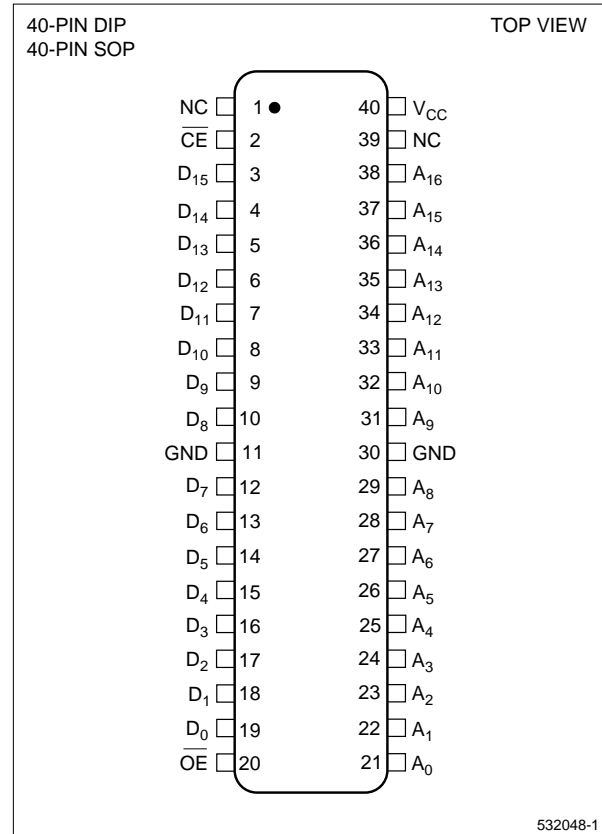

Figure 1. Pin Connections for DIP and SOP Packages

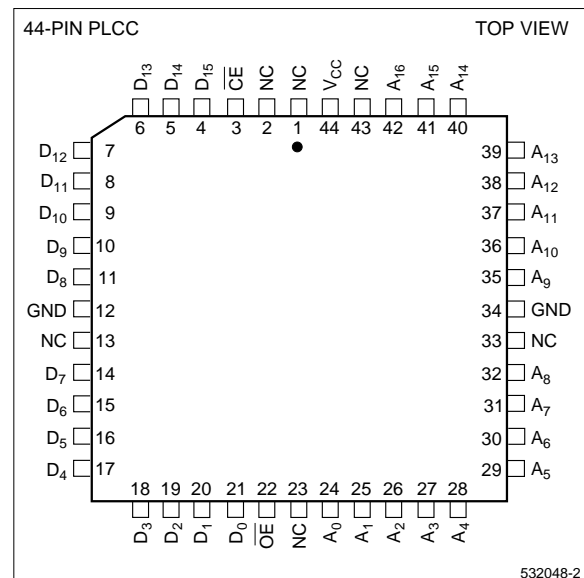

Figure 2. Pin Connections for QFJ (PLCC) Package

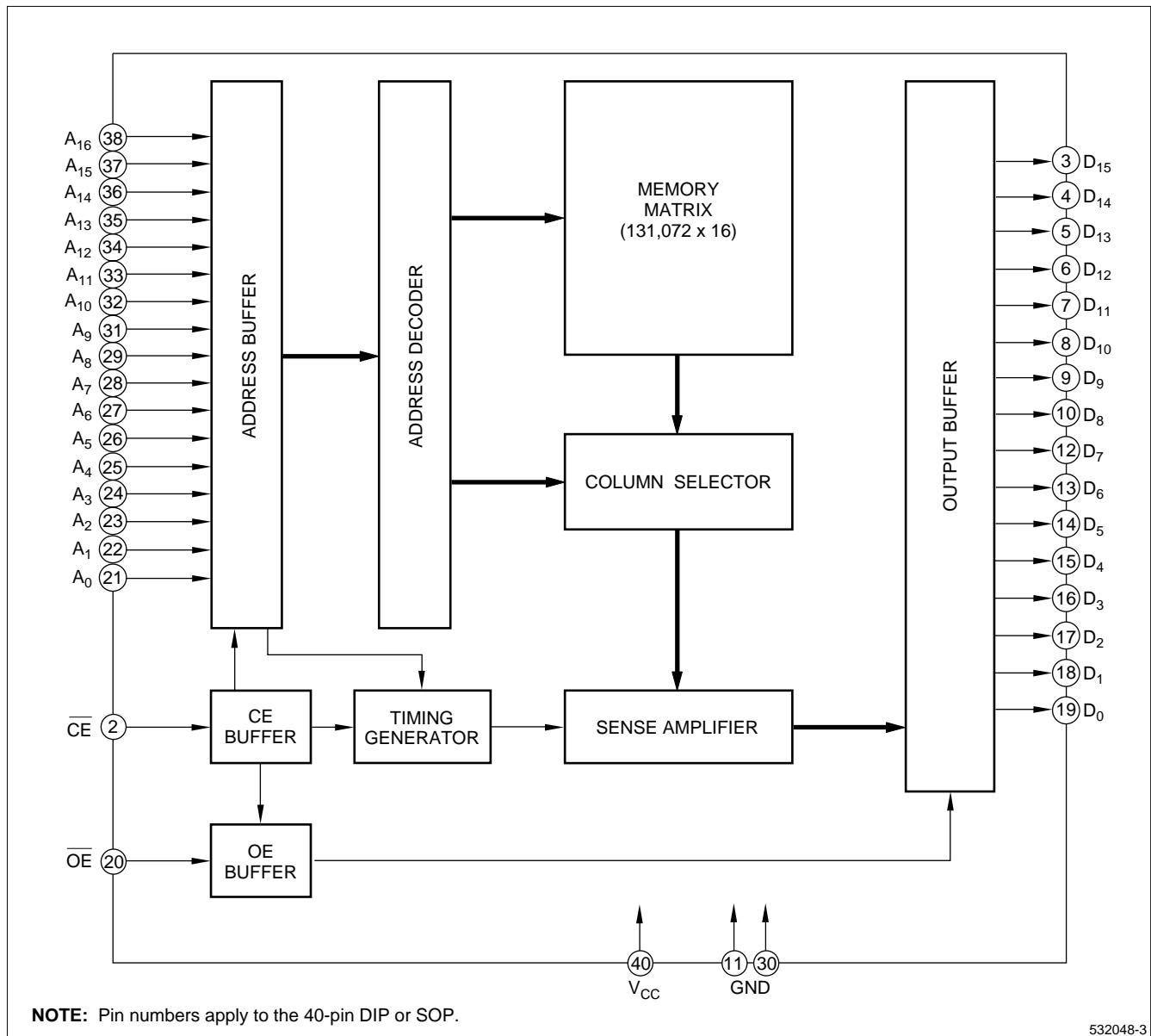

Figure 3. LH532048 Block Diagram

PIN DESCRIPTION

SIGNAL	PIN NAME
A ₀ – A ₁₆	Address input
D ₀ – D ₁₅	Data output
CE	Chip enable input
OE	Output enable input

SIGNAL	PIN NAME
V _{CC}	Power supply (+5 V)
GND	Ground
NC	No connection

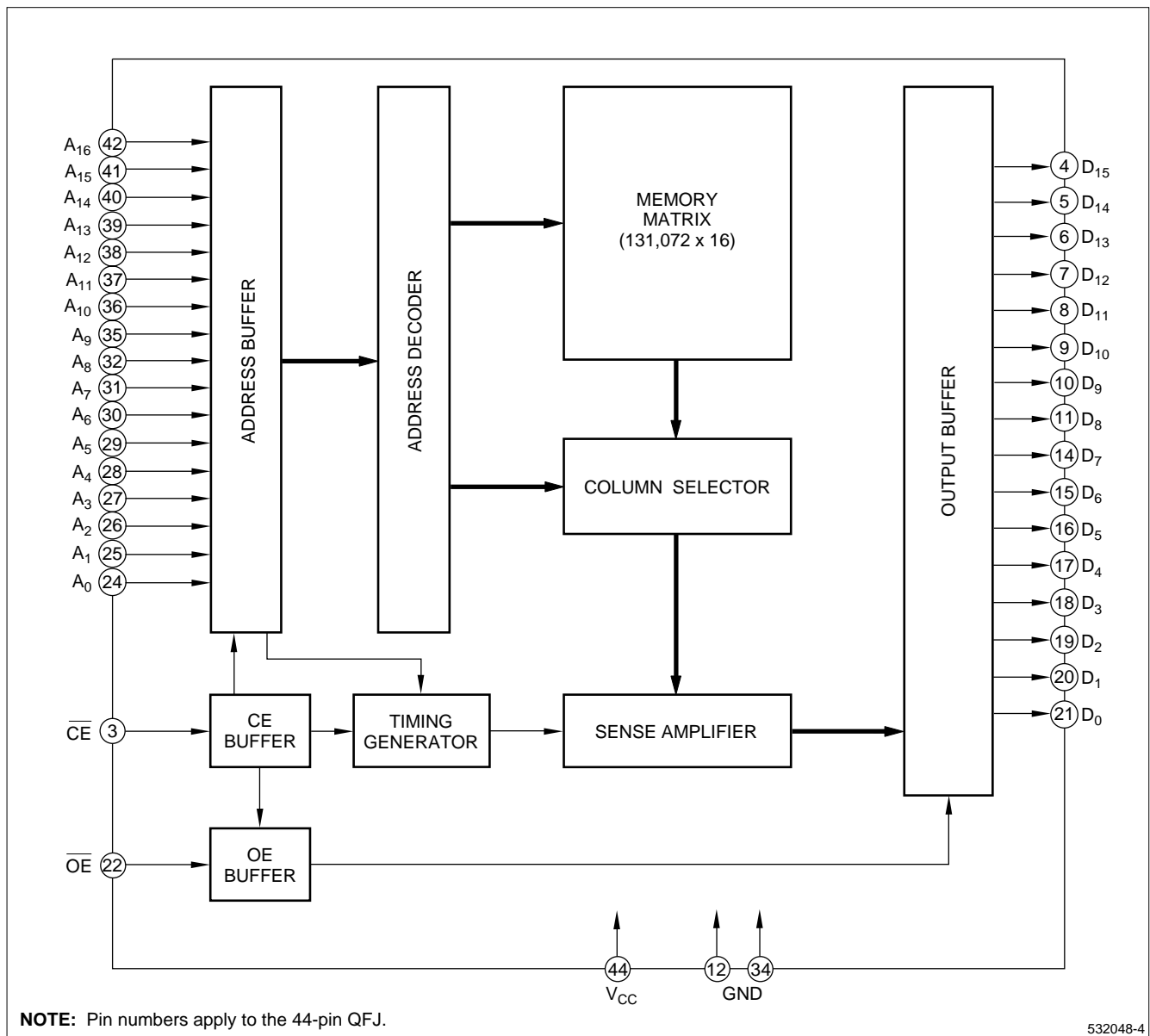

Figure 4. LH532048 Block Diagram

TRUTH TABLE

\overline{CE}	\overline{OE}	DATA OUTPUT	SUPPLY CURRENT
H	X	High-Z	Standby
L	H	High-Z	Operating
L	L	D ₀ – D ₁₅	Operating

NOTE:

X = H or L, High-Z = High-impedance

ABSOLUTE MAXIMUM RATINGS

PARAMETER	SYMBOL	RATING	UNIT
Supply voltage	V _{CC}	-0.3 to +7.0	V
Input voltage	V _{IN}	-0.3 to V _{CC} + 0.3	V
Output voltage	V _{OUT}	-0.3 to V _{CC} + 0.3	V
Operating temperature	T _{opr}	0 to +70	°C
Storage temperature	T _{stg}	-65 to +150	°C

RECOMMENDED OPERATING CONDITIONS (T_A = 0°C to +70°C)

PARAMETER	SYMBOL	MIN.	TYP.	MAX.	UNIT
Supply voltage	V _{CC}	4.5	5.0	5.5	V

DC CHARACTERISTICS (V_{CC} = 5 V ±10%, T_A = 0°C to +70°C)

PARAMETER	SYMBOL	CONDITIONS	MIN.	MAX.	UNIT	NOTE
Input 'High' voltage	V _{IH}		2.2	V _{CC} + 0.3	V	
Input 'Low' voltage	V _{IL}		-0.3	0.8	V	
Output 'High' voltage	V _{OH}	I _{OH} = -400 μA	2.4		V	
Output 'Low' voltage	V _{OL}	I _{OL} = 2.0 mA		0.4	V	
Input leakage current	I _{LI}	V _{IN} = 0 V to V _{CC}		10	μA	
Output leakage current	I _{LO}	V _{OUT} = 0 V to V _{CC}		10	μA	1
Operating current	I _{CC1}	t _{RC} = 100 ns		75	mA	2
	I _{CC2}	t _{RC} = 1 μs		65	mA	2
	I _{CC3}	t _{RC} = 100 ns		70	mA	3
	I _{CC4}	t _{RC} = 1 μs		60	mA	3
Standby current	I _{SB1}	CE = V _{IH}		3	mA	
	I _{SB2}	CE = V _{CC} - 0.2 V		100	μA	
Input capacitance	C _{IN}	f = 1 MHz		10	pF	
Output capacitance	C _{OUT}	T _A = 25°C		10	pF	

NOTES:

1. CE/OE = V_{IH}
2. V_{IN} = V_{IH} or V_{IL}, CE = V_{IL}, outputs open
3. V_{IN} = (V_{CC} - 0.2 V) or 0.2 V, CE = 0.2 V, outputs open

AC CHARACTERISTICS ($V_{CC} = 5\text{ V} \pm 10\%$, $T_A = 0^\circ\text{C}$ to $+70^\circ\text{C}$)

PARAMETER	SYMBOL	MIN.	MAX.	UNIT	NOTE
Read cycle time	t_{RC}	100		ns	
Address access time	t_{AA}		100	ns	
Chip enable access time	t_{ACE}		100	ns	
Output enable delay time	t_{OE}		55	ns	
Output hold time	t_{OH}	0		ns	
CE to output in High-Z	t_{CHZ}		50	ns	1
OE to output in High-Z	t_{OHZ}			ns	

NOTE:

1. This is the time required for the outputs to become high-impedance.

AC TEST CONDITIONS

PARAMETER	RATING
Input voltage amplitude	0.4 V to 2.6 V
Input rise/fall time	10 ns
Input/output reference level	1.5 V
Output load condition	1 TTL + 100 pF

CAUTION

To stabilize the power supply, it is recommended that a high-frequency bypass capacitor be connected between the V_{CC} pin and the GND pin.

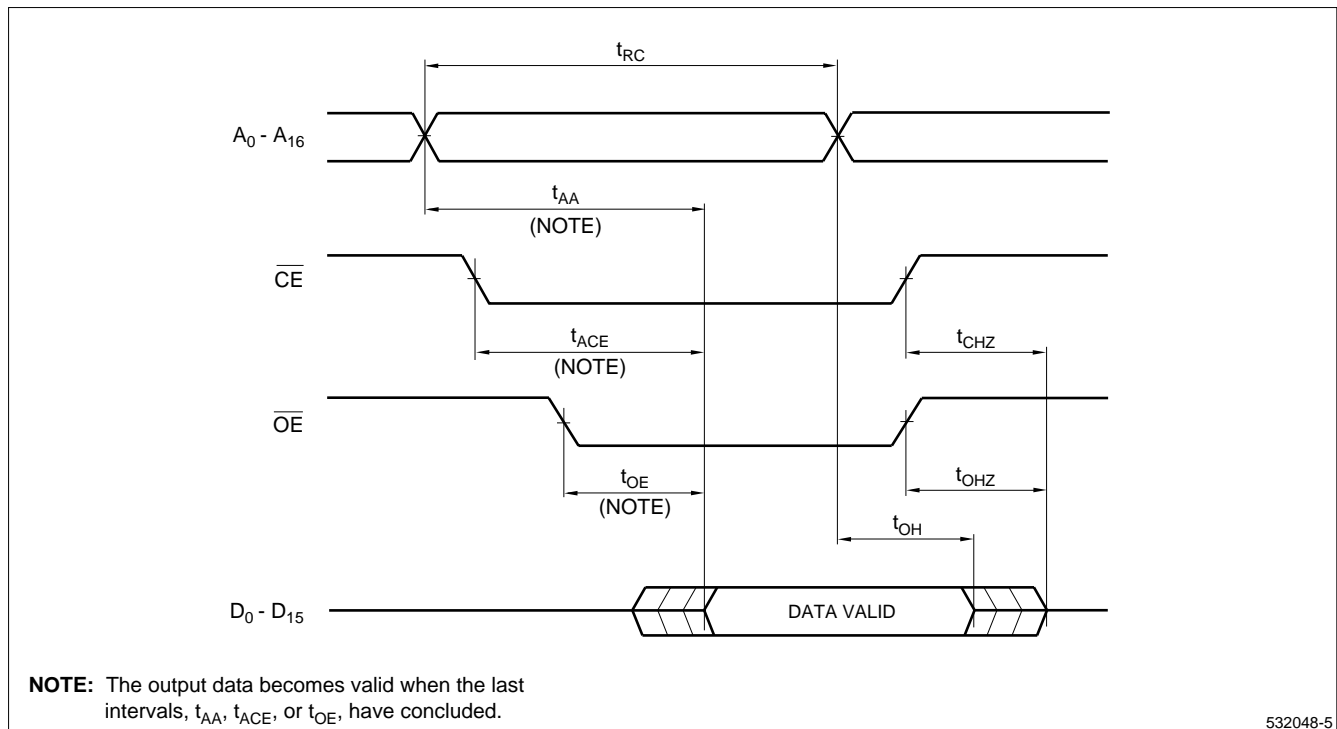
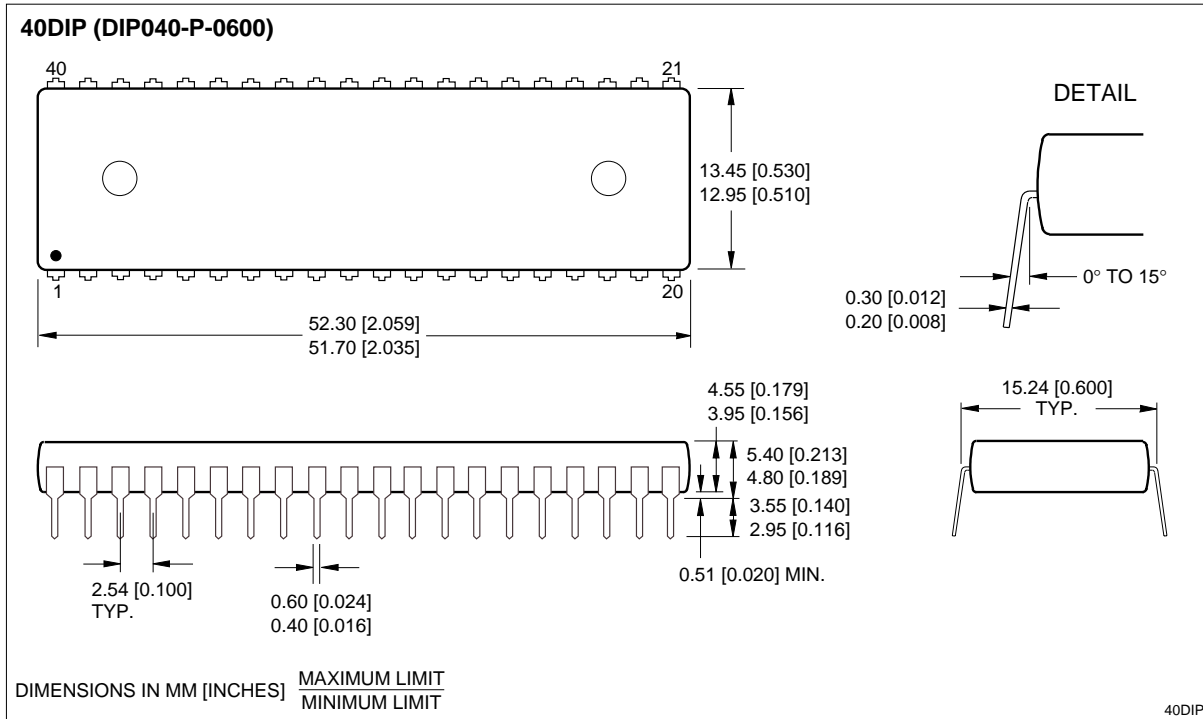
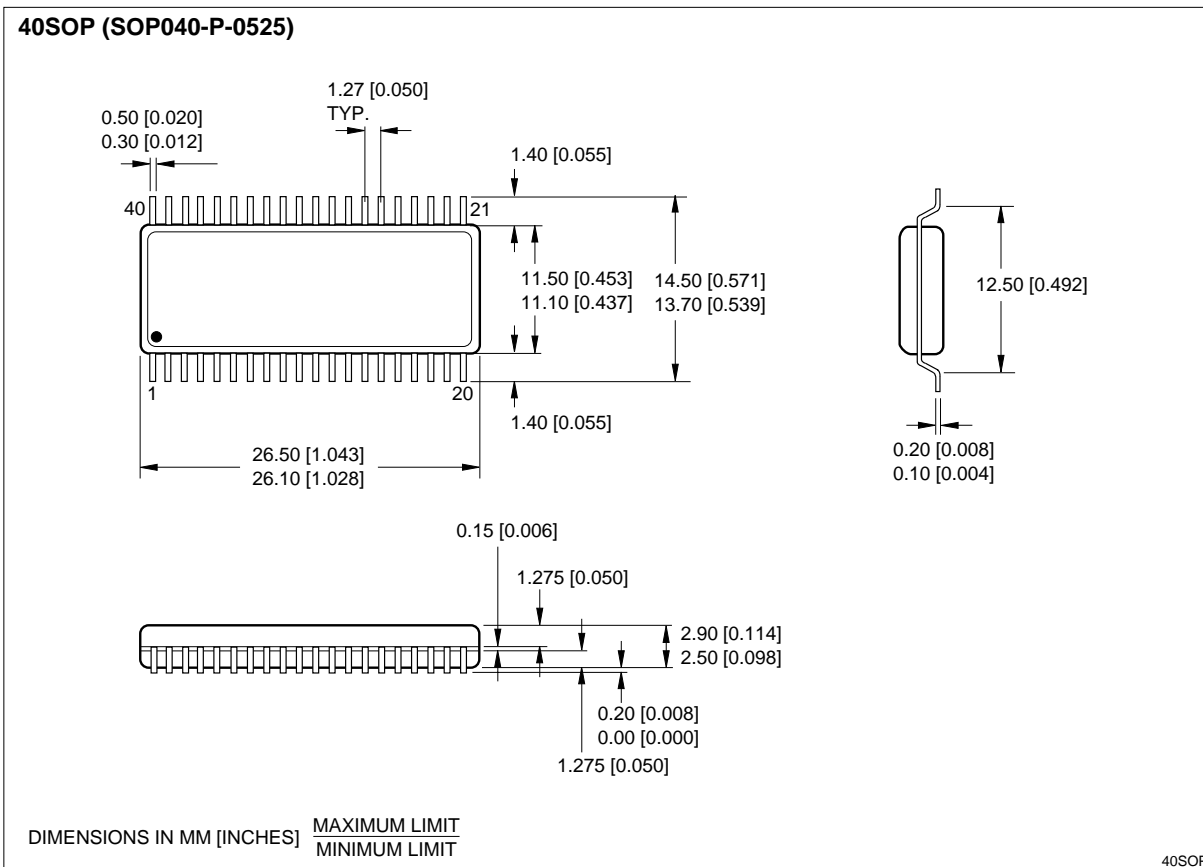

Figure 5. Timing Diagram

PACKAGE DIAGRAMS



40-pin, 600-mil DIP



40-pin, 525-mil SOP

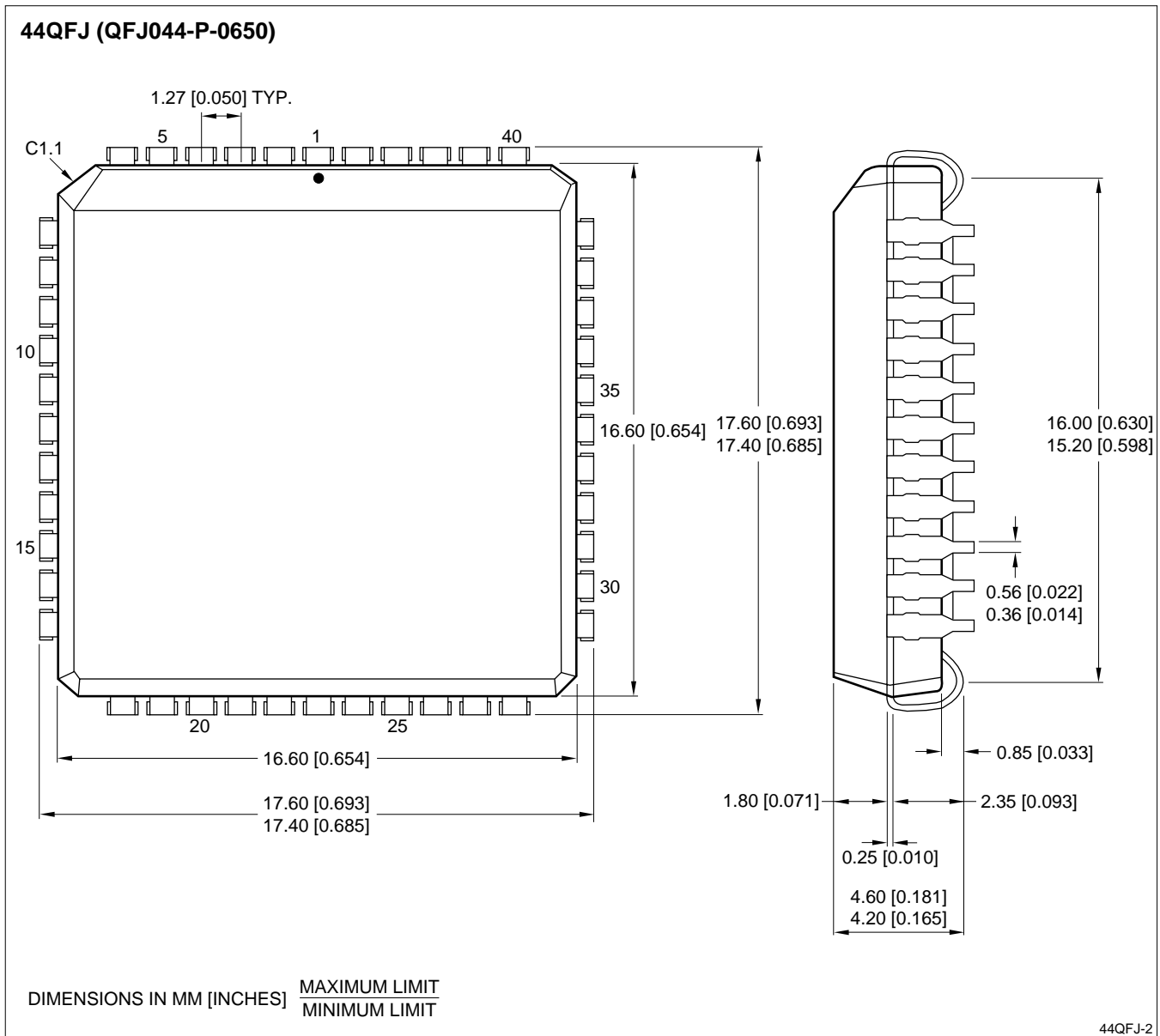

44-pin, 650-mil QFJ (PLCC)

ORDERING INFORMATION

