

LSP10 Module Series



Agency Approvals

Agency	Standard	Agency File Number
cULus	UL1449	E320116

Applications

- Outdoor and Commercial LED Lighting
- Roadway lighting
- Traffic lighting
- Digital signage
- Wash wall lighting
- Parking garage/lot lighting
- Flood lighting
- Tunnel lighting
- Street lighting

Additional Information



Datashet



Resources



Samples

Description

The Littelfuse LSP10 thermally protected Surge Protective Device is a self-protected device which is specially designed to be used in outdoor and commercial LED lighting fixtures for transient overvoltage protection. It is constructed with Littelfuse thermally protected varistor technology. Its built-in thermal disconnect function provides additional protection to prevent catastrophic failure and fire hazard even under the extreme circumstances of varistor end-of-life or sustaining over voltage conditions. LSP10 series connected option allows clear indication of thermal fault protection by disconnecting power to luminaire thereby signally SPD module replacement. The LSP10 SPD facilitates customer's product compliance to IEEE C62.41.2 Location Category C High and US Dept of Energy MSSLC Model Spec.

Features

- 20kA Maximum Discharge Current (Imax)m 8/20us
- Meets ANSI C82.77-5-2015: Location C High
- Meets ANSI C136.2-2015: Extreme Level
- Meets IEEE C62.41.2: Location Category C High
- Meets US Dept. of Energy MSSLC Model Spec.
- Parallel or Series connected options
- Thermally protected
- IP66 rated, dust-tight and water resistant
- IEC61643-11 Class II/ EN61643-11 Type 2 Compliant¹
- 240Vac and 277Vac parts are available for Class I and Class II installation based on IEC luminaire protection classes. Please see details in Part Numbering System.
- CE Mark - Meets the requirements of Low Voltage and RoHS European Directives.

Notes:

- Self-declared compliance.

Absolute Maximum Ratings

- For ratings of individual members of a series, see Device Ratings and Specifications chart

	LSP10 Series	Units
Continous:		
AC Voltage Range ($V_{M(AC/RMS)}$)	150 to 510	V
Continuous Current*	5	A
Transient:		
Maximum Discharge Current 8/20 μ s Waveform (Imax)	20,000	A
Nominal Discharge Current 8/20 μ s Waveform (I_n)	10,000	A
Operating Ambient Temperature Range (T_A)	-45 to +85	°C
Storage Temperature Range (T_{STG})	-45 to +110	°C
Isolation Voltage Capability (When the thermal disconnect opens)	600	V
Insulation Resistance	>1,000	M Ω

Note: * = Max. continuous current for series connection.

CAUTION: Stresses above those listed in "Absolute Maximum Ratings" may cause permanent damage to the device. This is a stress only rating and operation of the device at these or any other conditions above those indicated in the operational sections of this specification is not implied.

LSP10 Series Device Ratings & Specifications

Part Number ³	Operating Voltage (VAC)	MCOV/Uc (VAC) ⁶	Maximum Discharge Current (Imax)(A) ³	Nominal Discharge Current (In)(A) ²	MLV (V) ⁴	Up (V) ⁵	Safety Compliance	
							IEC/EN 61643-11 ⁷	UL1449
LSP10120*	120	150	20,000	10,000	L-N:740 L-G:740 N-G:670	900		X
LSP10240*	240	275	20,000	10,000	L-N:1130 L-G:1130 N-G:1060	1200	X	X
LSP10277*	277	320	20,000	10,000	L-N:1330 L-G:1330 N-G:1260	1400	X	X
LSP10347*	347	420	20,000	10,000	L-N:1750 L-G:1750 N-G:1680	1900		X
LSP10480*	480	510	20,000	10,000	L-N:2020 L-G:2020 N-G:1960	2100		X
LSP10240LL*	L-L:240	L-L:275	20,000	10,000	L-L:1130	L-L:1200		X
	L-N/G:120	L-N/G:150			L-N/G:740	L-N/G:900		X
LSP10480LL*	L-L:480	L-L:510	20,000	10,000	L-L:2020	L-L:2100		X
	L-N/G:277	L-N/G:320			L-N/G:1330	L-N/G:1400		X

- Notes:
- 5A max. continuous current for series connection.
 - Nominal Discharge Current (In)(A): The nominal discharge current is a measure of the SPDs endurance capability; 15 impulses of discharge current uses the 8/20us current waveform.
 - Maximum Discharge Current (Imax)(A): The maximum discharge current is a measure of the SPDs maximum capability; single impulse of discharge current uses the 8/20us current waveform. All Devices pass maximum discharge current with possible, safe opening of thermal disconnect.
 - MLV – UL1449 Measured limiting voltage; the highest value of residual voltage measurements during the application of impulses of 8/20us nominal discharge current (In); an average voltage value of 15 impulses.
 - Up – IEC 61643-11 Voltage protection level; the highest value of residual voltage measurements during the application of impulses of 8/20us nominal discharge current (In); a rounding voltage value of maximum measurement.
 - MCOV/UC: Maximum Continuous Operating Voltage - maximum r.m.s. voltage that could be continuously applied to the SPD.
 - The series modules can be used in parallel connections for the indication circuit connection.
 - * = - P or PM
 - Repetitive Surge Withstanding: 15 strikes at 10,000A (8/20us) with steady MLV/Up.

Repetitive Surge Capability for LSP10

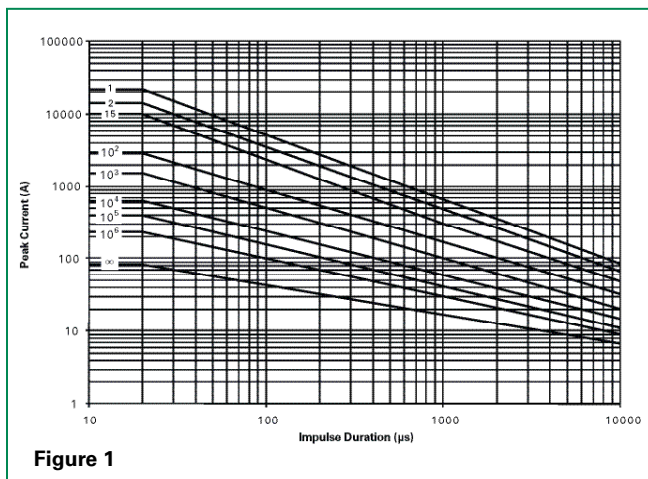

Pulse Rating (8x20µSec)	
Strikes	Surge
1	20,000A
2	15,000A
15	10,000A
100	3,000A
1,000	1,600A
10,000	650A
100,000	400A
1,000,000	240A

Dimensions

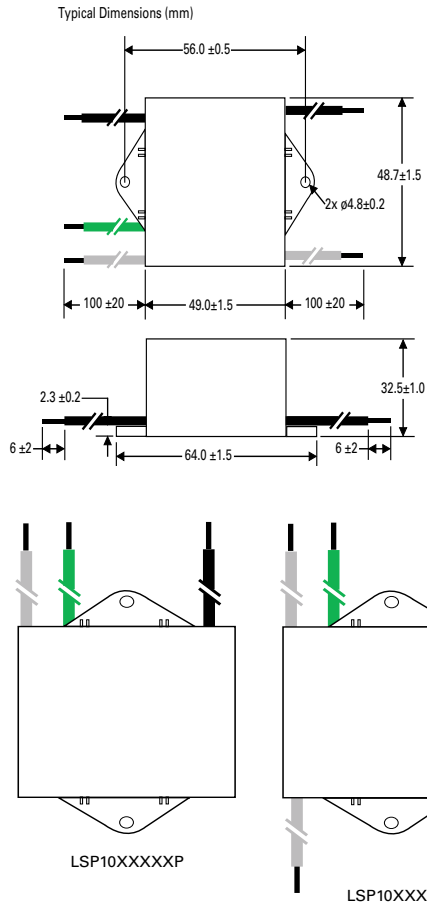

- Notes:
- Black: Line; White: Neutral; Green: Ground.
(P/N with suffix X3333/X3316: Brown: Line; Blue: Neutral; Green-Yellow stripe: Ground)
 - Wire Gauge: AWG16 wire Line in/out; Wire Length: 100mm or customized.

Part Numbering System

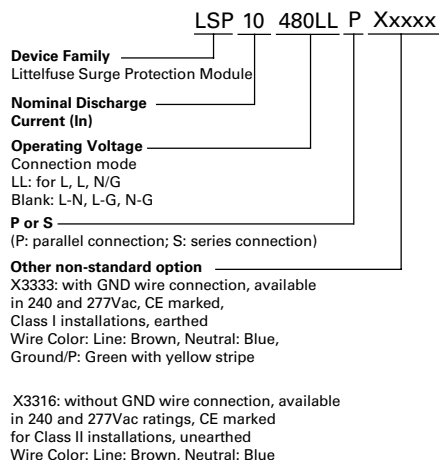

Application/Installation Schematic

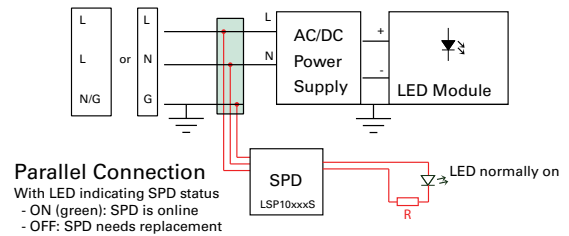
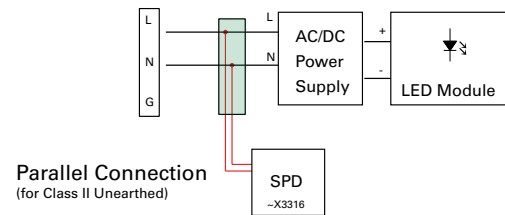
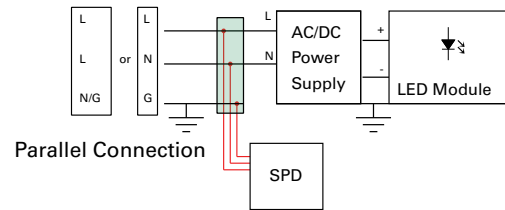

Notes:

- Series module used in parallel connection for indication circuit connection.
- LED indicator and associated circuitry are not included in the module.
- Black wire is AC line voltage (hot); white wire is AC neutral voltage.
- Black wire voltage is cut off when SPD needs replacement.
- R is current limiting resistor; its resistance/wattage is determined by AC line voltage and desired current driving LED. Example: AC line voltage 240V, LED: 1.6mA, resistor: 150Kohm/0.5W.

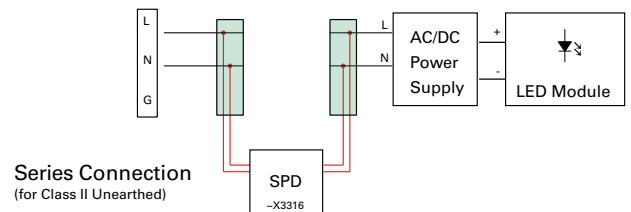
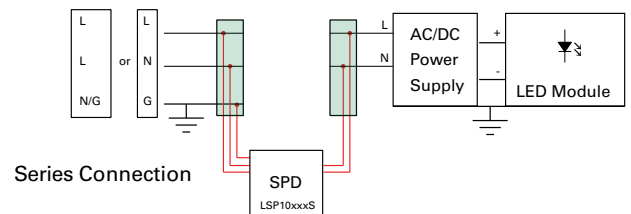

Disclaimer Notice - Information furnished is believed to be accurate and reliable. However, users should independently evaluate the suitability of and test each product selected for their own applications. Littelfuse products are not designed for, and may not be used in, all applications. Read complete Disclaimer Notice at <http://www.littelfuse.com/disclaimer-electronics>.