

# M63994P/FP

HIGH VOLTAGE HALF BRIDGE DRIVER

## DESCRIPTION

M63994P/FP is high voltage Power MOSFET and IGBT module driver for half bridge applications.

## FEATURES

- FLOATING SUPPLY VOLTAGE ..... 600V
- OUTPUT CURRENT ..... ±500mA
- SINGLE INPUT TYPE
- INTERNALLY SET DEADTIME
- HALF BRIDGE DRIVER
- UNDERVOLTAGE LOCKOUT
- 8 LEAD DIP/8 LEAD SOP

## APPLICATIONS

MOSFET and IGBT inverter module driver for refrigerator, air-conditioner, washing machine, AC-servomotor and general purpose.

## PIN CONFIGURATION (TOP VIEW)

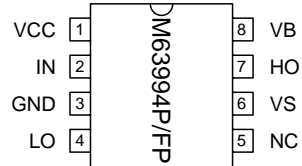

NC:NO CONNECTION

PACKAGE TYPE (8 Lead DIP/8 Lead SOP)

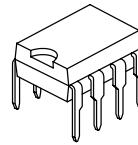

8P4

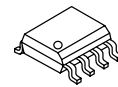

8P2S

## BLOCK DIAGRAM

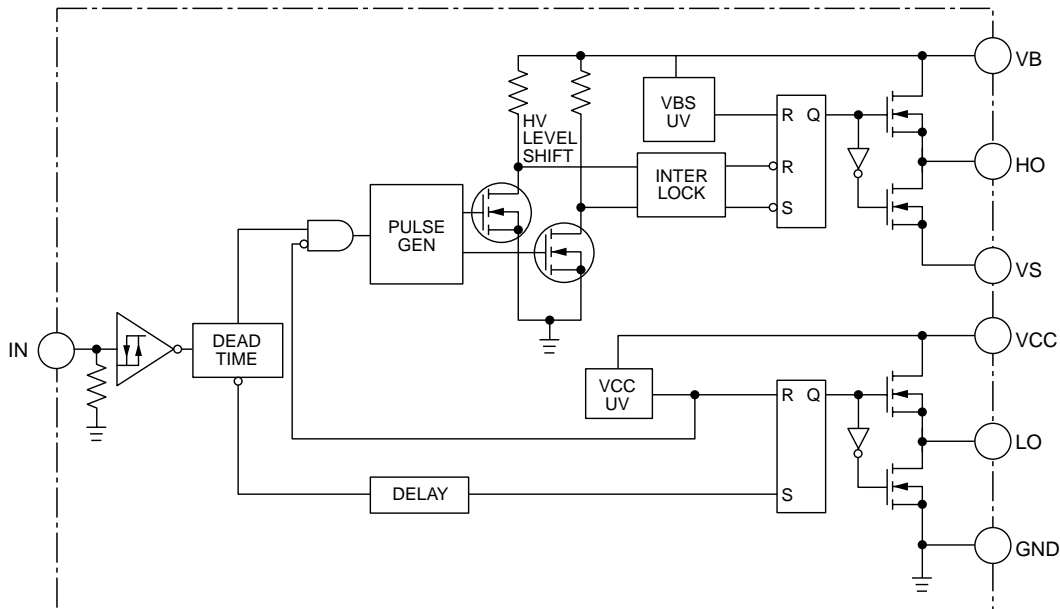

**ABSOLUTE MAXIMUM RATINGS**

Symbol	Parameter	Conditions	Ratings	Unit
VB	High Side Floating Supply Voltage		-0.5~624	V
VS	High Side Floating Supply Offset Voltage		VB-24 ~ VB+0.5	V
VHO	High Side Output Voltage		VS-0.5 ~ VB+0.5	V
VCC	Low Side Fixed Supply Voltage		-0.5 ~ 24	V
VLO	Low Side Output Voltage		VS ~ VCC+0.5	V
VIN	Logic Input Voltage		-0.5 ~ VCC+0.5	V
dVS/dt	Allowable Offset Supply Voltage Transient		±50	V/ns
Pt	Package Power Dissipation	On Board, Ta = 25°C	0.85(P)/0.6(FP)	W
K θ	Linear Derating Factor	On Board, Ta > 25°C	8.5(P)/6.0(FP)	mW/°C
Rth(j-c)	Junction-Case Thermal Resistance		40(P)/50(FP)	°C/W
Tj	Junction Temperature		-20 ~ +125	°C
Topr	Operation Temperature		-20 ~ +100	°C
Tstg	Storage Temperature		-40 ~ +125	°C

**RECOMMENDED OPERATING CONDITIONS**

Symbol	Parameter	Test Conditions	Limits			Unit
			Min.	Typ.	Max.	
VB	High Side Floating Supply Voltage		VS+13.5	—	VS+20	V
VS	High Side Floating Supply Offset Voltage		-5	—	500	V
VCC	Low Side Fixed Supply Voltage		13.5	—	20	V
VIN	Logic Input Voltage		0	—	VCC	V

**THERMAL DERATING FACTOR CHARACTERISTICS  
(ABSOLUTE MAXIMUM RATINGS)**

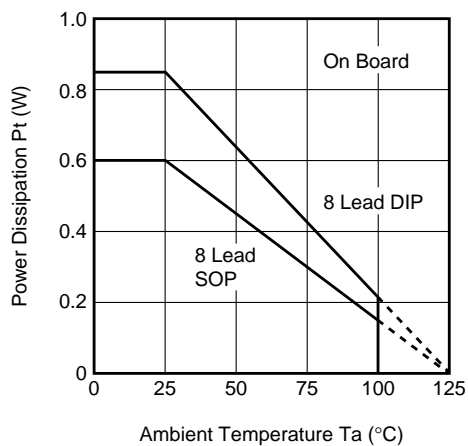

**ELECTRICAL CHARACTERISTICS (Ta=25°C, VCC=VBS(=VB-VS)=15V, unless otherwise specified)**

Symbol	Parameter	Test conditions	Limits			Unit
			Min.	Typ.	Max.	
IFS	Floating Supply Leakage Current	VB=VS=600V	—	—	1.0	μA
IBS	VBS standby Current		—	500	750	μA
ICC	VCC standby Current		—	500	750	μA
VINH	High Level Input Threshold Voltage		—	11	—	V
VINL	Low Level Input Threshold Voltage		—	6	—	V
VINHYS	Input Hysteresis Voltage		—	5.0	—	V
IINH	High Level Input Bias Current	VIN=15V	—	75	200	μA
IINL	Low Level Input Bias Current	VIN=0V	—	—	1.0	μA
VBSUVR	VBS Supply UV Reset Voltage		7.5	8.5	9.5	V
VBSUVT	VBS Supply UV Trip Voltage		7.0	8.0	9.0	V
tVBSUV	VBS Supply Filter Time		—	7.5	—	μs
VCCUVR	VCC Supply UV Reset Voltage		7.5	8.5	9.5	V
VCCUVT	VCC Supply UV Trip Voltage		7.0	8.0	9.0	V
tVCCUV	VCC Supply Filter Time		—	7.5	—	μs
VOH	High Level Output Voltage	IO=0A	13.8	14.4	—	V
VOL	Low Level Output voltage	IO=0A	—	—	0.1	V
IOH	Output High Level Short Circuit Pulsed Current	VO=0V, PW<10μs	—	-0.5	—	A
IOL	Output Low Level Short Circuit Pulsed Current	VO=15V, PW<10μs	—	0.5	—	A
ROH	Output High Level On Resistance	IO=200mA, ROH=(VOH-VO)/IO	—	40	—	Ω
ROL	Output Low Level On Resistance	IO=200mA, ROL=VO/IO	—	20	—	Ω
tDEAD	Deadtime LO Turn-off to HO Turn-on & HO Turn-off to LO Turn-on	CL=1000pF between LO(HO) – GND(VS)	0.50	0.75	1.00	μs
tdLH	Output Turn-On Propagation Delay	CL=1000pF between LO(HO) – GND(VS)	0.7	1.0	1.3	μs
tdHL	Output Turn-Off Propagation Delay	CL=1000pF between LO(HO) – GND(VS)	0.2	0.3	0.4	μs
tr	Output Turn-On Rise Time	CL=1000pF between LO(HO) – GND(VS)	—	75	180	ns
tf	Output Turn-On Fall Time	CL=1000pF between LO(HO) – GND(VS)	—	75	180	ns

**INPUT/OUTPUT TIMING DIAGRAM**

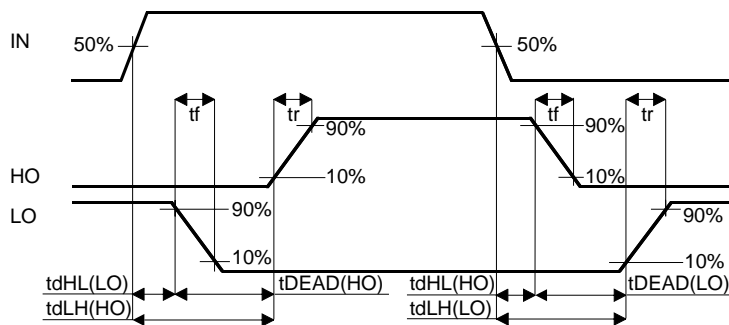

**PERFORMANCE CURVES**

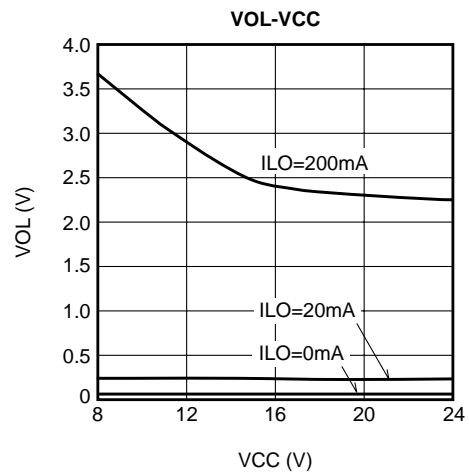
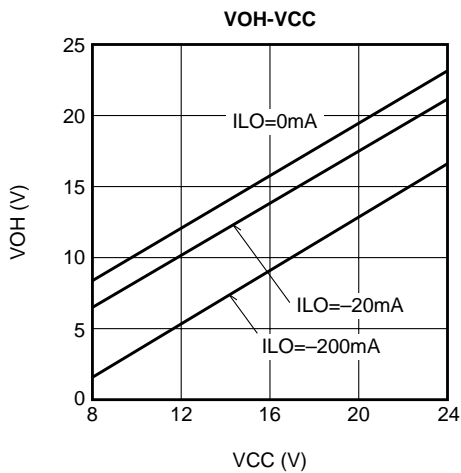
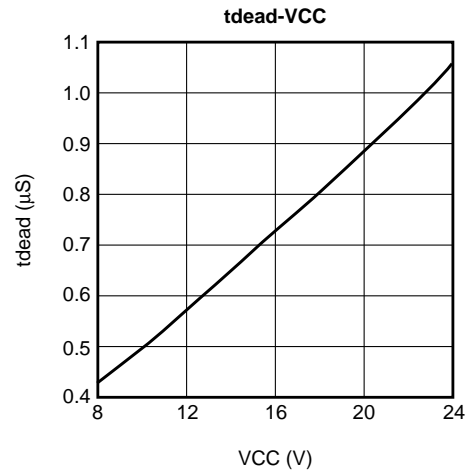
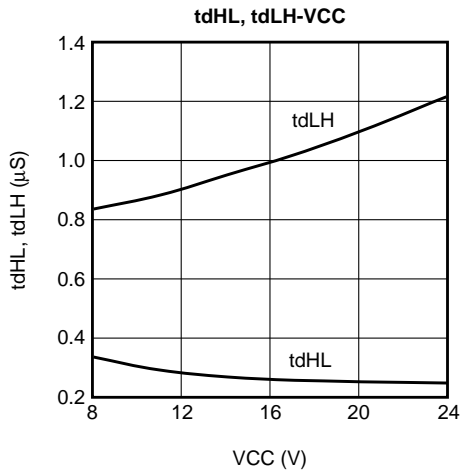
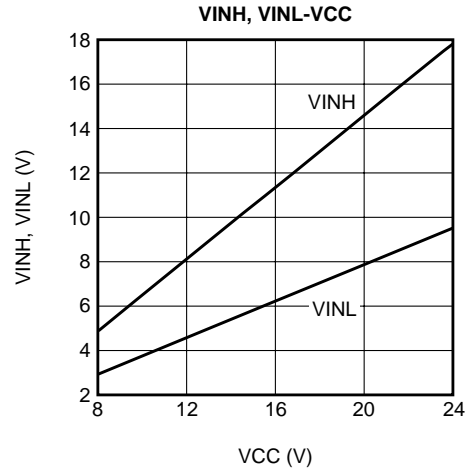
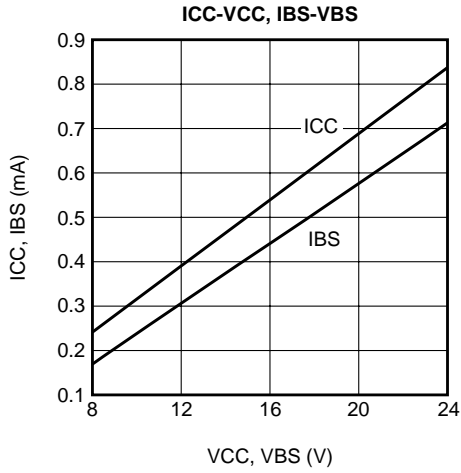

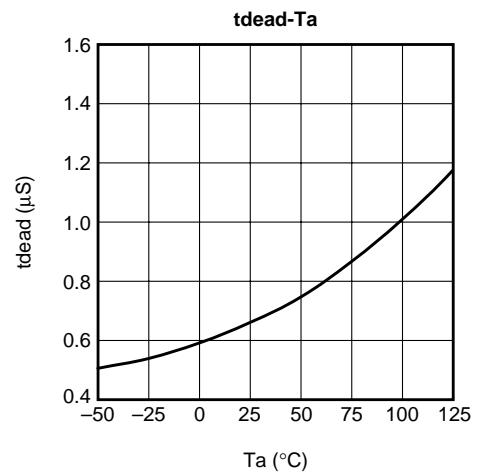
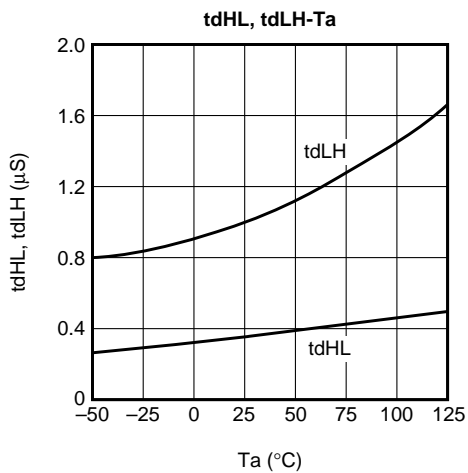
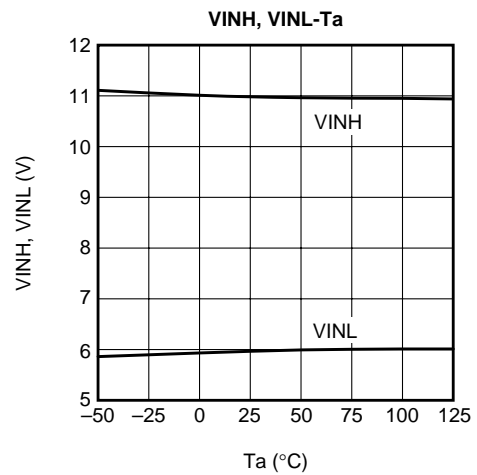
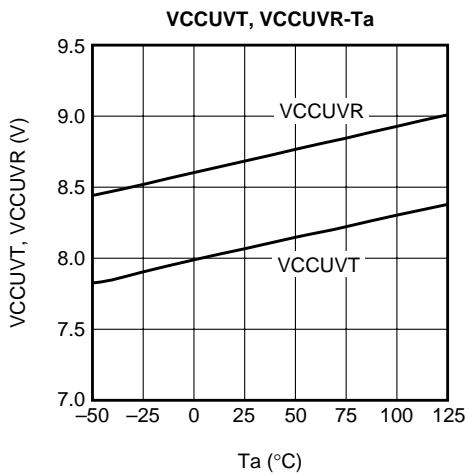
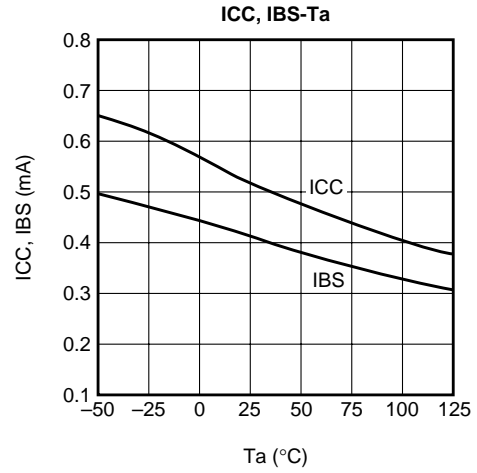
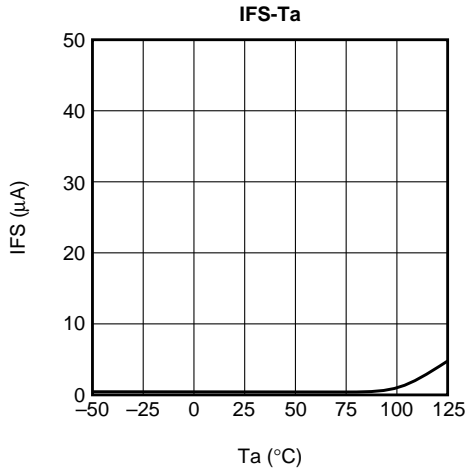

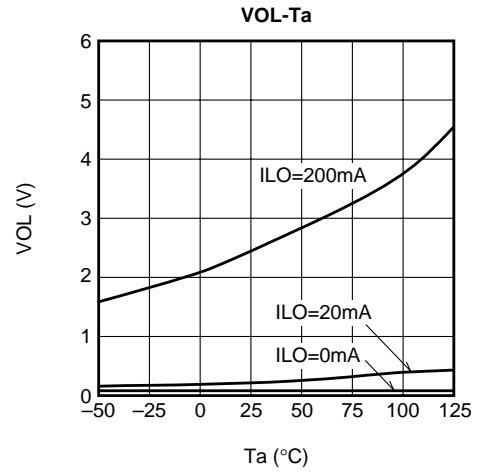
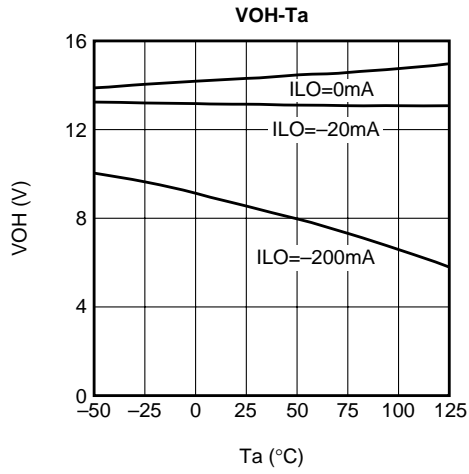

LOGIC SEQUENCE

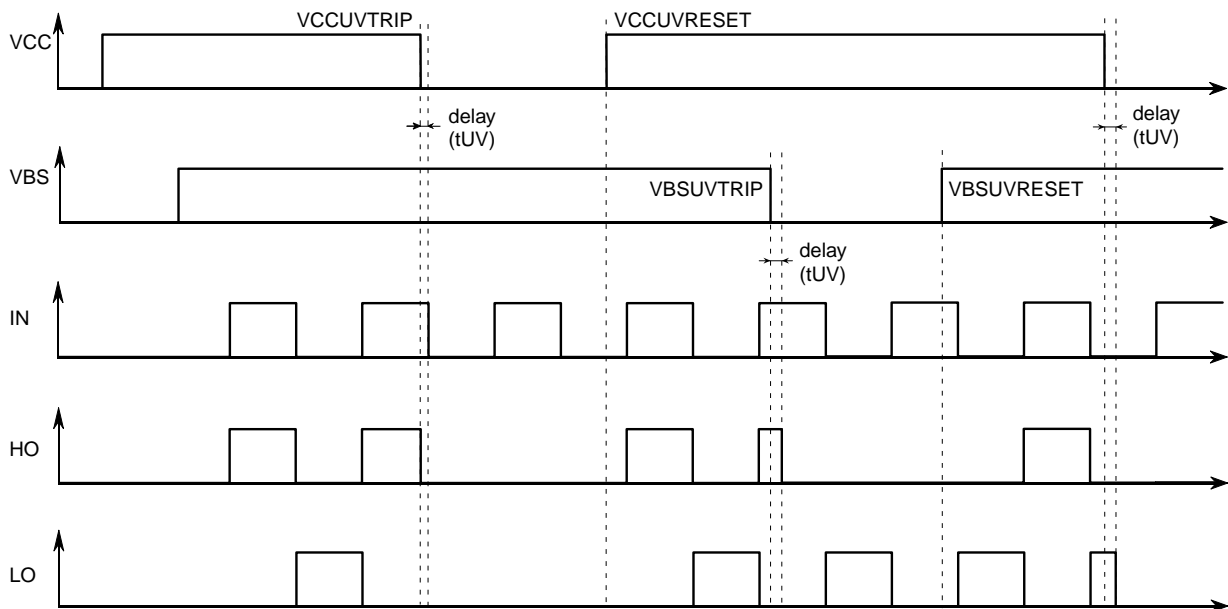

1. INPUT/OUTPUT LOGIC : HO has positive logic with reference to IN. LO has negative logic with reference to IN.
2. LOGIC DURING UV(VCC, VBS)ERROR

Error Signal	HO	LO
UV error (VCC)	HO outputs "L" level as long as UV error for VCC is detected. HO responds to IN if VCC exceeds VCCUVRESET level.	LO is locked at "L" level as long as UV error for VCC is detected. After VCC exceeds VCCUVRESET level, the lock for LO is removed following an "H" state of the IN signal, and then LO responds to the input.
UV error (VBS)	HO is locked at "L" level as long as UV error for VBS is detected. After VBS exceeds VBSUVRESET level, the lock for HO is removed following an "L" state of the IN signal, and then HO responds to the input.	LO is independent of VBS to respond to IN.

**M63994P/FP**

**HIGH VOLTAGE HALF BRIDGE DRIVER**

**PACKAGE OUTLINE**

**8P4**

Plastic 8pin 300mil DIP

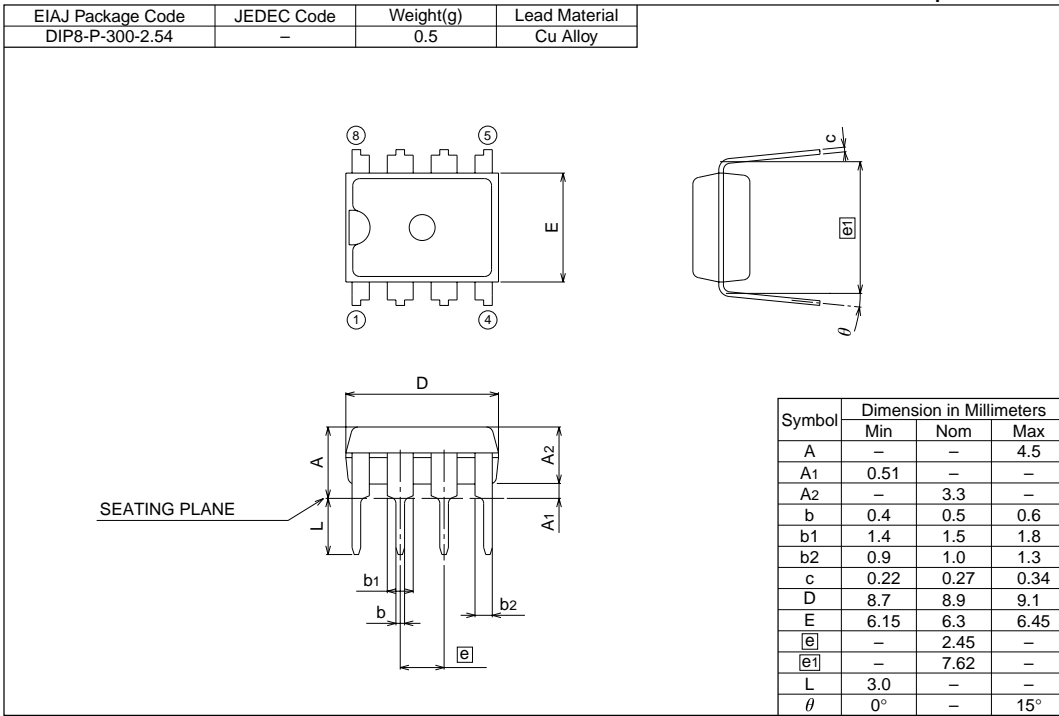

**8P2S-A**

Plastic 8pin 225mil SOP

