

M/A-COM X-Band Limiter/Low Noise Amplifier

8.5 –12.0 GHz

MA01502D

Features

- ◆ 8.5 to 12.0 GHz Operation
- ◆ 10 Watt CW On-chip Limiter
- ◆ Balanced Design –Excellent Return Loss
- ◆ Self-Aligned MSAG[®] MESFET Process

Primary Applications

- ◆ Weather Radar
- ◆ Airborne Radar

Description

The MA01502D is a balanced 2-stage low noise amplifier with on-chip, receiver protecting 10 Watt limiter. This product is fully matched to 50 ohms on both the input and output.

Each device is 100% RF tested on wafer to ensure performance compliance. The part is fabricated using M/A-COM's repeatable, high performance and highly reliable GaAs Multifunction Self-Aligned Gate (MSAG[®]) MESFET Process. This process features silicon nitride passivation and polyimide scratch protection.

8.5-12.0 GHz GaAs MMIC Amplifier

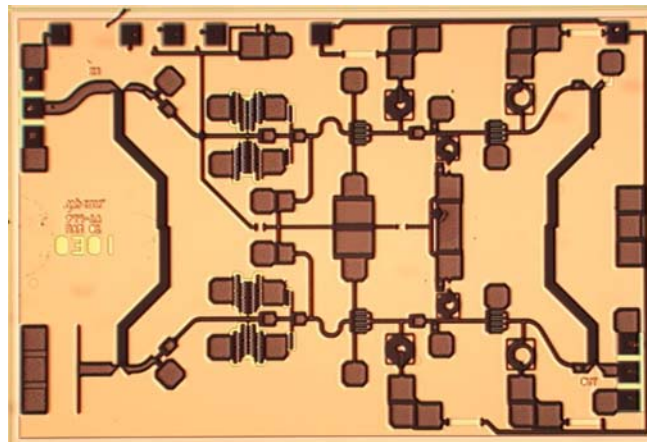

Electrical Characteristics: $T_B = 25^\circ\text{C}^1$, $Z_0 = 50\Omega$, $V_{DD} = 5\text{V}$, $V_{GG} = -5\text{V}$

Parameter	Symbol	Minimum	Typical	Maximum	Units
Bandwidth	f	8.5	-	12.0	GHz
Small Signal Gain	Gn	12	14	18	dB
1-dB Compression Point	P1dB		20		dBm
Input Return Loss	IRL	13	20		dB
Output Return Loss	ORL	13	20		dB
Noise Figure	NF		2.7	3.5	dB
Drain Current	I_{DD}		130	160	mA
Gate Current	I_{GG}		4	10	mA
Input Third Order Intercept Point	ITOI		13		dBm
Drain Current (Max at Pin= 10W)	I_{DMAX}		$40+I_{DD}$		mA
Power Handling (CW up to 30 minutes)	P_{RF}		10		W

1. T_B = MMIC Base Temperature

Maximum Operating Conditions ¹

Parameter	Symbol	Absolute Maximum	Units
Input Power	P_{IN}	15	Watts
Drain Supply Voltage	V_{DD}	8.0	V
Gate Supply Voltage	V_{GG}	-6.0	V
Quiescent Drain Current (No RF)	I_{DQ}	300	mA
Quiescent DC Power Dissipated (No RF)	P_{DISS}	2.4	W
Junction Temperature	T_J	180	°C
Storage Temperature	T_{STG}	-55 to +150	°C

1. Operation outside of these ranges may reduce product reliability. Operation at other than the typical values may result in performance outside the guaranteed limits.

Recommended Operating Conditions

Characteristic	Symbol	Min	Typ	Max	Unit
Drain Voltage	V_{DD}	4.0	5.0	6.0	V
Gate Voltage	V_{GG}	-4.5	-5.0	-5.5	V
Junction Temperature	T_J			150	°C
MMIC Base Temperature	T_B			Note 2	°C

2. Maximum MMIC Base Temperature = 150°C — 33.1 °C/W * V_{DD} * I_{DQ}

Operating Instructions

This device is static sensitive. Please handle with care. To operate the device, follow these steps.

1. Apply $V_{GG} = -5$ V, $V_{DD} = 0$ V.
2. Ramp V_{DD} to desired voltage, typically 5 V.
3. Adjust V_{GG} to set I_{DQ} , (approximately @ -5 V).
4. Set RF input.
5. Power down sequence in reverse. Turn gate voltage off last.

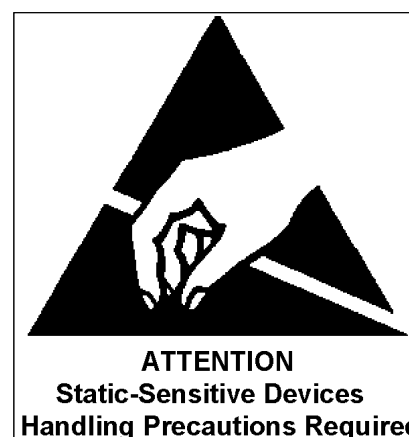

Specifications subject to change without notice.

Customer Service: Tel. (888)563-3949

Email: macom_adbu_ics@tycoelectronics.com

■ **North America:** Tel. (800) 366-2266

■ **Asia/Pacific:** Tel.+81-44-844-8296, Fax +81-44-844-8298

■ **Europe:** Tel. +44 (1344) 869 595, Fax+44 (1344) 300 020

tyco / Electronics

MACOM

Visit www.macom.com for additional data sheets and product information.

Typical Small Signal Characteristics ($V_{DD}=5V$, $V_{GG}=-5V$)

Typical Measured Gain and Noise Figure of the Two-stage Limiter/LNA

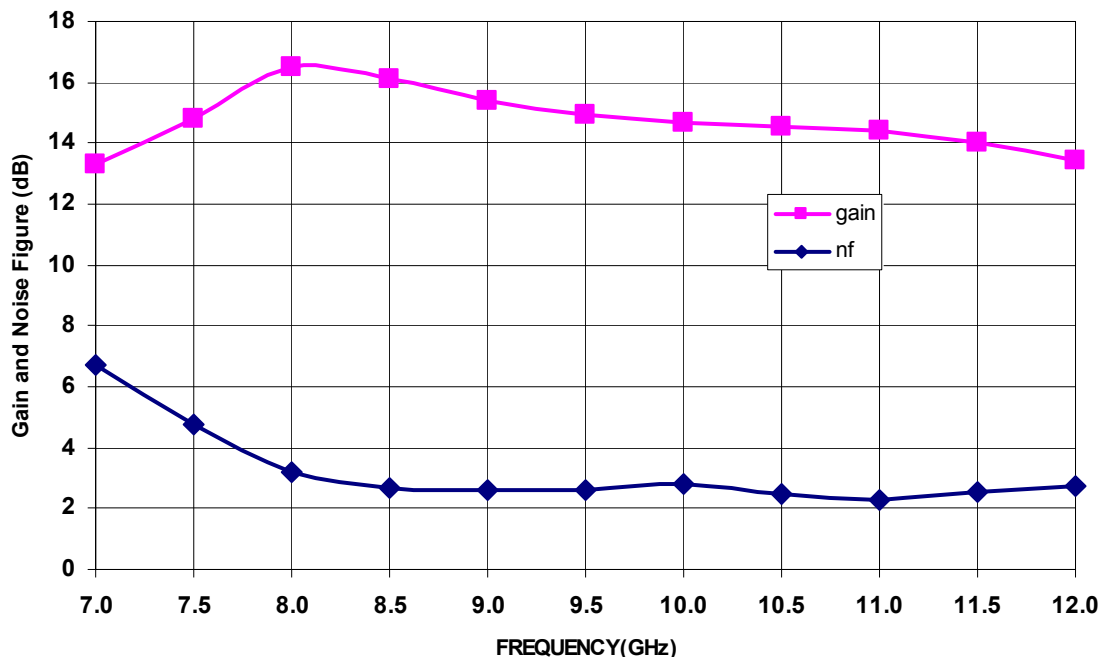

Typical Measured S_{11} and S_{22} of the Two-stage Limiter/LNA

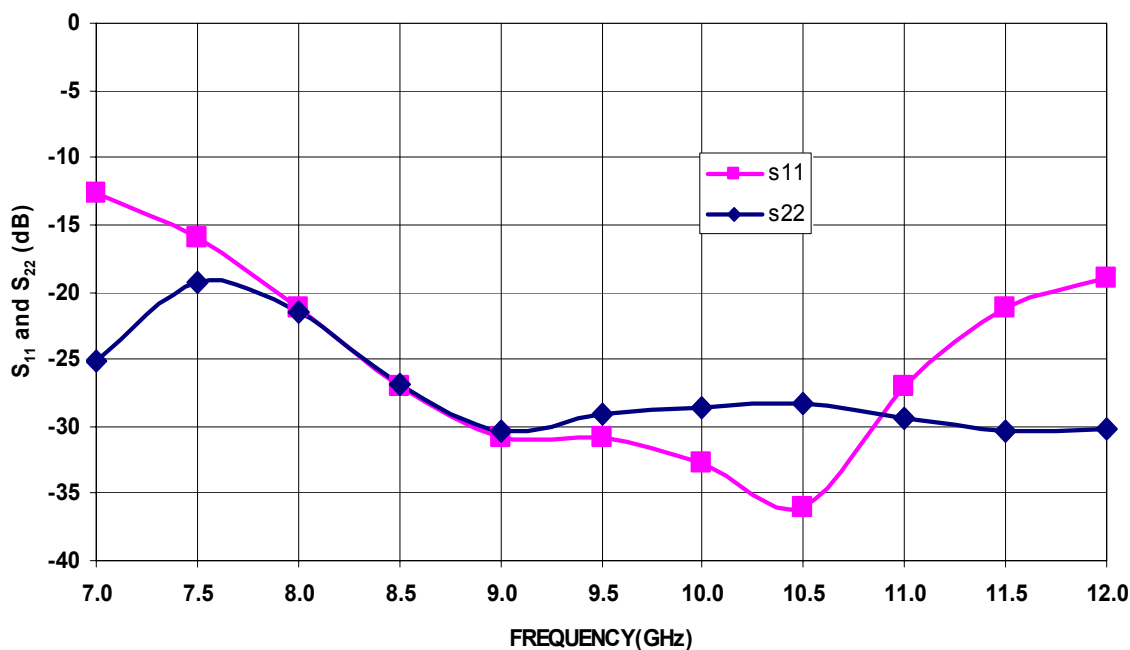

Specifications subject to change without notice.

Customer Service: Tel. (888)563-3949

Email: macom_adbu_ics@tycoelectronics.com

■ North America: Tel. (800) 366-2266

■ Asia/Pacific: Tel. +81-44-844-8296, Fax +81-44-844-8298

■ Europe: Tel. +44 (1344) 869 595, Fax+44 (1344) 300 020

tyco / Electronics

MACOM

Visit www.macom.com for additional data sheets and product information.

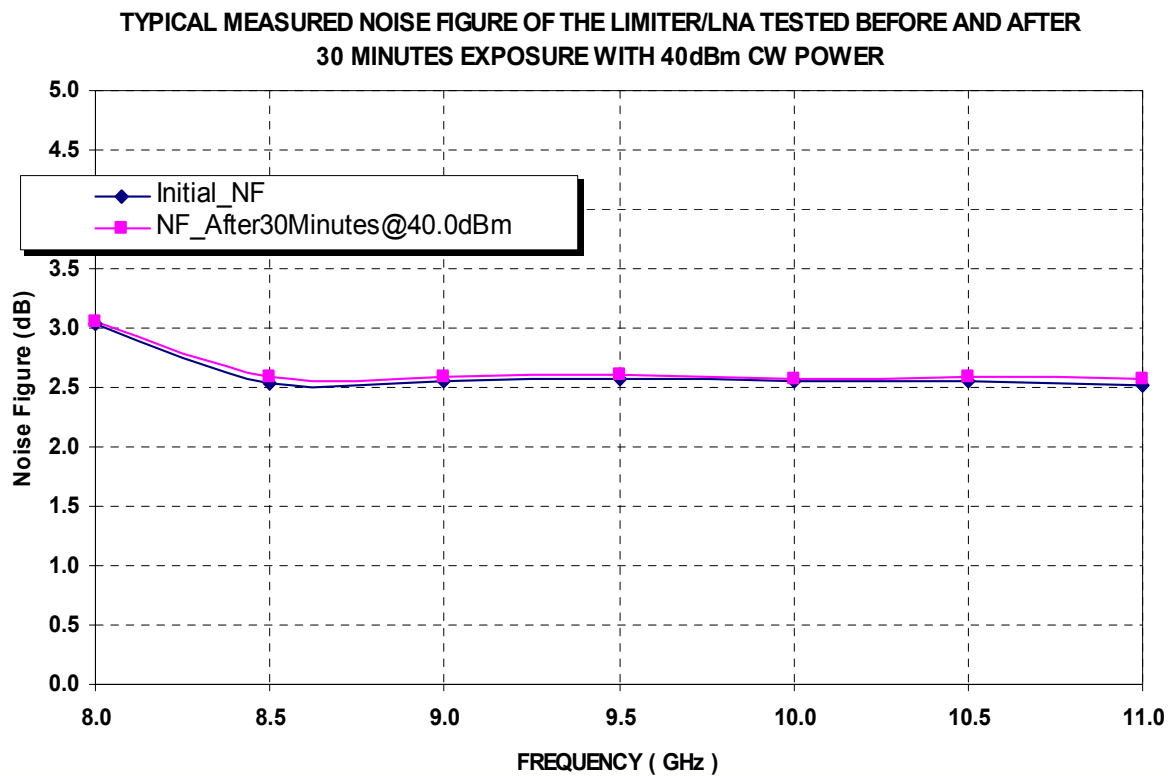
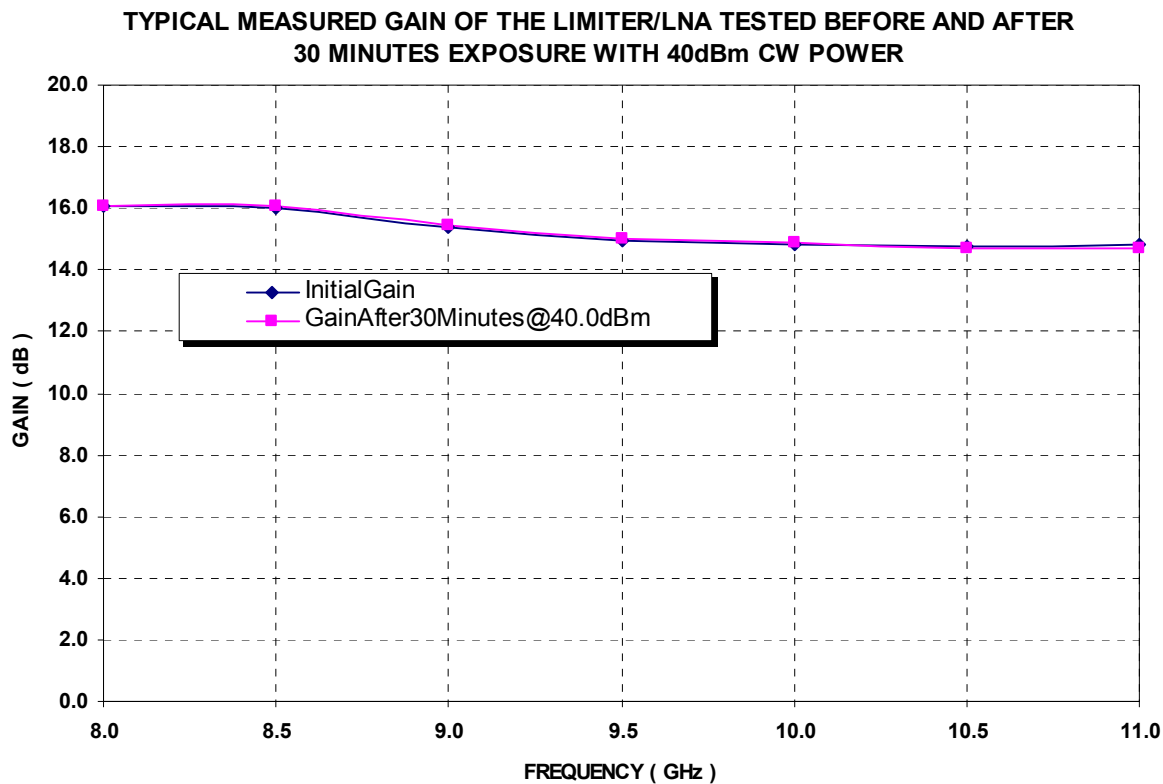

Specifications subject to change without notice.

Customer Service: Tel. (888)563-3949

Email: macom_adbu_ics@tycoelectronics.com

■ North America: Tel. (800) 366-2266

■ Asia/Pacific: Tel. +81-44-844-8296, Fax +81-44-844-8298

■ Europe: Tel. +44 (1344) 869 595, Fax+44 (1344) 300 020

tyco / Electronics

MACOM

Visit www.macom.com for additional data sheets and product information.

Mechanical Information

Chip Size: 4.580 x 3.080 x 0.125 mm (181 x 122 x 5 mils)

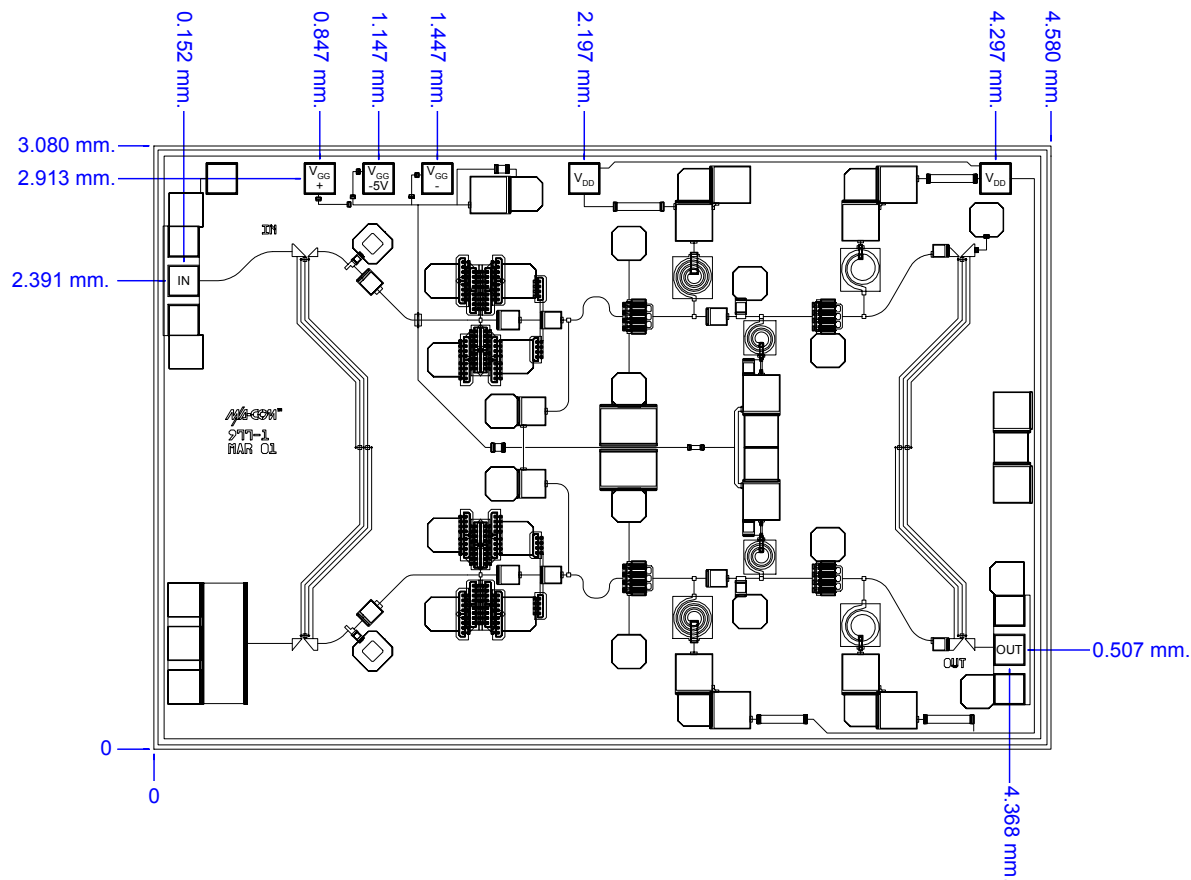

Bond Pad Dimensions

Pad	Size (μm)	Size (mils)
RF In and Out	150 x 150	6 x 6
DC Drain Supply Voltage VDD	150 x 150	6 x 6
DC Gate Supply Voltage VGG	150 x 150	6 x 6

Specifications subject to change without notice.

Customer Service: Tel. (888)563-3949

Email: macom_adbu_ics@tycoelectronics.com

- North America: Tel. (800) 366-2266
- Asia/Pacific: Tel. +81-44-844-8296, Fax +81-44-844-8298
- Europe: Tel. +44 (1344) 869 595, Fax+44 (1344) 300 020

tyco / Electronics

MACOM

Visit www.macom.com for additional data sheets and product information.

Assembly and Bonding Diagram

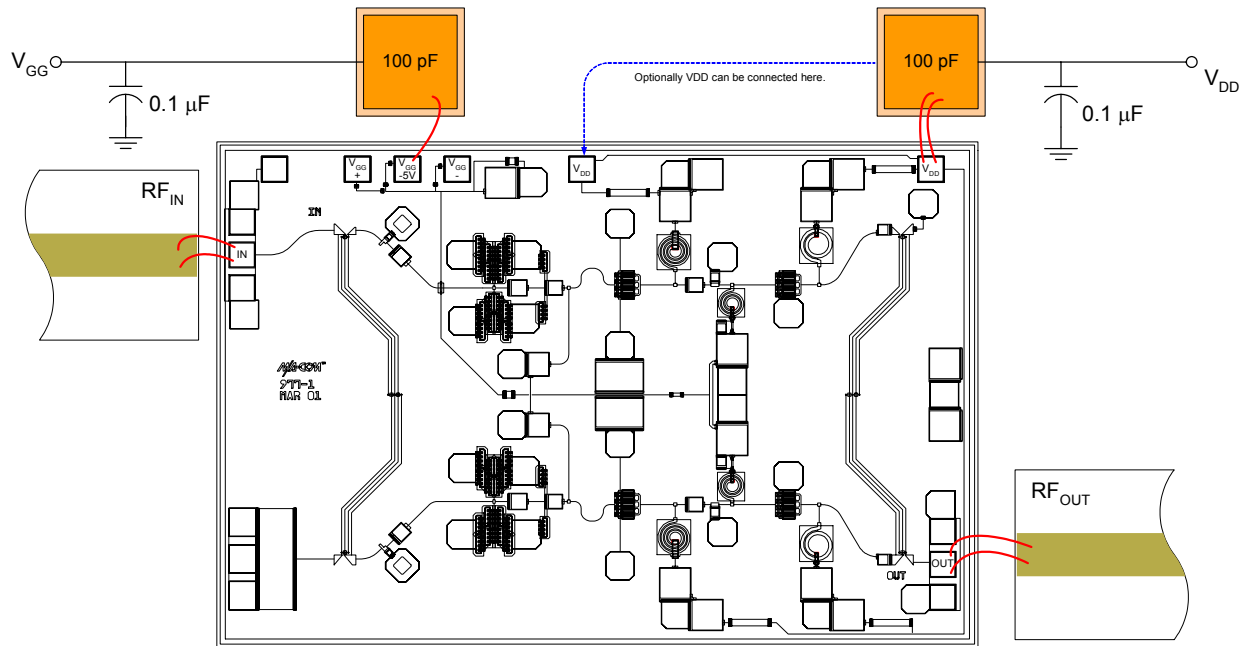

Recommended bonding diagram.

Support circuitry typical of MMIC characterization fixture for CW testing.



Assembly Instructions:

Die attach: Use AuSn (80/20) 1-2 mil. preform solder. Limit time @ 300 °C to less than 5 minutes.

Wirebonding: Bond @ 160 °C using standard ball or thermal compression wedge bond techniques. For DC pad connections, use either ball or wedge bonds. For best RF performance, use wedge bonds of shortest length, although ball bonds are also acceptable.

Biasing Note: Must apply negative bias to V_{GG} before applying positive bias to V_{DD} to prevent damage to amplifier.

Specifications subject to change without notice.

Customer Service: Tel. (888)563-3949

Email: macom_adbu_ics@tycoelectronics.com

- North America: Tel. (800) 366-2266
- Asia/Pacific: Tel. +81-44-844-8296, Fax +81-44-844-8298
- Europe: Tel. +44 (1344) 869 595, Fax+44 (1344) 300 020

tyco / Electronics

MACOM

Visit www.macom.com for additional data sheets and product information.