

MAC12D, MAC12M, MAC12N

Triacs

Silicon Bidirectional Thyristors

Designed for high performance full-wave ac control applications where high noise immunity and commutating di/dt are required.

- Blocking Voltage to 800 Volts
- On-State Current Rating of 12 Amperes RMS at 70°C
- Uniform Gate Trigger Currents in Three Quadrants, Q1, Q2, and Q3
- High Immunity to dv/dt — 250 V/μs Minimum at 125°C
- High Commutating di/dt — 6.5 A/ms Minimum at 125°C
- Industry Standard TO-220 AB Package
- High Surge Current Capability — 100 Amperes
- Device Marking: Logo, Device Type, e.g., MAC12D, Date Code

MAXIMUM RATINGS (T_J = 25°C unless otherwise noted)

Rating	Symbol	Value	Unit
Peak Repetitive Off-State Voltage ⁽¹⁾ (T _J = -40 to 125°C, Sine Wave, 50 to 60 Hz, Gate Open)	V _{DRM} , V _{RRM}		Volts
MAC12D		400	
MAC12M		600	
MAC12N		800	
On-State RMS Current (All Conduction Angles; T _C = 70°C)	I _{T(RMS)}	12	A
Peak Non-Repetitive Surge Current (One Full Cycle, 60 Hz, T _J = 125°C)	I _{TSM}	100	A
Circuit Fusing Consideration (t = 8.33 ms)	I ² t	41	A ² sec
Peak Gate Power (Pulse Width ≤ 1.0 μs, T _C = 80°C)	P _{GM}	16	Watts
Average Gate Power (t = 8.3 ms, T _C = 80°C)	P _{G(AV)}	0.35	Watts
Operating Junction Temperature Range	T _J	-40 to +125	°C
Storage Temperature Range	T _{stg}	-40 to +150	°C



KERSEMI

www.kersemi.com

TRIACS
12 AMPERES RMS
400 thru 800 VOLTS

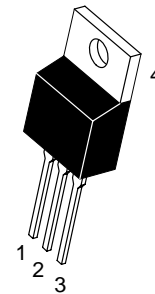
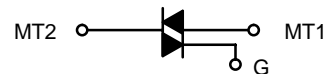

TO-220AB
CASE 221A
STYLE 4

PIN ASSIGNMENT

1	Main Terminal 1
2	Main Terminal 2
3	Gate
4	Main Terminal 2

ORDERING INFORMATION

Device	Package	Shipping
MAC12D	TO220AB	50 Units/Rail
MAC12M	TO220AB	50 Units/Rail
MAC12N	TO220AB	50 Units/Rail

MAC12D, MAC12M, MAC12N

THERMAL CHARACTERISTICS

Characteristic	Symbol	Value	Unit
Thermal Resistance — Junction to Case — Junction to Ambient	$R_{\theta JC}$ $R_{\theta JA}$	2.2 62.5	$^{\circ}C/W$
Maximum Lead Temperature for Soldering Purposes 1/8" from Case for 10 Seconds	T_L	260	$^{\circ}C$

ELECTRICAL CHARACTERISTICS ($T_J = 25^{\circ}C$ unless otherwise noted; Electricals apply in both directions)

Characteristic	Symbol	Min	Typ	Max	Unit
----------------	--------	-----	-----	-----	------

OFF CHARACTERISTICS

Peak Repetitive Blocking Current ($V_D = \text{Rated } V_{DRM}, V_{RRM}, \text{ Gate Open}$)	$T_J = 25^{\circ}C$ $T_J = 125^{\circ}C$	I_{DRM} I_{RRM}	— —	— —	0.01 2.0	mA
---	---	------------------------	--------	--------	-------------	----

ON CHARACTERISTICS

Peak On-State Voltage ⁽¹⁾ ($I_{TM} = \pm 17 \text{ A}$)	V_{TM}	—	—	1.85	Volts
Gate Trigger Current (Continuous dc) ($V_D = 12 \text{ V}, R_L = 100 \Omega$) MT2(+), G(+) MT2(+), G(-) MT2(-), G(-)	I_{GT}	5.0 5.0 5.0	13 13 13	35 35 35	mA
Hold Current ($V_D = 12 \text{ V}, \text{ Gate Open}, \text{ Initiating Current} = \pm 150 \text{ mA}$)	I_H	—	20	40	mA
Latch Current ($V_D = 24 \text{ V}, I_G = 35 \text{ mA}$) MT2(+), G(+) MT2(+), G(-) MT2(-), G(-)	I_L	— — —	20 30 20	50 80 50	mA
Gate Trigger Voltage (Continuous dc) ($V_D = 12 \text{ V}, R_L = 100 \Omega$) MT2(+), G(+) MT2(+), G(-) MT2(-), G(-)	V_{GT}	0.5 0.5 0.5	0.78 0.70 0.71	1.5 1.5 1.5	Volts

DYNAMIC CHARACTERISTICS

Rate of Change of Commutating Current ($V_D = 400 \text{ V}, I_{TM} = 4.4 \text{ A}, \text{ Commutating } dv/dt = 18 \text{ V}/\mu\text{s}, \text{ Gate Open}, T_J = 125^{\circ}C, f = 250 \text{ Hz}, \text{ No Snubber}$)	$(di/dt)_c$	6.5	—	—	A/ms
Critical Rate of Rise of Off-State Voltage ($V_D = \text{Rated } V_{DRM}, \text{ Exponential Waveform}, \text{ Gate Open}, T_J = 125^{\circ}C$)	dv/dt	250	500	—	V/ μs
Repetitive Critical Rate of Rise of On-State Current IPK = 50 A; PW = 40 μsec ; $di_G/dt = 200 \text{ mA}/\mu\text{sec}$; $f = 60 \text{ Hz}$	di/dt	—	—	10	A/ μs

(1) Pulse Test: Pulse Width $\leq 2.0 \text{ ms}$, Duty Cycle $\leq 2\%$.

MAC12D, MAC12M, MAC12N

Voltage Current Characteristic of Triacs (Bidirectional Device)

Symbol	Parameter
V_{DRM}	Peak Repetitive Forward Off State Voltage
I_{DRM}	Peak Forward Blocking Current
V_{RRM}	Peak Repetitive Reverse Off State Voltage
I_{RRM}	Peak Reverse Blocking Current
V_{TM}	Maximum On State Voltage
I_H	Holding Current

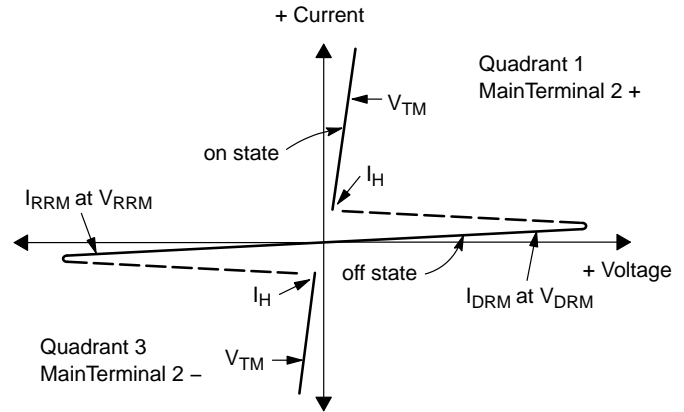

Quadrant Definitions for a Triac

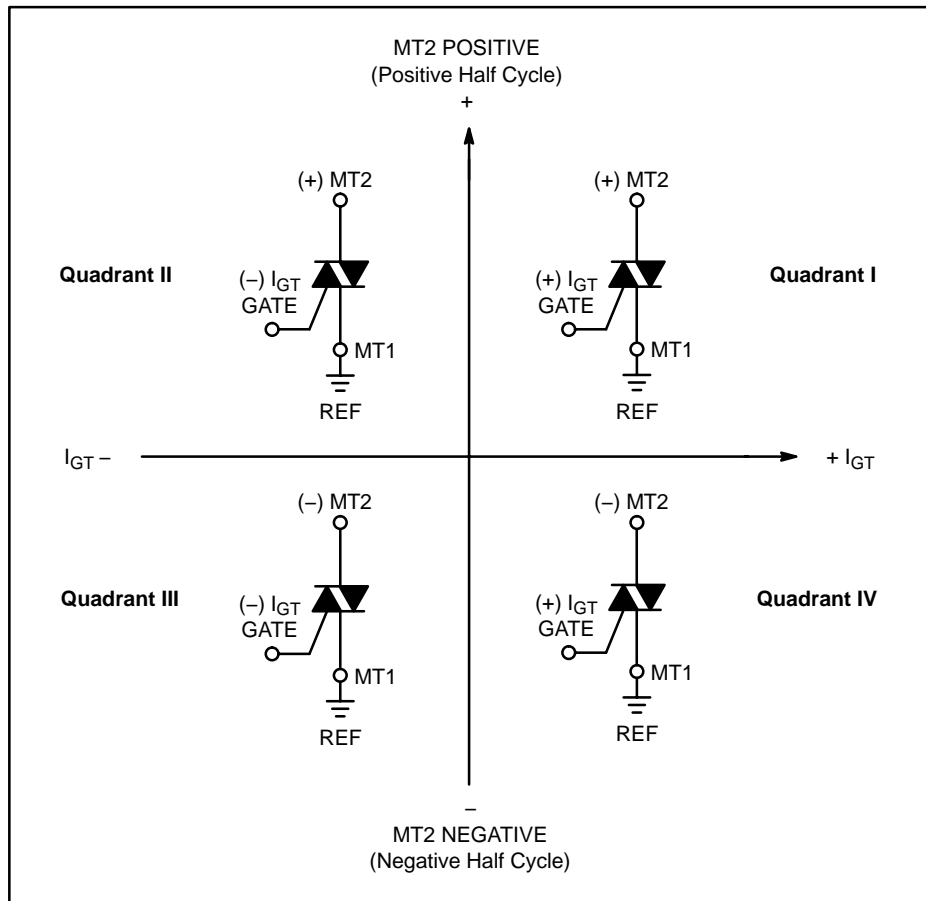

All polarities are referenced to MT1.
 With in-phase signals (using standard AC lines) quadrants I and III are used.

MAC12D, MAC12M, MAC12N

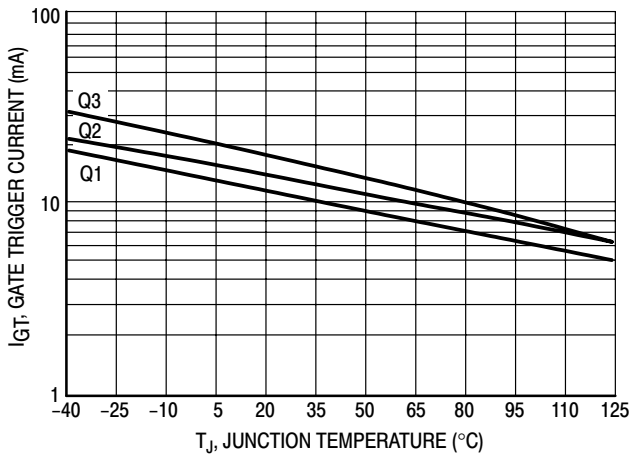

Figure 1. Typical Gate Trigger Current versus Junction Temperature

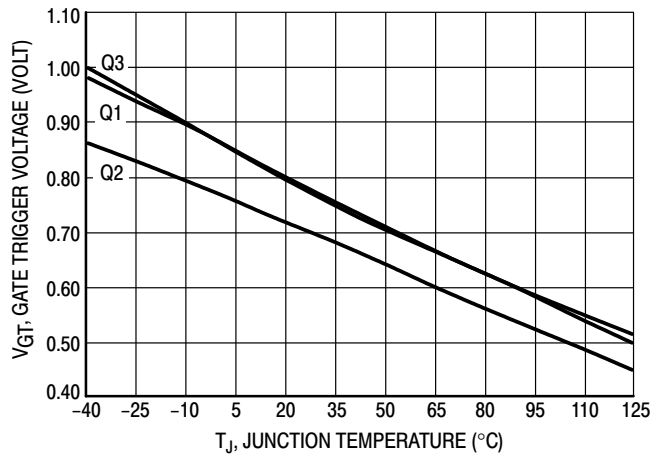

Figure 2. Typical Gate Trigger Voltage versus Junction Temperature

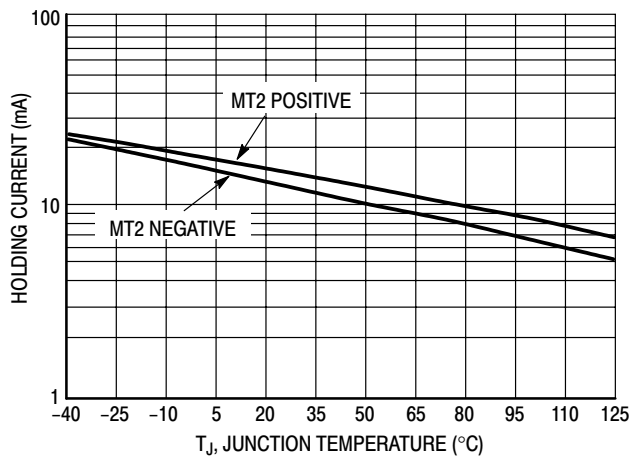

Figure 3. Typical Holding Current versus Junction Temperature

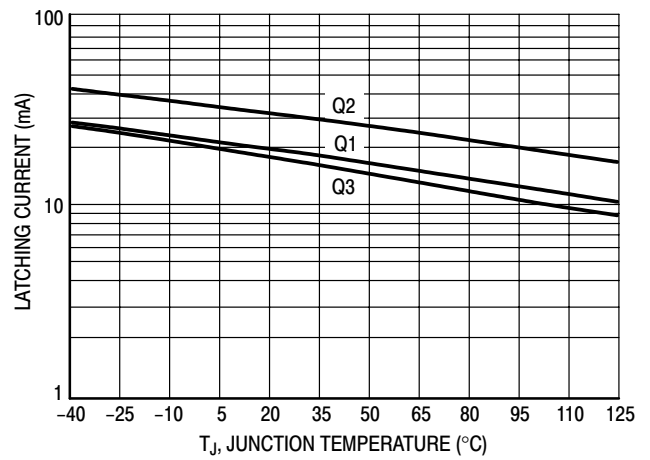

Figure 4. Typical Latching Current versus Junction Temperature

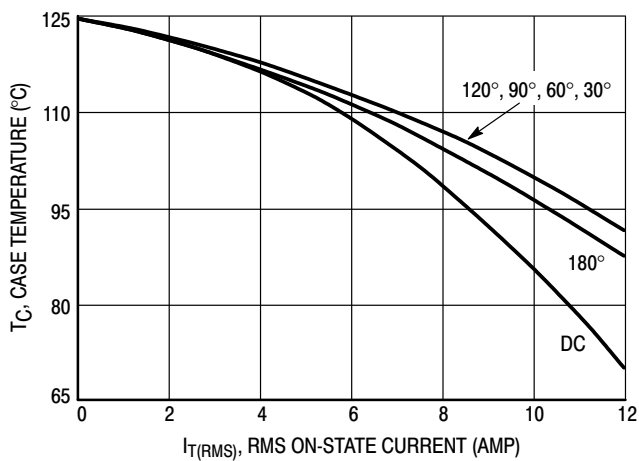

Figure 5. Typical RMS Current Derating

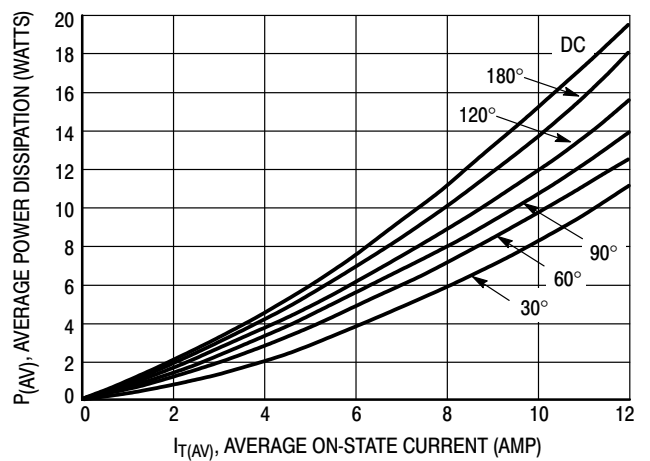

Figure 6. On-State Power Dissipation

MAC12D, MAC12M, MAC12N

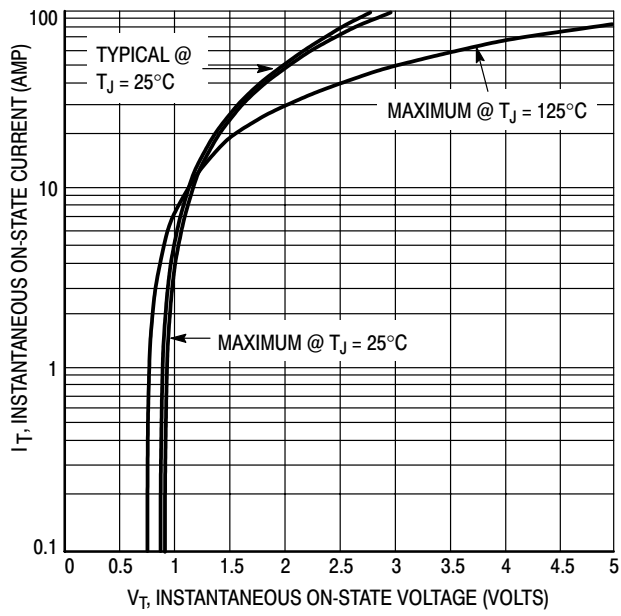

Figure 7. Typical On-State Characteristics

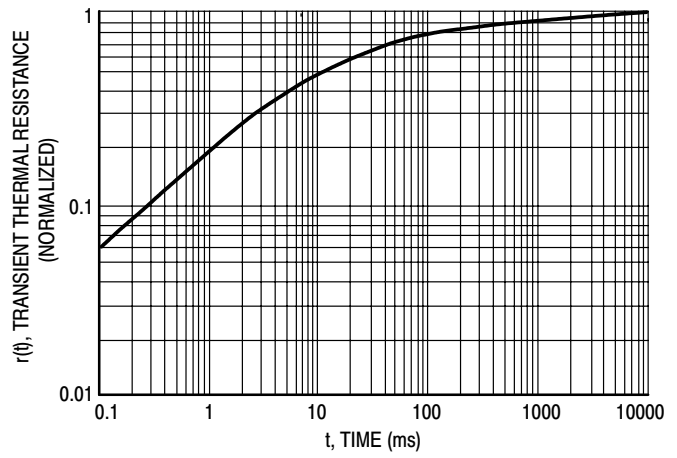
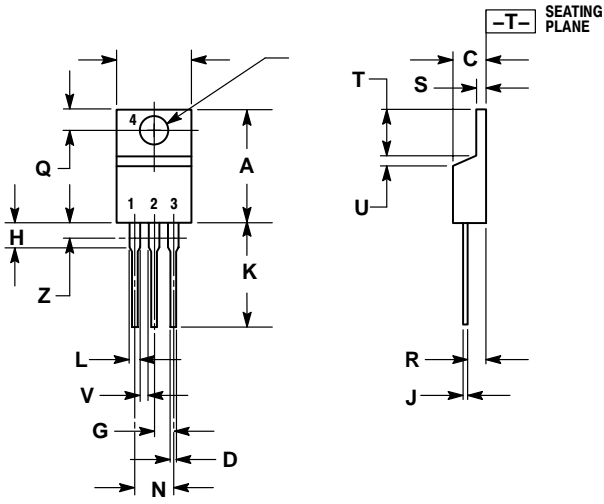

Figure 8. Typical Thermal Response

MAC12D, MAC12M, MAC12N

PACKAGE DIMENSIONS

TO-220AB
CASE 221A-09
ISSUE Z



- NOTES:
1. DIMENSIONING AND TOLERANCING PER ANSI Y14.5M, 1982.
 2. CONTROLLING DIMENSION: INCH.
 3. DIMENSION Z DEFINES A ZONE WHERE ALL BODY AND LEAD IRREGULARITIES ARE ALLOWED.

DIM	INCHES		MILLIMETERS	
	MIN	MAX	MIN	MAX
A	0.570	0.620	14.48	15.75
B	0.380	0.405	9.66	10.28
C	0.160	0.190	4.07	4.82
D	0.025	0.035	0.64	0.88
F	0.142	0.147	3.61	3.73
G	0.095	0.105	2.42	2.66
H	0.110	0.155	2.80	3.93
J	0.018	0.025	0.46	0.64
K	0.500	0.562	12.70	14.27
L	0.045	0.060	1.15	1.52
N	0.190	0.210	4.83	5.33
Q	0.100	0.120	2.54	3.04
R	0.080	0.110	2.04	2.79
S	0.045	0.055	1.15	1.39
T	0.235	0.255	5.97	6.47
U	0.000	0.050	0.00	1.27
V	0.045	---	1.15	---
Z	---	0.080	---	2.04

- STYLE 4:
PIN 1. MAIN TERMINAL 1
2. MAIN TERMINAL 2
3. GATE
4. MAIN TERMINAL 2