



LED Light Management IC in 2.5mm x 2.5mm UCSP

MAX8830

General Description

The MAX8830 light management IC integrates a 400mA (guaranteed) PWM DC-DC step-up converter, a 320mA white LED camera flash current sink, and four programmable LED current sinks. The internal 1MHz step-up converter features an internal switching MOSFET and synchronous rectifier to improve efficiency and minimize external component count. The camera flash output current and maximum timer is programmable through I²C. Each LED current is individually regulated to a programmable level (from off to 10mA in 32 steps) and is completely independent of each other.

An I²C interface controls individual on/off of all outputs, step-up output voltage setting, movie/flash current, flash timer duration settings, and individual LED current sink settings.

The MAX8830 is available in a 16-bump UCSP™ package (2.5mm x 2.5mm).

Applications

Cell Phones and Smartphones
PDAs and MP3 Players

Typical Operating Circuit

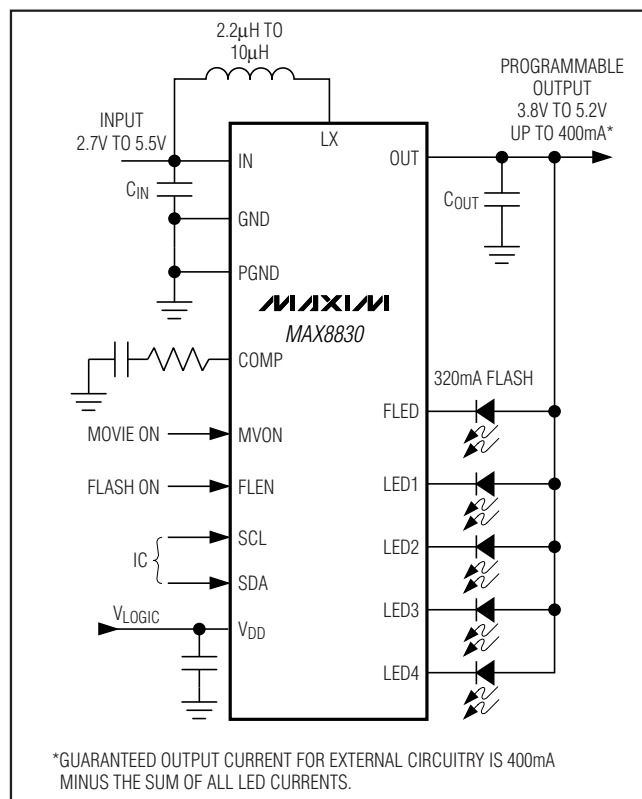

Features

- ◆ **Step-Up DC-DC Converter**
 - 400mA Guaranteed Output Current
 - Over 90% Efficiency
 - On-Chip FET and Synchronous Rectifier
 - Fixed 1MHz PWM Switching
 - Small 2.2µH to 10µH Inductor
 - I²C-Programmable V_{OUT} (3.8V to 5.2V and Off in 16 Steps)
- ◆ **Flash LED Current Sink**
 - I²C-Programmable Flash Output Current (Off to 320mA in 32 Steps)
 - I²C-Programmable Flash Maximum Timer (0.5s, 1.0s, 1.5s, or 2.0s)
 - I²C-Programmable Movie Output Current (Off to 160mA in 16 Steps)
 - Movie Enabled by I²C or Logic Input
 - Flash Enabled by Logic Input
 - Low Dropout (75mV typ)
- ◆ **Four LED Current Sinks**
 - Individually I²C-Programmable Output Current
 - Off to 10mA in 32 Steps
 - Low LED Sink Current Dropout Voltage (30mV typ)
- ◆ **I²C Interface**
 - Write Address (0x94), Read Address (0x95)
 - Individual On/Off and LED Current Settings
 - Simple Register Mapping
- ◆ < 1µA Shutdown Current
- ◆ Open/Short LED Detection
- ◆ Thermal-Shutdown Protection
- ◆ 16-Bump, 2.5mm x 2.5mm UCSP Package

Ordering Information

PART	TEMP RANGE	PIN-PACKAGE
MAX8830EWE+T	-40°C to +85°C	16 UCSP (2.5mm x 2.5mm)

+Denotes a lead-free package.

Pin Configuration appears at the end of data sheet.

UCSP is a trademark of Maxim Integrated Products, Inc.



Maxim Integrated Products 1

For pricing, delivery, and ordering information, please contact Maxim Direct at 1-888-629-4642, or visit Maxim's website at www.maxim-ic.com.

LED Light Management IC in 2.5mm x 2.5mm UCSP

ABSOLUTE MAXIMUM RATINGS

IN, OUT to GND	-0.3V to +6.0V
IN, OUT to GND (maximum of 1µs)	+7.0V
V _{DD} to GND	-0.3V to +4.0V
SCL, SDA, MVON, FLEN to GND	-0.3V to V _{DD} + 0.3V
COMP, FLED, LED_ to GND	-0.3V to V _{OUT} + 0.3V
PGND to GND	-0.3V to +0.3V
Continuous I _{LX} Current	1A _{RMS}

Continuous Power Dissipation (T _A = +70°C)	
16-Bump 2.5mm x 2.5mm UCSP	
(derate 105.7mW/°C above +70°C)	750mW
Operating Temperature Range	-40°C to +85°C
Junction Temperature	+150°C
Storage Temperature Range	-65°C to +150°C
Bump Temperature* (soldering)	+235°C

*This device is constructed using a unique set of packaging techniques that impose a limit on the thermal profile the device can be exposed to during board level solder attach and rework. This limit permits only the use of the solder profiles recommended in the industry-standard specification, JEDEC 020A, paragraph 7.6, Table 3 for IR/VPR and Convection reflow. Preheating is required. Hand or wave soldering is not allowed.

Stresses beyond those listed under "Absolute Maximum Ratings" may cause permanent damage to the device. These are stress ratings only, and functional operation of the device at these or any other conditions beyond those indicated in the operational sections of the specifications is not implied. Exposure to absolute maximum rating conditions for extended periods may affect device reliability.

ELECTRICAL CHARACTERISTICS

(V_{IN} = 3.6V, V_{GND} = V_{PGND} = 0V, V_{DD} = 3.0V, T_A = -40°C to +85°C, unless otherwise noted. Typical values are at T_A = +25°C.) (Note 1)

PARAMETER	DESCRIPTION	MIN	TYP	MAX	UNITS
IN Operating Voltage		2.7		5.5	V
V _{DD} Operating Range		1.7		3.6	V
V _{DD} Undervoltage Lockout (UVLO) Threshold	V _{DD} falling	1.35	1.5	1.65	V
V _{DD} UVLO Hysteresis			50		mV
IN UVLO Threshold	V _{IN} rising	2.25	2.45	2.65	V
IN UVLO Hysteresis			50		mV
V _{DD} Standby Supply Current	SCL = SDA = V _{DD} , I ² C ready	T _A = +25°C	3	10	µA
		T _A = +85°C	4		
IN Standby Supply Current	SCL = SDA = V _{DD} , I ² C ready	T _A = +25°C	5	15	µA
		T _A = +85°C	5		
IN Shutdown Supply Current	All outputs off, V _{DD} = 0	T _A = +25°C	0.1	5	µA
		T _A = +85°C	1		
Thermal-Shutdown Hysteresis			20		°C
Thermal-Shutdown			+160		°C
LOGIC AND I²C INTERFACE					
Logic Input-High Voltage	V _{DD} = 1.7V to 3.6V	MVON, FLEN	1.6		V
		SCL, SDA	0.7 x V _{DD}		
Logic Input-Low Voltage	V _{DD} = 1.7V to 3.6V	MVON, FLEN		0.4	V
		SCL, SDA		0.3 x V _{DD}	
Logic Input Current	V _{IL} = 0V or V _{IH} = 3.6V	T _A = +25°C	-1	0.01	µA
		T _A = +85°C		0.1	
SDA Output Low Voltage	I _{SDA} = 3mA		0.03	0.4	V
I ² C Clock Frequency				400	kHz
Bus-Free Time Between START and STOP	t _{BUF}	1.3			µs
Hold Time Repeated START Condition	t _{HD_STA}	0.6	0.1		µs
SCL Low Period	t _{LOW}	1.3	0.2		µs

LED Light Management IC in 2.5mm x 2.5mm UCSP

MAX8830

ELECTRICAL CHARACTERISTICS (continued)

($V_{IN} = 3.6V$, $V_{GND} = V_{PGND} = 0V$, $V_{DD} = 3.0V$, $T_A = -40^{\circ}C$ to $+85^{\circ}C$, unless otherwise noted. Typical values are at $T_A = +25^{\circ}C$.) (Note 1)

PARAMETER	DESCRIPTION	MIN	TYP	MAX	UNITS	
SCL High Period	t_{HIGH}	0.6	0.2		μs	
Setup Time Repeated START Condition	t_{SU_STA}	0.6	0.1		μs	
SDA Hold Time	t_{HD_DAT}	0	-0.01		μs	
SDA Setup Time	t_{SU_DAT}	100	50		ns	
Setup Time for STOP Condition	t_{SU_STO}	0.6	0.1		μs	
STEP-UP DC-DC CONVERTER						
IN Supply Current	1MHz switching, $V_{OUT} = 5V$ (see Note 4)		5.5	10.0	mA	
OUT Voltage Range	100mV steps	3.8		5.2	V	
OUT Voltage Accuracy	$I_{OUT} = 100mA$	$T_A = +25^{\circ}C$	-1.5	± 0.3	+1.5	%
		$T_A = +85^{\circ}C$	-3		+3	
Line Regulation	$V_{IN} = 2.7V$ to $4.2V$		0.1		%/V	
Load Regulation	$I_{OUT} = 0$ to $400mA$		0.5		%/A	
Maximum OUT Current	$V_{IN} \geq 3.2V$, $V_{OUT} = 5.0V$	400	700		mA	
nFET Current Limit			2.2		A	
LX nFET On-Resistance	LX to PGND, $I_{LX} = 100mA$		0.1		Ω	
LX pFET On-Resistance	LX to OUT, $I_{LX} = 100mA$		0.15		Ω	
LX Leakage	$V_{LX} = 5.5V$	$T_A = +25^{\circ}C$	0.1	5	μA	
		$T_A = +85^{\circ}C$	1			
Operating Frequency	$T_A = -40^{\circ}C$ to $+85^{\circ}C$	0.75	1.00	1.25	MHz	
Maximum Duty Cycle		65	75		%	
Minimum Duty Cycle			4	8	%	
COMP Transconductance	$V_{COMP} = 1.5V$		60		μS	
COMP Discharge Resistance	During shutdown or UVLO, from COMP to GND		180		Ω	
OUT Discharge Resistance	During shutdown or UVLO, from OUT to IN		10		k Ω	
FLED CURRENT SINK DRIVER						
IN Supply Current	Step-up off, FLED on		0.35	0.6	mA	
Maximum Current Setting	Flash (enabled by FLEN)		320		mA	
	Movie (enabled by MVON or I ² C)		160			
Current Accuracy	50mA setting, Movie	$T_A = +25^{\circ}C$	-3.0	± 0.5	+3.0	%
		$T_A = -40^{\circ}C$ to $+85^{\circ}C$	-5		+5	
Current-Regulator Dropout	50mA setting (Note 2)		75		mV	
FLED Leakage in Shutdown	$T_A = +25^{\circ}C$		0.01	5	μA	
	$T_A = +85^{\circ}C$		0.1			
Flash Duration Timer Range	In 500ms steps (Note 3)	0.5		2.0	s	
Open-LED Detection Threshold	FLED enabled		100		mV	
Shorted-LED Detection Threshold	FLED enabled		$V_{OUT} - 1V$		V	

LED Light Management IC in 2.5mm x 2.5mm UCSP

ELECTRICAL CHARACTERISTICS (continued)

($V_{IN} = 3.6V$, $V_{GND} = V_{PGND} = 0V$, $V_{DD} = 3.0V$, $T_A = -40^{\circ}C$ to $+85^{\circ}C$, unless otherwise noted. Typical values are at $T_A = +25^{\circ}C$.) (Note 1)

PARAMETER	DESCRIPTION	MIN	TYP	MAX	UNITS	
LED1–LED4 CURRENT SINK DRIVER						
IN Supply Current	Step-up off, all current sinks on		0.2	0.5	mA	
Maximum Current Setting			10		mA	
Current Accuracy	LED1–LED4 = 10mA setting, $V_{OUT} = V_{IN}$	$T_A = +25^{\circ}C$	-2	± 0.3	+2	%
		$T_A = 0^{\circ}C$ to $+85^{\circ}C$	-5		+5	
		$T_A = -40^{\circ}C$ to $+85^{\circ}C$	-8		+8	
	3/32 setting, $T_A = +25^{\circ}C$		± 7			
Current Regulator Dropout	10mA setting (Note 2)		30	125	mV	
Leakage in Shutdown	$T_A = +25^{\circ}C$		0.01	5	μA	
	$T_A = +85^{\circ}C$		0.1			
Open-LED Detection Threshold	LED_ enabled		100		mV	
Shorted-LED Detection Threshold	LED_ enabled		$V_{OUT} - 1V$		V	

Note 1: All devices are 100% production tested at $T_A = +25^{\circ}C$. Limits over the operating temperature range are guaranteed by design.

Note 2: LED current sink dropout voltage is defined as the voltage at which current drops 10% from the current level measured at 0.6V.

Note 3: Flash duration is from rising edge of FLEN until I_{FLED} turns off (or returns to the movie current setting if MVON is high).

Note 4: The MAX8830 step-up converter IN supply current is tested in an open-loop configuration with no inductor. Actual closed-loop IN supply current is higher due to conduction losses in the inductor and LX nFET and pFET. These additional losses are highly dependent on inductor value and series resistance.

LED Light Management IC in 2.5mm x 2.5mm UCSP

Typical Operating Characteristics

($V_{IN} = 3.6V$, $V_{OUT} = 3.8V$, $V_{DD} = 3.0V$, circuit of Figure 1, $T_A = +25^\circ C$, unless otherwise noted.)

MAX8830

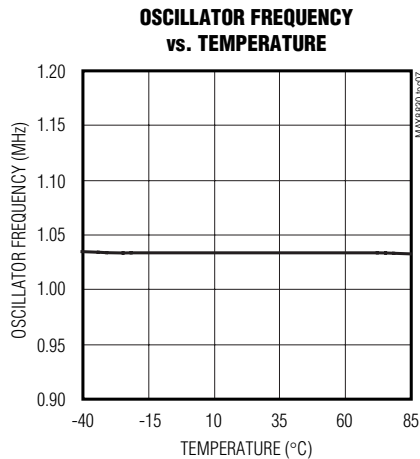
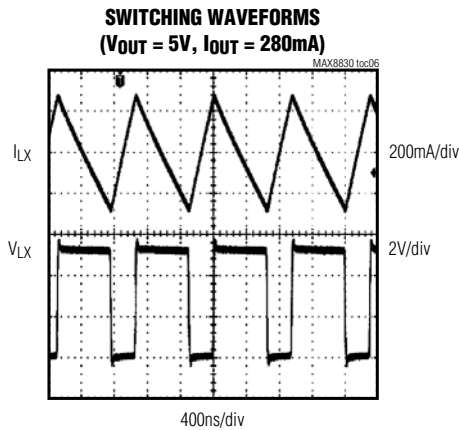
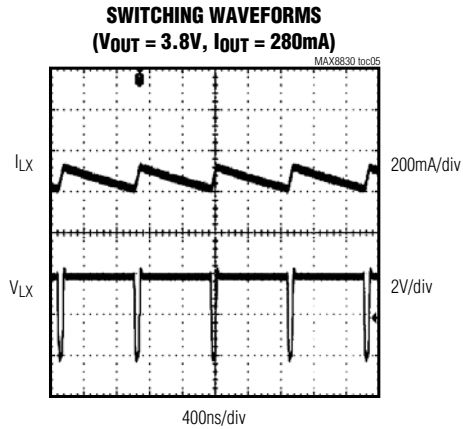
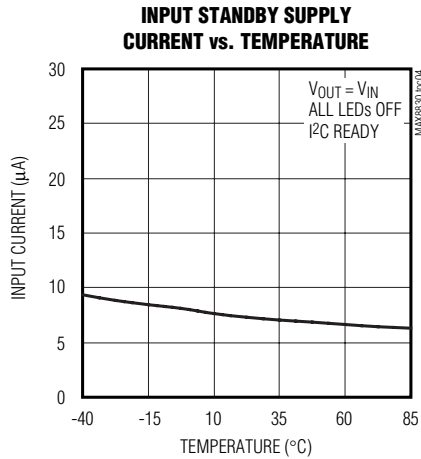
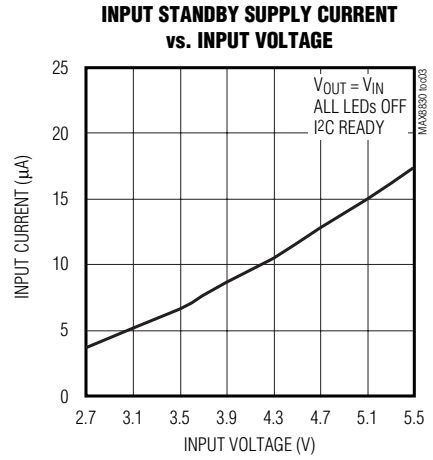
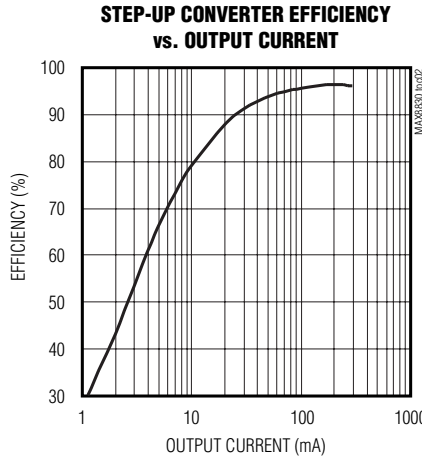
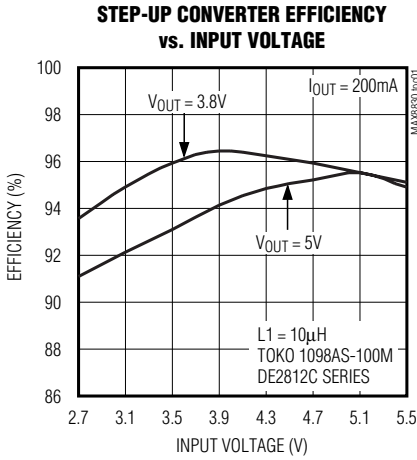

LED Light Management IC in 2.5mm x 2.5mm UCSP

Typical Operating Characteristics (continued)

($V_{IN} = 3.6V$, $V_{OUT} = 3.8V$, $V_{DD} = 3.0V$, circuit of Figure 1, $T_A = +25^\circ C$, unless otherwise noted.)

OSCILLATOR FREQUENCY vs. INPUT VOLTAGE

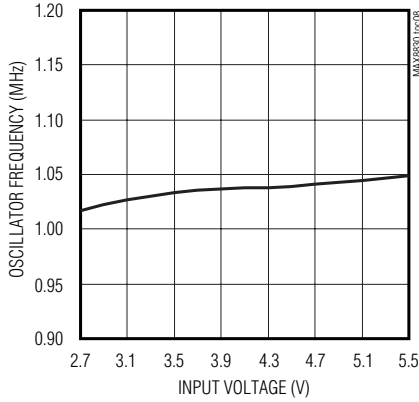

OUTPUT VOLTAGE vs. TEMPERATURE

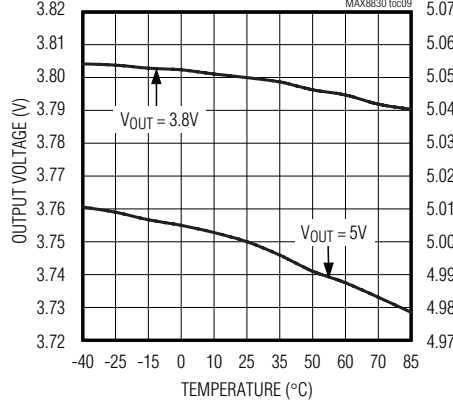

LED CURRENT ACCURACY AND MATCHING vs. INPUT VOLTAGE ($I_{LED} = 10mA$)

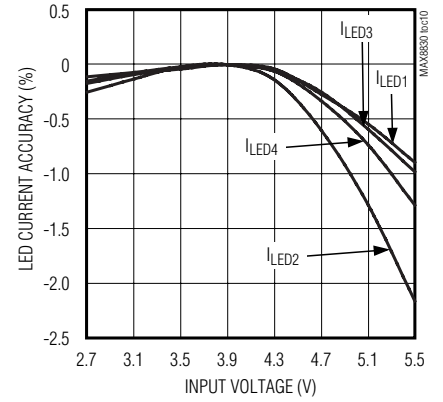

LED CURRENT ACCURACY vs. TEMPERATURE

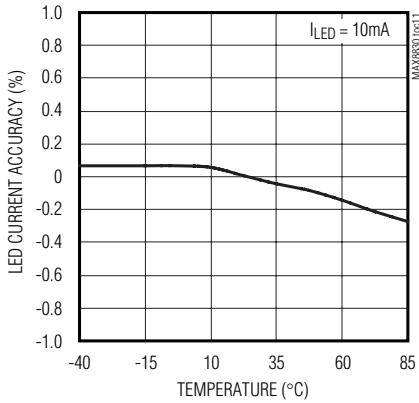

FLED CURRENT-REGULATOR DROPOUT VOLTAGE vs. FLED CURRENT

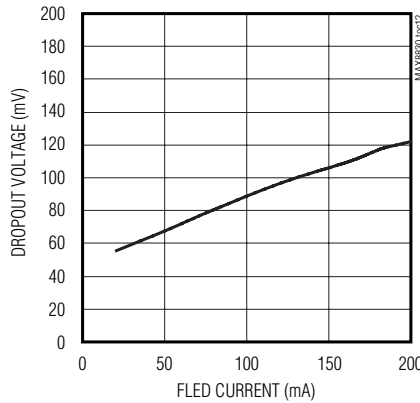

LED CURRENT-REGULATOR DROPOUT VOLTAGE vs. LED CURRENT

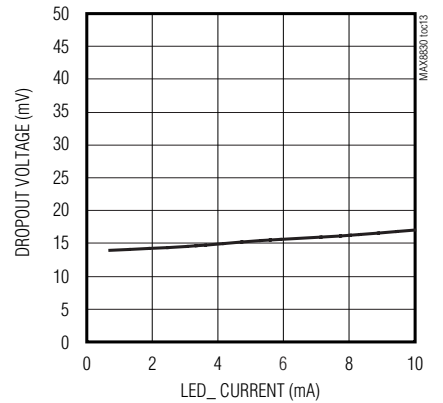

STARTUP WAVEFORMS

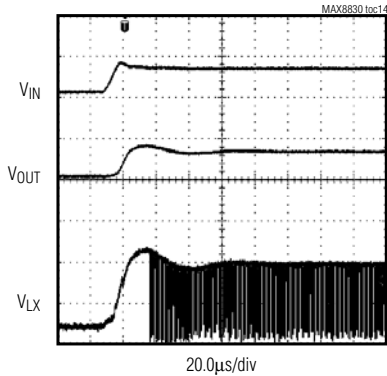

SOFT-START

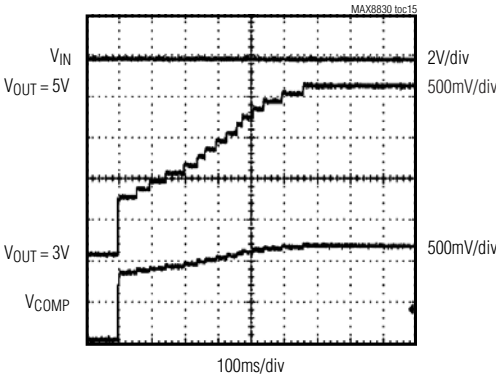

STEP-UP DC/DC IN SUPPLY CURRENT

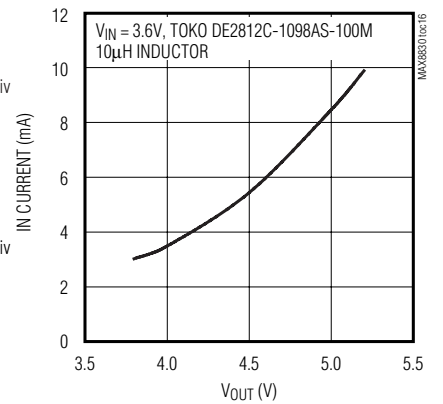

LED Light Management IC in 2.5mm x 2.5mm UCSP

Pin Description

MAX8830

UCSP BUMP	NAME	FUNCTION
A1	FLED	Flash LED Current-Sink Regulator. Current flowing into FLED is based on the internal I ² C registers. Connect FLED to the cathode of an external flash LED or LED module. FLED is high impedance during shutdown. If unused, FLED may be shorted to ground or left unconnected.
A2	PGND	Power Ground. Connect PGND to GND and to the input capacitor ground. Connect PGND to the PCB ground plane.
A3	LX	Inductor Connection. Connect LX to the switched side of the inductor. LX is internally connected to the drains of the internal MOSFETs. LX is high impedance in shutdown.
A4	OUT	Regulator Output. Connect OUT to the anodes of the external LEDs. OUT can also be used to supply other circuits, such as audio amplifiers. Bypass OUT to PGND with a 10μF or larger ceramic capacitor. During shutdown, V _{OUT} is one diode drop below the V _{IN} .
C1 B1 B2 D1	LED1 LED2 LED3 LED4	LED Current-Sink Regulators. Current flowing into LED_ is based on the internal I ² C registers. Connect LED_ to the cathodes of external LEDs. LED_ is high impedance during shutdown. If unused, LED_ can be shorted to ground or left unconnected.
B3	MVON	Movie On Logic Input. Connect to V _{DD} or drive with logic 1 to enable the movie mode. The FLED movie current is set in the I ² C registers. Connect to GND or drive with logic 0 to turn off the movie mode. The movie mode is also enabled through the I ² C interface.
B4	IN	Analog Supply Voltage Input. The input voltage range is 2.7V to 5.5V. Bypass IN to GND and PGND with a 10μF ceramic capacitor as close as possible to the IC. IN is high impedance during shutdown.
C2	FLEN	Flash Enable Logic Input. A transition from logic 0 to logic 1 on FLEN initiates the flash mode. The flash duration and FLED flash current are set in I ² C registers. The flash mode terminates when either FLEN transitions back to logic 0 or after the flash-duration timer expires.
C3	SCL	I ² C Clock Input. Data is read on the rising edge of SCL.
C4	COMP	Compensation Input. See the <i>COMP Network Selection</i> section for details.
D2	GND	Analog Ground. Connect GND to PGND and to the input capacitor ground. Connect GND to the PCB ground plane.
D3	SDA	I ² C Data Input. Data is read on the rising edge of SCL.
D4	V _{DD}	Logic Input Supply Voltage. Connect V _{DD} to the logic supply driving SCL, SDA, MVON, and FLEN. Bypass V _{DD} to GND with a 0.1μF ceramic capacitor. Setting V _{DD} = 0 places the part in shutdown.

LED Light Management IC in 2.5mm x 2.5mm UCSP

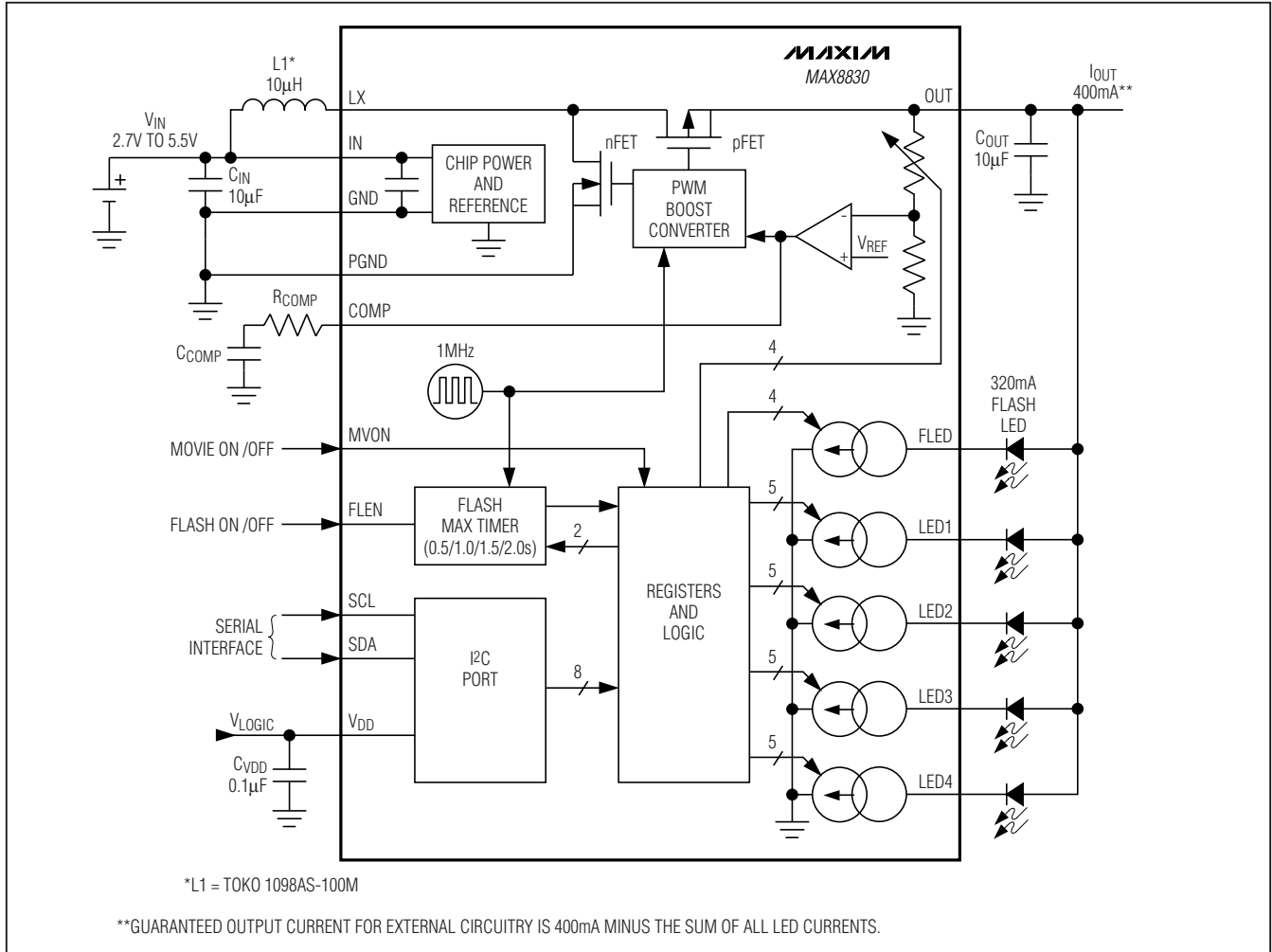

Figure 1. Block Diagram and Typical Application Circuit

Detailed Description

The MAX8830 light management IC integrates a 400mA PWM step-up DC-DC converter, a 320mA white LED camera flash current sink, and four programmable LED current sinks. An I²C interface controls individual on/off of all outputs, step-up output voltage setting, movie/flash current and flash timer-duration settings, and individual current sink settings. Figure 1 shows the block diagram and typical application circuit.

Step-Up Converter (LX, OUT, COMP, PGND)

The MAX8830 includes a fixed-frequency, PWM step-up converter that supplies power to the LEDs and additional loads, such as audio amplifiers. The output voltage is programmable from 3.8V to 5.2V (in 100mV steps) through the I²C port. If the output voltage is not programmed, the step-up converter remains off; however, if any of the current regulators are programmed, the boost converter p-channel synchronous rectifier is turned on. The step-up converter switches an internal power MOSFET and synchronous rectifier at a constant 1MHz frequency with varying duty cycle up to 75% to maintain constant output voltage as V_{IN} and load vary. Internal circuitry prevents any unwanted subharmonic switching by forcing a minimum 4% duty cycle.

LED Light Management IC in 2.5mm x 2.5mm UCSP

Flash Current-Sink Regulator (FLED, MVON, FLEN)

A low-dropout linear current regulator from FLED to PGND sinks current from an external flash LED cathode terminal. The FLED current is regulated to I²C-programmable levels for movie mode (up to 160mA) and flash mode (up to 320mA). The movie mode provides continuous lighting when enabled through I²C (see Table 1). The flash mode is enabled only when FLEN goes high. A flash maximum timer, programmable from 0.5s to 2.0s through I²C, limits the duration of the flash mode in case FLEN remains high. The flash mode has priority over the movie mode.

Current-Sink Regulators (LED1–LED4)

Four low-dropout linear current regulators from LED_n to GND sink current from external LED cathode terminals. The LED_n currents are individually regulated to an I²C-programmable level from off to 10mA in 32 steps, independently set for each LED_n.

Undervoltage Lockout

The IC contains undervoltage lockout (UVLO) circuitry that disables the device until V_{IN} is greater than 2.45V (typ). Once V_{IN} rises above 2.45V (typ), the UVLO circuitry does not disable the IC until V_{IN} falls below the UVLO threshold hysteresis.

Soft-Start

The MAX8830 soft-starts by charging C_{COMP} with a 100μA current source. During this time, the internal MOSFET is switching at the minimum duty cycle. Once V_{COMP} rises above 1V, the duty cycle increases until the output voltage reaches the desired regulation level. COMP is pulled to GND with a 80Ω internal resistor during UVLO or shutdown. See the *Typical Operating Characteristics* for an example of soft-start operation.

Shutdown and Standby

The MAX8830 is in shutdown when V_{DD} = 0. In shutdown, supply current is reduced to 0.1μA (typ). The MAX8830 is in standby when the step-up converter and all LED outputs are turned off through I²C (and by keeping MVON and FLEN at logic 0). During this time, the I²C port remains in standby (ready) state as long as logic-high voltage is supplied to V_{DD}.

C_{COMP} is discharged whenever the step-up converter is turned off, allowing the device to reinitiate soft-start when it is enabled. The internal MOSFET and synchronous rectifier are also high impedance when the step-up converter is off; however, OUT is one diode drop below the input. FLED and LED_n are high impedance in shutdown, so the external LEDs are all off, but any external circuitry on OUT (such as an audio amplifier) is not disconnected, and therefore, should include its own shutdown capability.

Parallel Connection of Current-Sink Regulators

The LED current-sink regulators (FLED and LED_n) can be connected in parallel in any combination to allow the use of higher current LEDs or any other desired effects. Unused current regulators may be left unconnected or shorted to ground. The LED regulators must be disabled through I²C to avoid a fault detection from an open or short.

Open/Short LED Detection

The MAX8830 includes 10 comparators to detect open or shorted LEDs on the FLED and LED1–LED4 pins. One comparator on each pin detects when the voltage falls below 100mV, indicating an open LED fault. Another comparator on each pin detects when the voltage rises above V_{OUT} - 1V, indicating a shorted LED fault. The fault-detection comparators are enabled only when the corresponding current sink is enabled (and not set to zero current). Once a fault is detected the two comparators provide a single bit output (1 = fault, 0 = no fault) corresponding to the appropriate pin. When a read command (address 0x95) is issued to the MAX8830, the status of each pin is latched into the status register (see Table 6) and subsequently written to the I²C bus by the MAX8830.

Thermal Shutdown

Thermal shutdown limits total power dissipation in the MAX8830. When the junction temperature exceeds +160°C, the device turns off, allowing the IC to cool. The IC turns on and begins soft-start after the junction temperature cools by 20°C. This results in a pulsed output during continuous thermal-overload conditions.

LED Light Management IC in 2.5mm x 2.5mm UCSP

I²C Serial Interface

The step-up converter OUT voltage, FLED flash current and duration, FLED movie current, and LED_ individual currents are set using the I²C serial interface. Each current level is individually programmable (including off) with a single command (see Tables 1, 2, and 3). While the flash current is set through I²C, current does not flow until the FLEN input is logic 1, as described in the *Flash Current-Sink Regulator (FLED, MVON, FLEN)* section. By default, the movie current is turned on when a nonzero setting is programmed through I²C. Alternately, by setting a bit in the “other” register, the movie mode current may also be gated by logic 1 at the MVON input.

The I²C serial interface consists of a serial-data line (SDA) and a serial-clock line (SCL). Standard I²C write-byte commands are used. Figure 2 shows a timing diagram for the I²C protocol. The MAX8830 is a slave-only device, relying upon a master to generate a clock signal. The master (typically a microprocessor) initiates data transfer on the bus and generates SCL to permit data transfer. A master device communicates to the MAX8830 by transmitting the proper 8-bit address (0x94) followed by the 8-bit control byte. Each 8-bit control byte consists of a command code (usually 3-bits) with the remaining bits (usually 5 bits) as data (see Table 1). Each transmit sequence is framed by a START (A) condition and a STOP (L) condition. Each word transmitted over the bus is 8 bits long and is always followed by an acknowledge clock pulse.

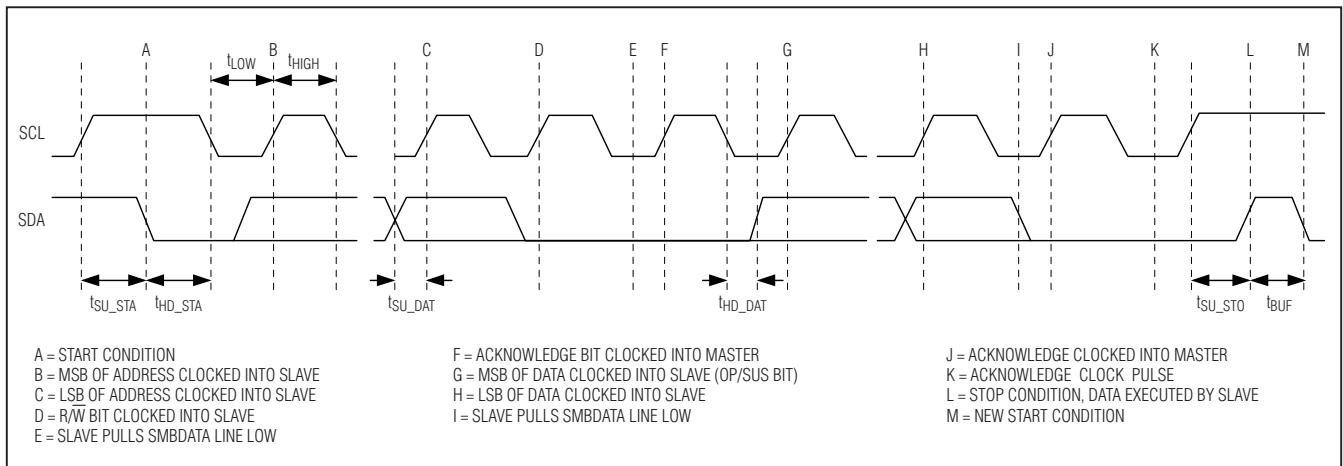

Figure 2. I²C Timing Diagram

LED Light Management IC in 2.5mm x 2.5mm UCSP

MAX8830

Table 1. Control Data Byte

FUNCTION	SDA CONTROL BYTE							
	COMMAND			DATA				
	C2	C1	C0	D4	D3	D2	D1	D0
Step-Up OUT Voltage	0	0	0	0	3.8V to 5.2V and off in 16 steps			
Unused	0	0	0	0	Reserved for future use			
LED1 Current	0	0	1	0	Off to 10mA in 32 steps			
LED2 Current	0	1	0	0	Off to 10mA in 32 steps			
LED3 Current	0	1	1	0	Off to 10mA in 32 steps			
LED4 Current	1	0	0	0	Off to 10mA in 32 steps			
Unused	1	0	1	0	Reserved for future use			
Flash Current	1	1	0	Off to 320mA in 32 steps				
Movie Current	1	1	1	0	Off to 160mA in 16 steps			
Other	1	1	1	1	0	MVON enable	Flash duration	

Note: C2 is MSB and D0 is LSB.

Table 2. Control Register Data Default Settings

FUNCTION	SDA CONTROL BYTE							
	COMMAND			DATA				
	C2	C1	C0	D4	D3	D2	D1	D0
Step-Up OUT Voltage	0	0	0	0	Off (0000)			
Unused	0	0	0	0	Reserved for future use			
LED1 Current	0	0	1	0	Off (00000)			
LED2 Current	0	1	0	0	Off (00000)			
LED3 Current	0	1	1	0	Off (00000)			
LED4 Current	1	0	0	0	Off (00000)			
Unused	1	0	1	0	Reserved for future use			
Flash Current	1	1	0	Off (00000)				
Movie Current	1	1	1	0	Off (0000)			
Other	1	1	1	1	0	MV by I ² C (0)	0.5s (00)	

Note: C2 is MSB and D0 is LSB.

LED Light Management IC in 2.5mm x 2.5mm UCSP

Table 3. Step-Up Voltage and LED Current Settings

OUT VOLTAGE (V) OR LED CURRENT (mA)							DATA				
OUT	LED1	LED2	LED3	LED4	FLASH	MOVIE	D4	D3	D2	D1	D0
OFF	OFF	OFF	OFF	OFF	OFF	OFF	0	0	0	0	0
3.8	0.63	0.63	0.63	0.63	20	20	0	0	0	0	1
3.9	0.94	0.94	0.94	0.94	30	30	0	0	0	1	0
4.0	1.25	1.25	1.25	1.25	40	40	0	0	0	1	1
4.1	1.56	1.56	1.56	1.56	50	50	0	0	1	0	0
4.2	1.88	1.88	1.88	1.88	60	60	0	0	1	0	1
4.3	2.19	2.19	2.19	2.19	70	70	0	0	1	1	0
4.4	2.50	2.50	2.50	2.50	80	80	0	0	1	1	1
4.5	2.81	2.81	2.81	2.81	90	90	0	1	0	0	0
4.6	3.13	3.13	3.13	3.13	100	100	0	1	0	0	1
4.7	3.44	3.44	3.44	3.44	110	110	0	1	0	1	0
4.8	3.75	3.75	3.75	3.75	120	120	0	1	0	1	1
4.9	4.06	4.06	4.06	4.06	130	130	0	1	1	0	0
5.0	4.38	4.38	4.38	4.38	140	140	0	1	1	0	1
5.1	4.69	4.69	4.69	4.69	150	150	0	1	1	1	0
5.2	5.00	5.00	5.00	5.00	160	160	0	1	1	1	1
	5.31	5.31	5.31	5.31	170		1	0	0	0	0
	5.63	5.63	5.63	5.63	180		1	0	0	0	1
	5.94	5.94	5.94	5.94	190		1	0	0	1	0
	6.25	6.25	6.25	6.25	200		1	0	0	1	1
	6.56	6.56	6.56	6.56	210		1	0	1	0	0
	6.88	6.88	6.88	6.88	220		1	0	1	0	1
	7.19	7.19	7.19	7.19	230		1	0	1	1	0
	7.50	7.50	7.50	7.50	240		1	0	1	1	1
	7.81	7.81	7.81	7.81	250		1	1	0	0	0
	8.13	8.13	8.13	8.13	260		1	1	0	0	1
	8.44	8.44	8.44	8.44	270		1	1	0	1	0
	8.75	8.75	8.75	8.75	280		1	1	0	1	1
	9.06	9.06	9.06	9.06	290		1	1	1	0	0
	9.38	9.38	9.38	9.38	300		1	1	1	0	1
	9.69	9.69	9.69	9.69	310		1	1	1	1	0
	10.00	10.00	10.00	10.00	320		1	1	1	1	1

Note: Defaults in **bold italics**.

LED Light Management IC in 2.5mm x 2.5mm UCSP

MAX8830

Table 4 lists the MVON control settings; Table 5 lists flash duration settings. Table 6 shows the read (0x95) status register.

UCSP Applications Information

For the latest application details on UCSP construction, dimensions, tape carrier information, PCB techniques, bump-pad layout, and recommended reflow temperature profile, as well as the latest information on reliability testing results, go to the Maxim website at www.maxim-ic.com/ucsp for the Application Note: *UCSP-A Wafer-Level Chip-Scale Package*.

Table 4. MVON Control Setting

FUNCTION	SDA CONTROL BYTE							
	COMMAND			DATA				
	C2	C1	C0	D4	D3	D2	D1	D0
<i>Movie Enabled Through I²C</i>	1	1	1	1	X	0	X	X
Movie Enabled Through MVON Pin	1	1	1	1	X	1	X	X

Note: Defaults in ***bold italics***.

Table 5. Flash Duration Settings

FUNCTION	SDA CONTROL BYTE							
	COMMAND			DATA				
	C2	C1	C0	D4	D3	D2	D1	D0
<i>0.5s Flash</i>	1	1	1	1	X	X	0	0
1.0s Flash	1	1	1	1	X	X	0	1
1.5s Flash	1	1	1	1	X	X	1	0
2.0s Flash	1	1	1	1	X	X	1	1

Note: Defaults in ***bold italics***.

Table 6. Read (0x95) Status Register

FUNCTION	SDA READ BYTE							
	DATA							
	D7	D6	D5	D4	D3	D2	D1	D0
Fault Status	X	X	X	FLED	LED4	LED3	LED2	LED1

Note: 1 = fault, 0 = no fault

LED Light Management IC in 2.5mm x 2.5mm UCSP

Table 7. Suggested Inductors

MANUFACTURER	SERIES	INDUCTANCE (μH)	DCR (mΩ)	ISAT (A)	DIMENSIONS (L _{TYP} x W _{TYP} x H _{MAX} = VOLUME)
Cooper (Coiltronics)	SD3114	2.2	110	1.74	3.0 x 3.0 x 1.45 = 13mm ³
FDK	MIPF2520	2.2	80	1.3A	2.5 x 2.0 x 1.0 = 5mm ³
	MIPW3226	2.2	100	1.1	3.2 x 2.6 x 1.0 = 8mm ³
TDK	VLF3012AT	2.2	88	1.0	2.8 x 2.6 x 1.2 = 9mm ³
		10	360	0.49	
TOKO	DE2812C	2.7	75	1.8	3.0 x 3.2 x 1.2 = 12mm ³
		10	325	0.78	3.0 x 3.2 x 1.2 = 12mm ³

Inductor Selection

The MAX8830 is designed to use a 2.2μH to 10μH inductor. To prevent core saturation, ensure that the inductor-saturation current rating exceeds the peak inductor current for the application. Calculate the worst-case peak inductor current with the following formula:

$$I_{PEAK} = \frac{V_{OUT} \times I_{OUT(MAX)}}{0.9 \times V_{IN(MIN)}} + \frac{V_{IN(MIN)} \times 0.5\mu s}{2 \times L}$$

Table 7 provides a list of suggested inductors.

Capacitor Selection

Bypass the input to GND and PGND using a ceramic capacitor. A ceramic capacitor with X5R and X7R dielectrics are recommended for their low ESR and tighter tolerances over a wide temperature range. Place the capacitor as close as possible to the IC. The recommended minimum value for the input capacitor is 10μF; however, larger value capacitors can be used to reduce input ripple at the expense of size and higher cost.

The output capacitance required depends on the maximum output current. A 10μF ceramic capacitor works well in most situations, but a 4.7μF capacitor is acceptable for lower load currents.

COMP Network Selection

The step-up converter is compensated for stability through an external compensation network from COMP to GND. See Table 8 for recommended compensation components.

Table 8. Suggested Compensation Networks

	R _{COMP} (kΩ)	C _{COMP} (pF)
2.2μH Inductor (Dynamic Loads)	4.3	2200
4.7μH Inductor (Dynamic Loads)	3	4700
10μH Inductor (Dynamic Loads)	3	6800
Only LED Loads (2.2μH to 10μH)	0 (short)	22000

PCB Layout

Due to fast switching waveforms and high-current paths, careful PCB layout is required. Connect GND and PGND directly to the ground plane. The IN bypass capacitor should be placed as close as possible to the IC. R_{COMP} and C_{COMP} should be connected between COMP and GND as close as possible to the IC. Minimize trace lengths between the IC and the inductor, the input capacitor, and the output capacitor; keep these traces short, direct, and wide. The ground connections of C_{IN} and C_{OUT} should be as close together as possible and connected to PGND. The traces from the input to the inductor and from the output capacitor to the LEDs may be longer. A sample layout is available in the MAX8830 evaluation kit.

Pin Configuration

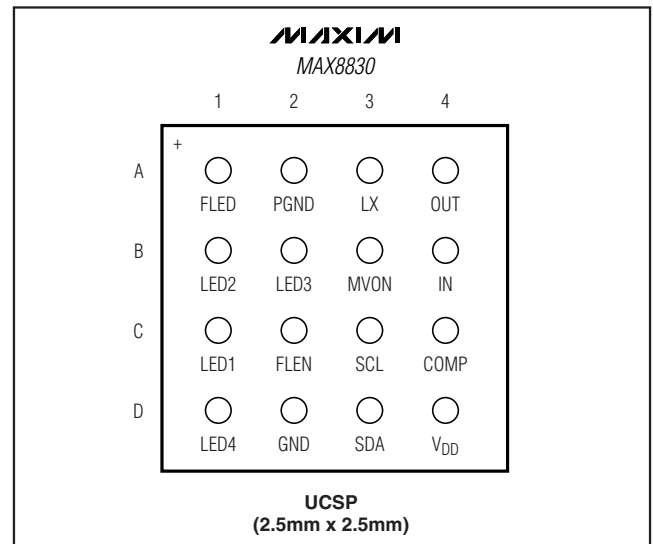

Chip Information

PROCESS: BiCMOS

LED Light Management IC in 2.5mm x 2.5mm UCSP

Package Information

For the latest package outline information and land patterns, go to www.maxim-ic.com/packages.

PACKAGE TYPE	PACKAGE CODE	DOCUMENT NO.
16 UCSP	W162A2-1	21-0202

MAX8830

LED Light Management IC in 2.5mm x 2.5mm UCSP

Revision History

REVISION NUMBER	REVISION DATE	DESCRIPTION	PAGES CHANGED
0	4/07	Initial release	—
1	6/08	Updated several electrical characteristics	1-4, 6, 8, 9, 11, 12, 15

Maxim cannot assume responsibility for use of any circuitry other than circuitry entirely embodied in a Maxim product. No circuit patent licenses are implied. Maxim reserves the right to change the circuitry and specifications without notice at any time.

Maxim Integrated Products, 120 San Gabriel Drive, Sunnyvale, CA 94086 408-737-7600 _____ 16