

Power Schottky Rectifier - 10Amp 100Volt

Features

- Plastic package has Underwriters Laboratory Flammability Classifications 94V-0
- High Junction Temperature Capability
- Low forward voltage, high current capability
- High surge capacity
- Low power loss, high efficiency
- ESD performance human body mode > 8 KV

Application

- AC/DC Switching Adaptor and other Switching Power Supply

Absolute maximum ratings

Symbol	Ratings	Unit	Conditions
IF(AV)	10	A	Average Forward Current
VRRM	100	V	Repetitive Peak Reverse Voltage
IFSM	120	A	Peak Forward Surge Current
VF	0.66	V	Forward Voltage Drop
Tj, Tstg	-50 to +175	°C	Operating and Storage Temperature

Electrical characteristics

Parameters	Symbol	Ratings	Conditions
Maximum Instantaneous Forward Voltage	VF	0.82V	Per Leg at IF = 10A Tc = 25°C
		0.66V	Tc = 125°C
Maximum Reverse Leakage Current	IR	0.05mA	Per Leg at VR = 100V Tc = 25°C
		10mA	Tc = 125°C
Typical Thermal Resistance,Junction to Case	Rθ(j-c)	2.2 °C/W	Per Leg TO-220AC
		4.5 °C/W	ITO-220AC

June 2012 / Rev.6.8

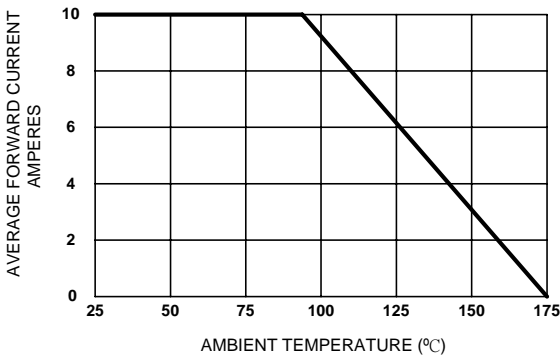

Figure 1. Forward Current Derating Curve

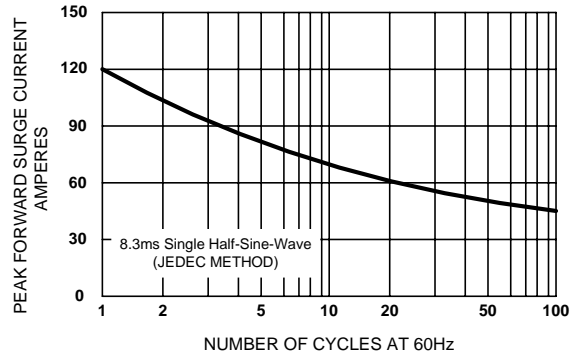

Figure 2. Maximum Non-repetitive Surge Current

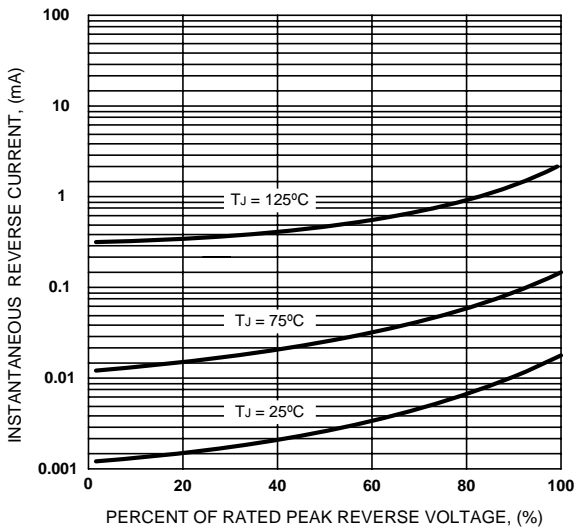

Figure 3. Typical Reverse Characteristics

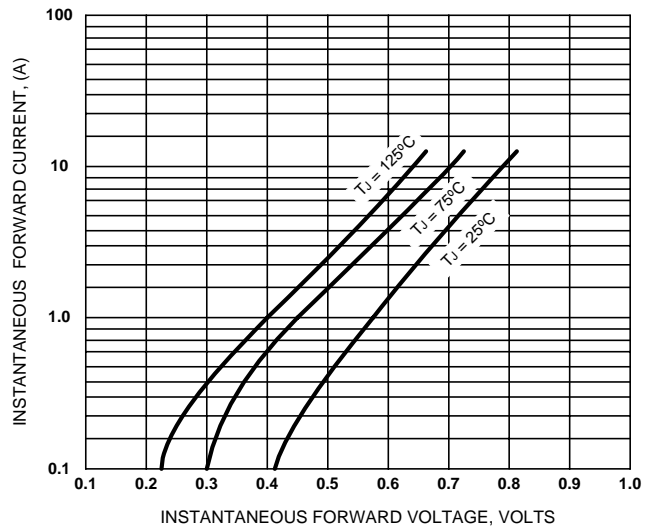

Figure 4. Typical Forward Characteristics

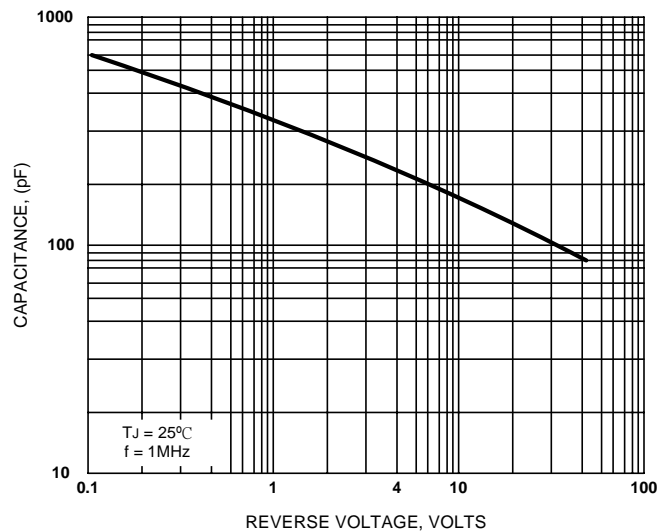
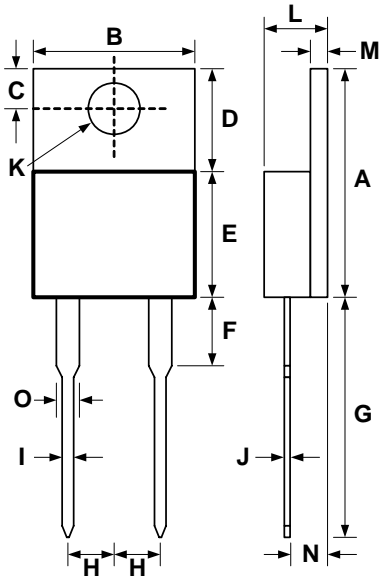

Figure 5. Typical Junction Capacitance

MBR10100C

TO-220AC



DIM	DIMENSIONS				NOTE
	INCHES		MM		
	MIN	MAX	MIN	MAX	
A	.579	.606	14.70	15.40	
B	.392	.411	9.95	10.45	
C	.104	.116	2.65	2.95	
D	.248	.272	6.30	6.90	
E	.325	.350	8.25	8.90	
F	.126	.157	3.20	4.00	
G	.492	.551	12.50	14.00	
H	.096	.108	2.45	2.75	
I	.028	.039	0.70	1.00	
J	.010	.022	0.25	0.55	
K	.146	.157	3.70	4.00	
L	.167	.187	4.25	4.75	
M	.045	.057	1.15	1.45	
N	.089	.114	2.25	2.90	
O	.047	.055	1.20	1.40	

MBR10100FC

ITO-220AC

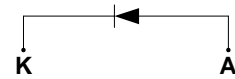
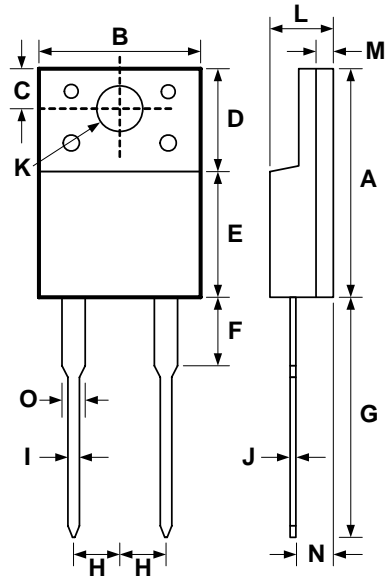

DIM	DIMENSIONS				NOTE
	INCHES		MM		
	MIN	MAX	MIN	MAX	
A	.577	.600	14.65	15.25	
B	.386	.406	9.80	10.30	
C	.098	.114	2.50	2.90	
D	.258	.274	6.55	6.95	
E	.315	.331	8.00	8.40	
F	.110	.161	2.80	4.10	
G	.508	.571	12.90	14.50	
H	.089	.106	2.25	2.70	
I	.020	.033	0.50	0.85	
J	.020	.028	0.50	0.70	
K	.120	.138	3.05	3.50	
L	.169	.185	4.30	4.70	
M	.051	.063	1.30	1.60	
N	.079	.112	2.00	2.85	
O	.043	.055	1.10	1.40	