

# MBR20H100CT

Rev.F Mar.-2016

## 描述 / Descriptions

TO-220 塑封封装 肖特基二极管。

Schottky Barrier Diode in a TO-220 Plastic Package.

## 特征 / Features

损耗低，效率高。

Low power loss, high efficiency.

## 用途 / Applications

用于高频、低压、大电流整流二极管，续流二极管，保护二极管。

For use in low voltage, high frequency inverters, free wheeling, and polarity protection applications.

## 内部等效电路 / Equivalent Circuit

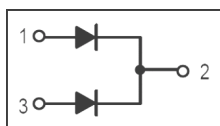

## 引脚排列 / Pinning

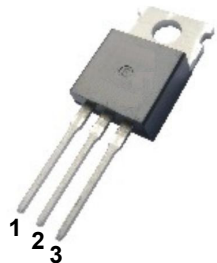

PIN1 : Anode

PIN 2 : Cathode

PIN 3 : Anode

## 放大及印章代码 / $h_{FE}$ Classifications & Marking

见印章说明。 See Marking Instructions.

**极限参数 / Absolute Maximum Ratings(Ta=25°C)**

参数 Parameter	符号 Symbol	数值 Rating	单位 Unit
Peak Repetitive Reverse Voltage	$V_{RRM}$	100	V
RMS Forward Current	$I_{F(RMS)}$	30	A
Average Forward Current	$I_{F(AV)}$	10	A
	$I_{F(AV)}(total)$	20	A
Non Repetitive Peak Surge Forward Current	$I_{FSM}$	250	A
Repetitive Peak Reverse Current	$I_{RRM}$	1.0	A
Non Repetitive Peak Reverse Current	$I_{RSM}$	3.0	V
Thermal Resistance Junction to Case	$R_{\theta Jc}$	1.6	°C/W
Junction Temperature Range	$T_j$	175	°C
Storage Temperature Range	$T_{stg}$	-55~175	°C

**电性能参数 / Electrical Characteristics(Ta=25°C)**

参数 Parameter	符号 Symbol	测试条件 Test Conditions	最小值 Min	典型值 Typ	最大值 Max	单位 Unit	
Forward Voltage	$V_F$	$I_F = 8A(T_j = 25^\circ C)$			0.71	V	
		$I_F = 8A(T_j = 125^\circ C)$		0.56	0.58	V	
		$I_F = 10A(T_j = 25^\circ C)$				0.77	V
		$I_F = 10A(T_j = 125^\circ C)$			0.59	0.64	V
		$I_F = 16A(T_j = 25^\circ C)$				0.81	V
		$I_F = 16A(T_j = 125^\circ C)$			0.65	0.68	V
		$I_F = 20A(T_j = 25^\circ C)$				0.88	V
		$I_F = 20A(T_j = 125^\circ C)$			0.67	0.73	V
Instantaneous Reverse Current	$I_R$	$V_R = 100V(T_j = 25^\circ C)$			4.5	uA	
		$V_R = 100V(T_j = 125^\circ C)$		2.0	6.0	mA	
Critical rate of rise of reverse voltage	dv/dt				10000	V/μs	

**电参数曲线图 / Electrical Characteristic Curve**

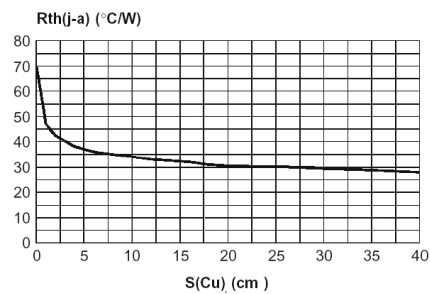
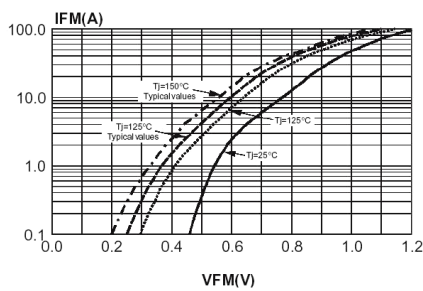
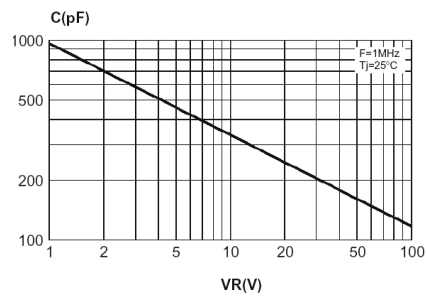
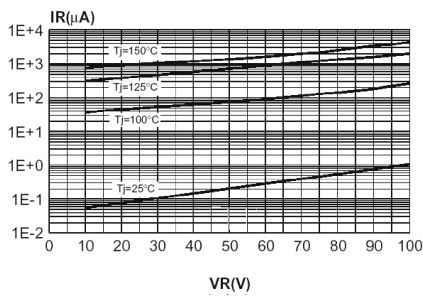
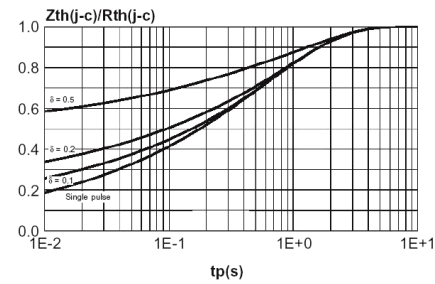
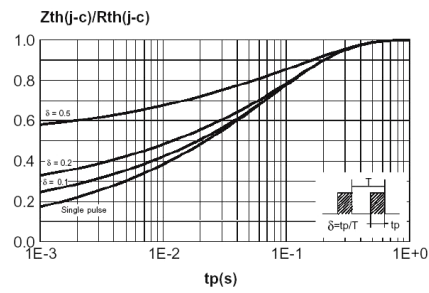
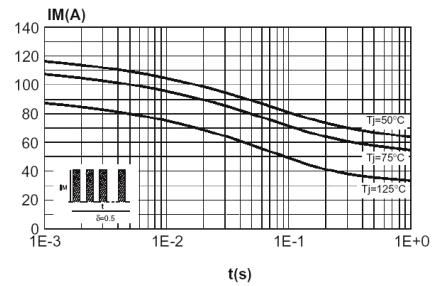
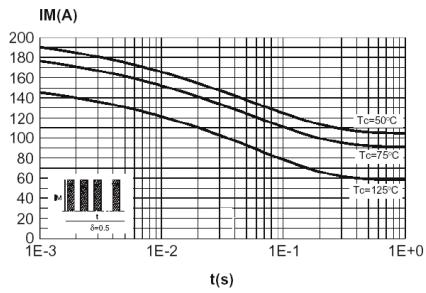
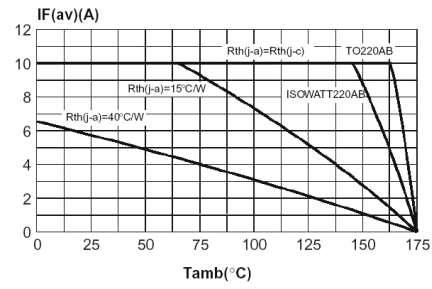
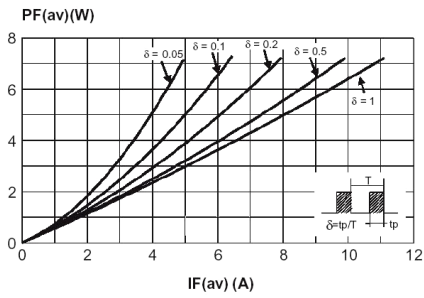

外形尺寸图 / Package Dimensions

TO-220

单位: mm

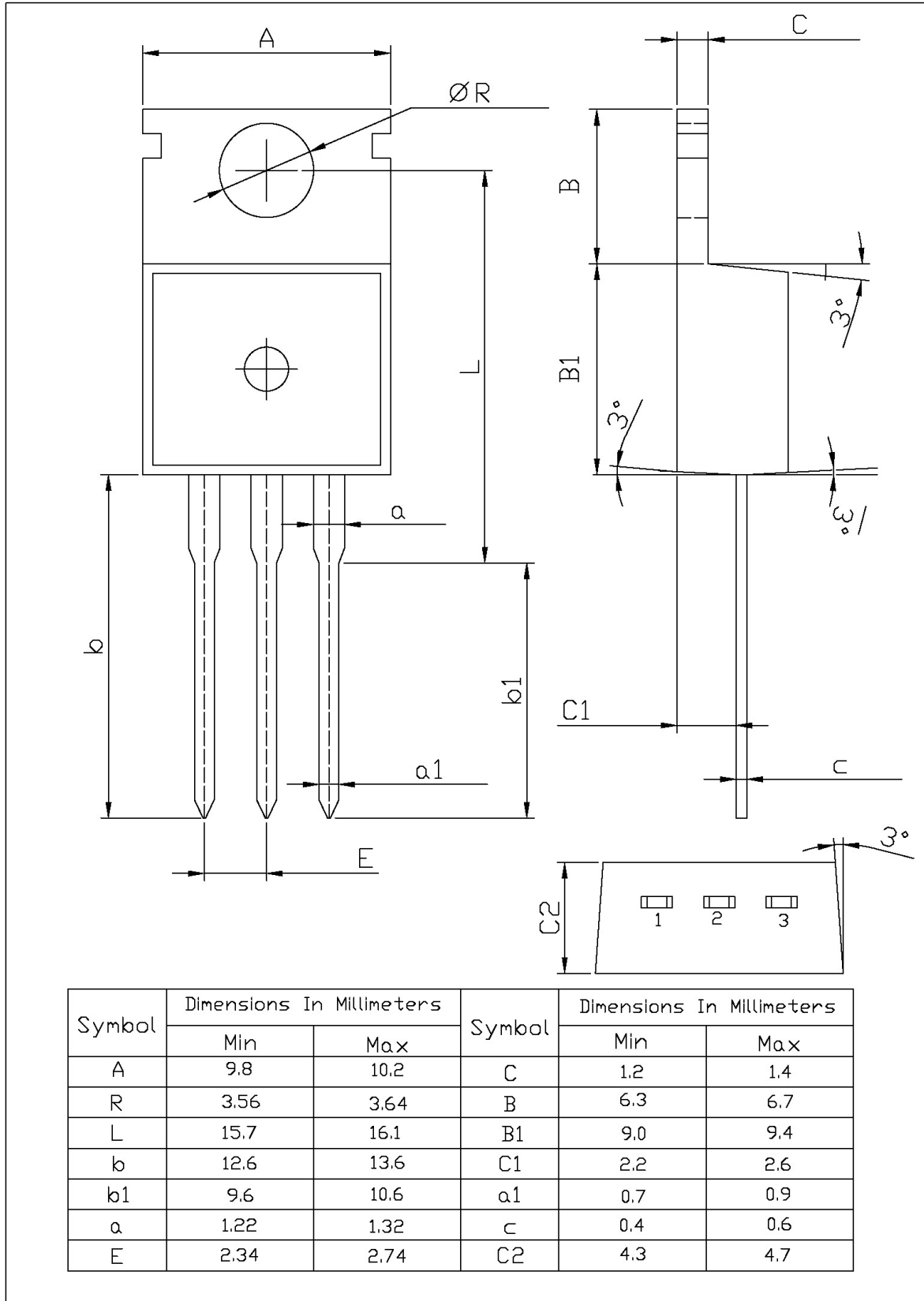

## 印章说明 / Marking Instructions

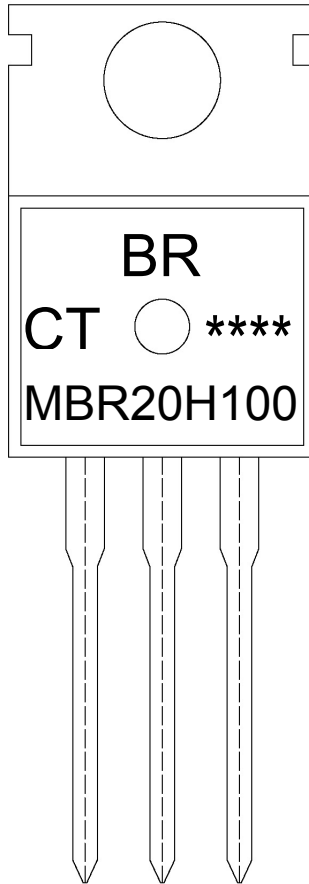

说明：

BR： 为公司代码

MBR20H100： 为产品型号

CT： 为内部结构

\*\*\*\*： 为生产批号代码，随生产批号变化。

Note:

BR: Company Code

MBR20H100 : Product Type.

CT: Internal Structure

\*\*\*\*: Lot No. Code, code change with Lot No.

**波峰焊温度曲线图(无铅) / Temperature Profile for Dip Soldering(Pb-Free)**



说明：

- 1、预热温度 25 ~ 150°C，时间 60 ~ 90sec;
- 2、峰值温度 255±5°C，时间持续为 5±0.5sec;
- 3、焊接制程冷却速度为 2 ~ 10°C/sec.

Note:

- 1.Preheating:25~150°C, Time:60~90sec.
- 2.Peak Temp.:255±5°C, Duration:5±0.5sec.
3. Cooling Speed: 2~10°C/sec.

**耐焊接热试验条件 / Resistance to Soldering Heat Test Conditions**

温度：270±5°C

时间：10±1 sec.

Temp.:270±5°C

Time:10±1 sec

**包装规格 / Packaging SPEC.**

散件包装 / BULK

Package Type 封装形式	Units 包装数量					Dimension 包装尺寸 (unit: mm <sup>3</sup> )		
	Units/Bag 只/袋	Bags/Inner Box 袋/盒	Units/Inner Box 只/盒	Inner Boxes/Outer Box 盒/箱	Units/Outer Box 只/箱	Bag 袋	Inner Box 盒	Outer Box 箱
TO-220/F	200	10	2,000	5	10,000	135×190	237×172×102	560×245×195

套管包装 / TUBE

Package Type 封装形式	Units 包装数量					Dimension 包装尺寸 (unit: mm <sup>3</sup> )		
	Units/Tube 只/套管	Tubes/Inner Box 套管/盒	Units/Inner Box 只/盒	Inner Boxes/Outer Box 盒/箱	Units/Outer Box 只/箱	Tube 套管	Inner Box 盒	Outer Box 箱
TO-220/F	50	20	1,000	5	5,000	532×31.4×5.5	555×164×50	575×290×180

**使用说明 / Notices**