

Product Specification

GOODARK Type

MBR30150CT/MBRF30150CT

Construction : Schottky Barrier Rectifier

Application : For General Purpose

(Manufacturer) :

Suzhou Goodark Electronics Co.,Ltd

Prepared on Sep. 17th, 2008

Prepared: R & D Department

Approval: QRA Department

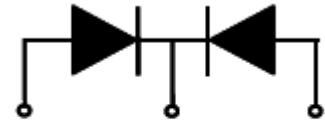

1. Anode 2.Cathode 3. Anode

SCHOTTKY BARRIER RECTIFIER
30 AMPERES
150VOLTS

CONTENTS

1. Package Outline
2. Marking
3. Features& Mechanical Characteristics
4. Maximum Ratings and Electrical Characteristics
5. Rating and characteristic Curves
6. Packing Specification PACKAGING SPECIFICATION
7. Description of Box Label

1. Package Outline (TO220-AB)

UNIT:mm

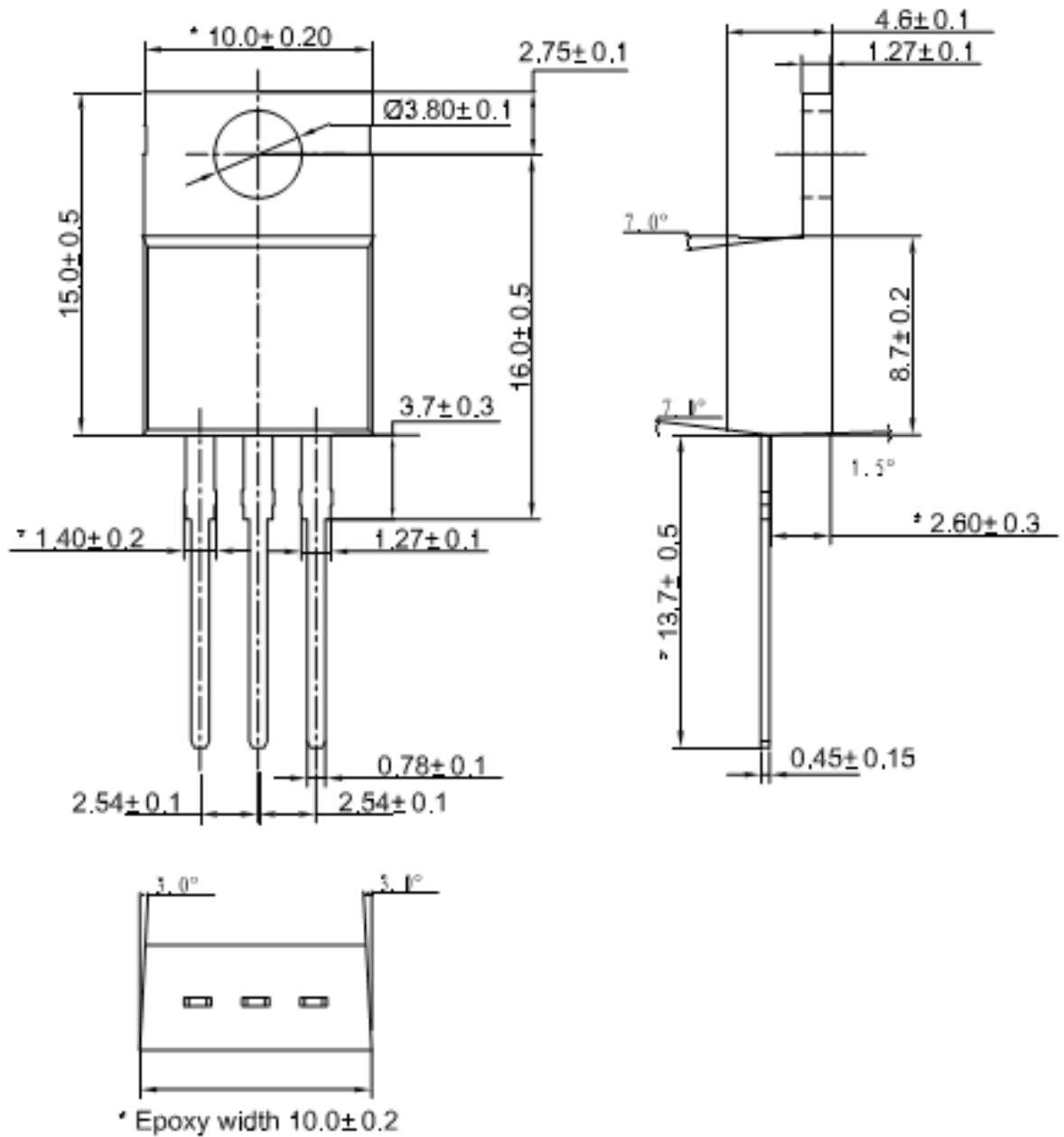

2.MARKING

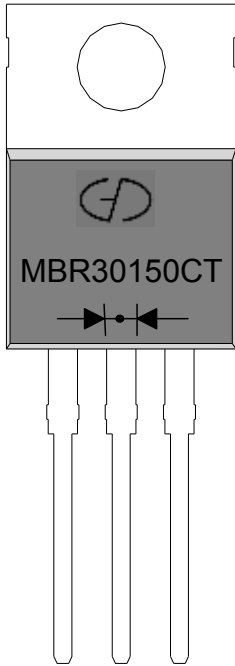

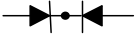
1. Part Name : MBR30150CT(TO220AB)
MBRF30150CT(TO220F-AB)
2. Logo Mark: 
3. Polarity: 



3.Features& Mechanical Characteristics Features

- Plastic package has underwriters Laboratory
Flammability Classification 94V-0
- Dual rectifier construction, positive center tap
- Metal of silicon rectifier, majority carrier conduction
- Low forward voltage, high efficiency
- Guarding for over voltage protection
- For use in low voltage, high frequency inverters,
- Free wheeling, and polarity protection applications

Mechanical Characteristics

- Case: Epoxy, Molded
- Weight: 1.9grams (approximately)
- Finish: All External Surfaces Corrosion Resistant and Terminal Leads are Readily Solderable
- Lead Temperature for Soldering Purposes: 260°C Max.for10 sec
- Shipped 50 units per plastic tube

4.Maximum Ratings and Electrical Characteristics

MAXIMUM RATINGS and ELECTRICAL CHARACTERISTICS(TC=25°C unless otherwise moted)					
PARAMETER	TEST CONDITIONS		SYMBOL	MBR(F)30150CT	UNIT
Maximum repetitive peak reverse voltage			VRRM	150	V
Working peak reverse voltage			VRWM	150	V
Maximum DC blocking voltage			VDC	150	V
Maximum average forward rectified current at Tc=105°C total device per diode			IF(AV)	15 30	A
Peak forward surge current 8.3ms single half sine-wave superimposed on rated load per diode			IFSM	20	A
Peak repetitive reverse current per leg at tp=2.0us , 1KHz			Irrm	1	A
Voltage rate of change (rated VR)			DV/dt	10000	V/us
Operating junction temperature range			TJ	-55 to+150	°C
Isolation voltage (ITO-220AB only) from terminal to heatsink t = 1 sec			VAC	1500	V
Storage temperature range			TSTG	-55 to+150	°C
Maximum instantaneous forward voltage per leg	IF=15A	TC=25°C	VF	0.99	V
	IF=30A	TC=25°C		1.10	
Maximum reverse current per leg at working peak Reverse voltage			IR	200	uA
				10	

Thermal Characteristics Ta=25°C unless otherwise noted

Symbol	Parameter	Max (TO220AB)	Max (TO220AB)	Unit
RθJC	Thermal Resistance, Junction to Case per Leg	2.0	4.0	°C /W
RθJA	Thermal Resistance, Junction to Ambient per Leg	62.5	62.5	°C /W

Note:

1. Screw mounting with 4-40 screw, where washer diameteris≤4.9mm(0.19 ")
2. Pulse test:300us pulse width,1% duty cycle



5. Rating and Characteristic Curves

(TA = 25 °C unless otherwise noted)

FIG.1- FORWARD CURRENT DERATING CURVE

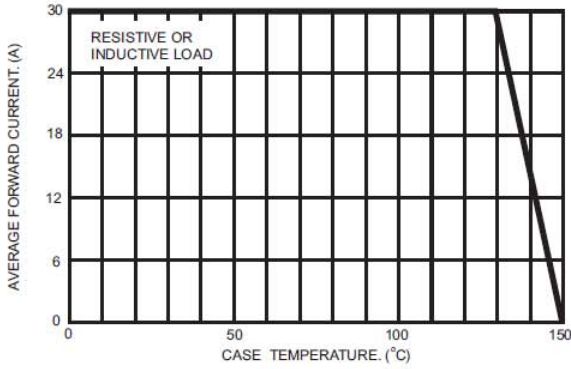

FIG.2- MAXIMUM NON-REPETITIVE FORWARD SURGE CURRENT PER LEG

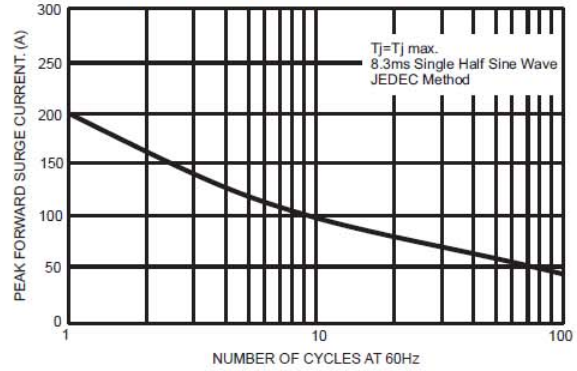

FIG.3- TYPICAL INSTANTANEOUS FORWARD CHARACTERISTICS PER LEG

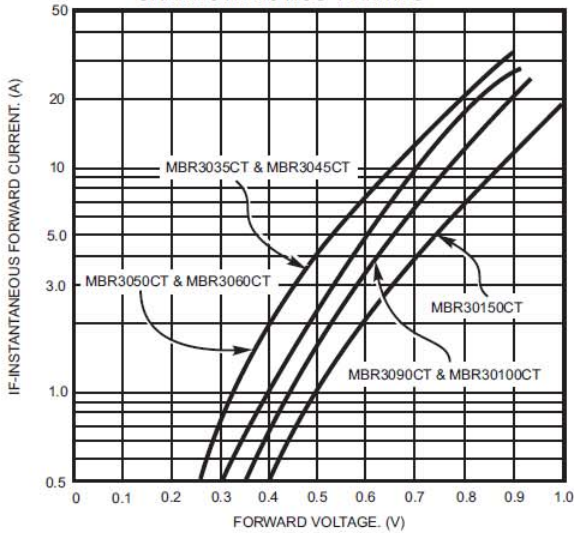

FIG.4- TYPICAL REVERSE CHARACTERISTICS PER LEG

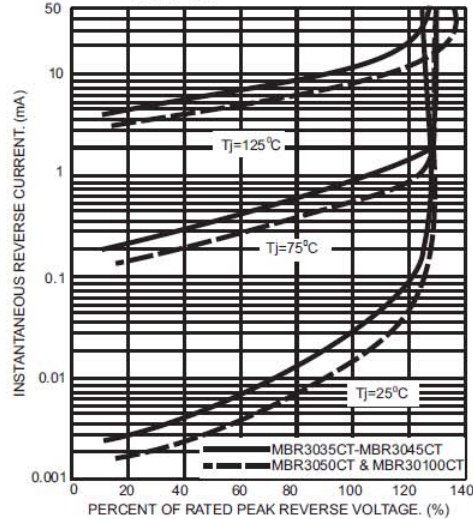

FIG.5- TYPICAL JUNCTION CAPACITANCE PER LEG

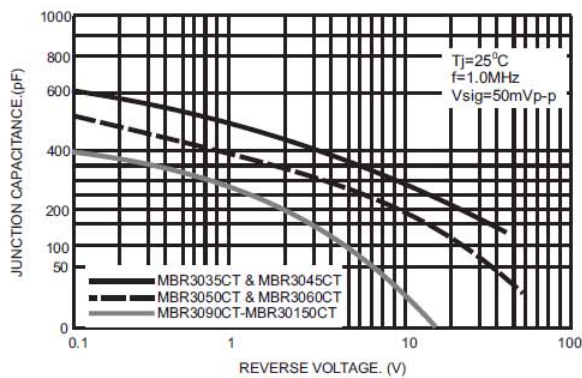
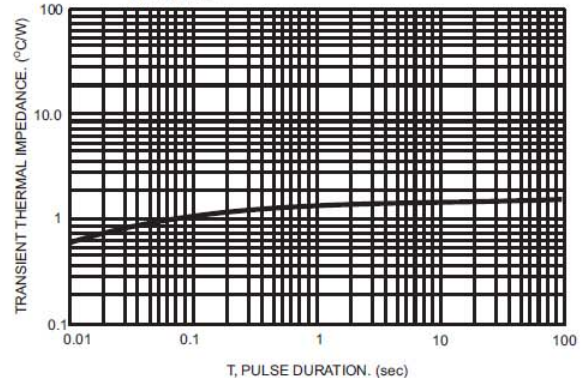







FIG.6- TYPICAL TRANSIENT THERMAL IMPEDANCE PER LEG



6. Packing Specification

	
<p>1) Tube : 50units</p>	<p>2) Inner Box: 20 tube(1000units)</p>
	
<p>3) Outer Box: 10 inner box (10,000units)</p>	

7. DESCRIPTION of BOX LABEL

	<p>TYPE: Q'TY: P/O NO: LOT NO:</p>
<p>1) Inner Box Label</p>	<p>2) Inner Box Label</p>
	<p>TYPE: Q'TY: P/O NO:</p>
<p>3) Outer Box Label</p>	<p>4) Outer Box Label</p>