

MG25J6ES40

HIGH POWER SWITCHING APPLICATIONS.
MOTOR CONTROL APPLICATIONS.

- The Electrodes are Isolated from Case.
- 6 IGBTs are Built Into 1 Package.
- Enhancement-Mode
- Low Saturation Voltage
: $V_{CE(sat)} = 3.5V$ (Max.) ($I_C = 25A$)
- High Speed: $t_f = 0.35\mu s$ (Max.) ($I_C = 25A$)
 $t_{rr} = 0.15\mu s$ (Max.) ($I_F = 25A$)

Unit in mm

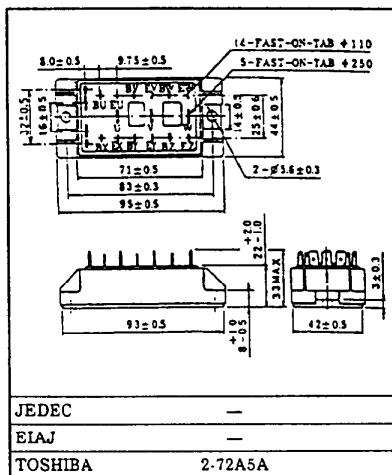

Weight : 225g

EQUIVALENT CIRCUIT

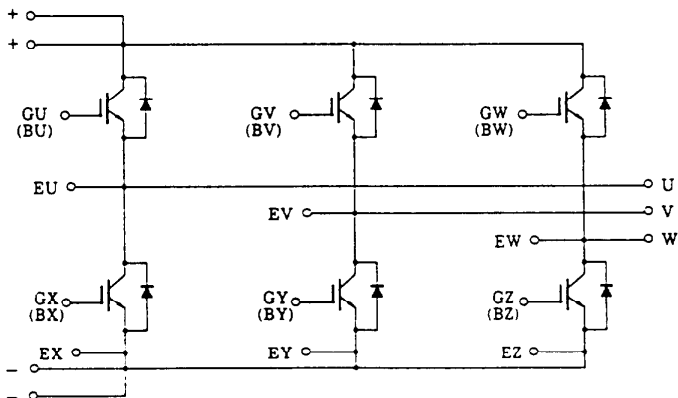

MAXIMUM RATINGS (Ta = 25°C)

CHARACTERISTIC	SYMBOL	RATING	UNIT
Collector-Emitter Voltage	V _{CES}	600	V
Gate-Emitter Voltage	V _{GES}	±20	V
Collector Current	DC	I _C	25
	1ms	I _{CP}	50
Forward Current	DC	I _F	25
	1ms	I _{FM}	50
Collector Power Dissipation (Tc = 25°C)	P _C	100	W
Junction Temperature	T _j	150	°C
Storage Temperature Range	T _{stg}	-40~125	°C
Isolation Voltage	V _{Isol}	2500 (AC, 1 min.)	V
Screw Torque	—	3	N·m

ELECTRICAL CHARACTERISTICS (Ta = 25°C)

CHARACTERISTIC	SYMBOL	TEST CONDITION	MIN.	TYP.	MAX.	UNIT	
Gate Leakage Current	I _{GES}	V _{GE} = ±20V, V _{CE} = 0	—	—	±500	nA	
Collector Cut-off Current	I _{CES}	V _{CE} = 600V, V _{GE} = 0	—	—	1.0	mA	
Collector-Emitter Breakdown Voltage	V _{(BR)CES}	I _C = 10mA, V _{GE} = 0	600	—	—	V	
Gate-Emitter Cut-off Voltage	V _{GE(off)}	I _C = 25mA, V _{CE} = 5V	3.0	—	6.0	V	
Collector-Emitter Saturation Voltage	V _{CE(sat)}	I _C = 25A, V _{GE} = 15V	—	2.7	3.5	V	
Input Capacitance	C _{ies}	V _{CE} = 10V, V _{GE} = 0, f = 1MHz	—	2000	—	pF	
Switching Time	Rise Time	t _r		—	0.3	0.6	μs
	Turn-on Time	t _{on}		—	0.4	0.8	
	Fall Time	t _f		—	0.18	0.35	
	Turn-off Time	t _{off}		—	0.60	1.0	
Forward Voltage	V _F	I _F = 25A, V _{GE} = 0	—	1.7	2.5	V	
Reverse Recovery Time	t _{rr}	I _F = 25A, V _{GE} = -10V di/dt = 50A/μs	—	0.08	0.15	μs	
Thermal Resistance	R _{th(j-c)}	Transistor	—	—	1.25	°C/W	
		Diode	—	—	1.56		

MG25J6ES40

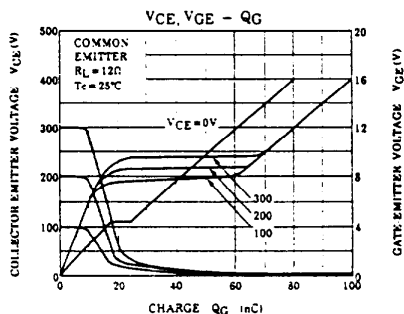
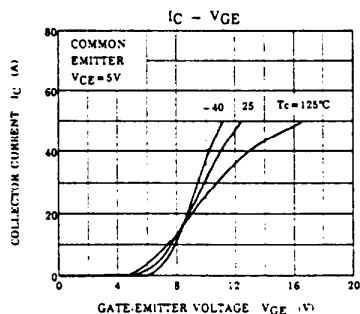
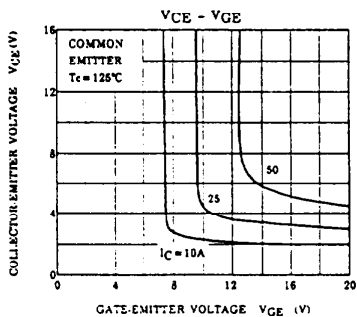
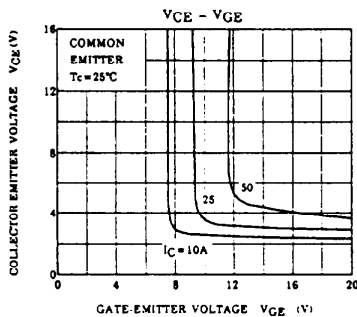
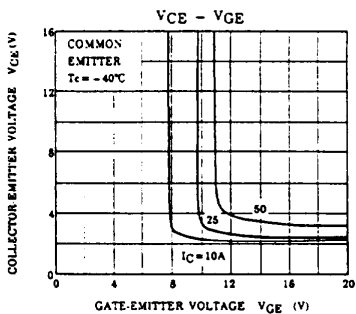
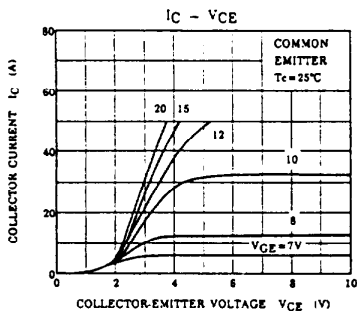

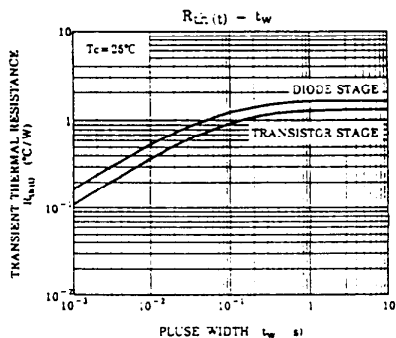
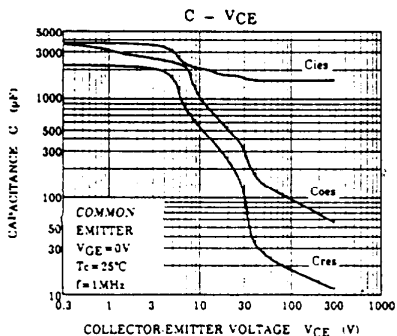
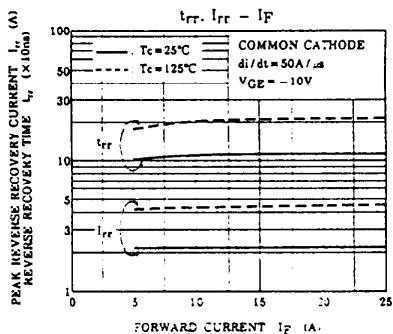
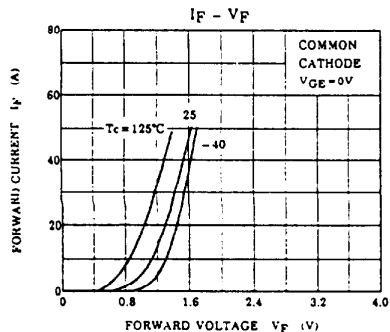
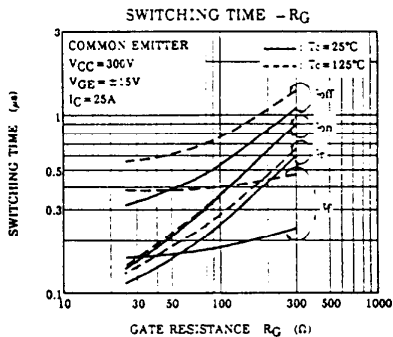
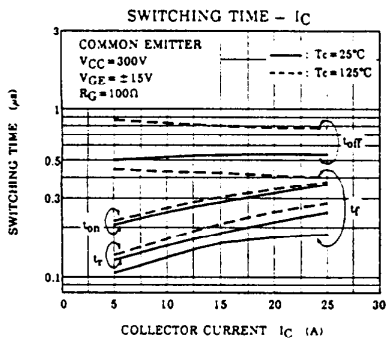

MG25J6ES40

