

# MH205

## High Linearity Cellular-Band MMIC Mixer *Product Information*



### Product Features

- +33 dBm IIP3
- RF 800 – 915 MHz
- IF 70 – 120 MHz
- ISO & EPC compliant
- Low-side LO configuration
- +17 dBm Drive Level
- Low Cost SOIC-8 Package
- No External Bias Required

### Applications

- RFID: UHF
- Readers
  - Industrial
  - Portable
  - Handheld

### Product Description

The MH205 is a passive GaAs MESFET mixer that provides high dynamic range performance in a low cost SOIC-8 package. Its robustness and ease of use make it an ideal candidate for the core of any RFID reader application. It is compliant with EPC and ISO standards. WJ's MH205 uses patented techniques to realize +33 dBm Input IP3 at an LO drive level of +17 dBm when used in a simple application circuit as an upconverting or downconverting low-side LO configuration. This single monolithic integrated circuit does not require any external baluns or bias elements.

Typical applications include frequency up/down conversion, modulation and demodulation for receivers and transmitters used in various current and next generation RFID technologies such as EPC, ISO, ETSI, and ANSI. Their small size makes them ideal for PCMCIA applications.

### Functional Diagram

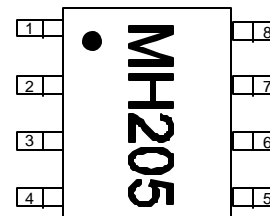

Function	Pin No.
LO	2
IF & RF*	7
GND	1, 3, 4, 5, 6, 8

\* External components (inductors & capacitors) are required to diplex the signal

### Specifications<sup>1</sup>

Parameters	Units	Min	Typ	Max	Comments
RF Frequency Range	MHz	800		915	
LO Frequency Range	MHz	700		845	
IF Frequency Range	MHz	70		120	
SSB Conversion Loss	dB		8.7	9.5	
Noise Figure	dB		9.2		See note 2
Input IP3	dBm	+28	+33		See note 3
Input P1dB	dBm		+18		
LO – RF Isolation	dB	30	37		
LO – IF Isolation	dB	47	51		
RF – IF Isolation	dB		15		
Return Loss: RF Port	dB		12		See note 4
Return Loss: IF Port	dB		14		See note 4
Return Loss: LO Port	dB		8		
LO Drive Level	dBm		+17		

Test conditions unless otherwise noted:

1. Performance is with the use of an application specific circuit (shown on page 4) with a low-side LO at +17 dBm in a downconverting application at 25° C.
2. Assumes LO injection noise is filtered at the thermal noise floor, -174 dBm/Hz, at the RF, IF, and Image frequencies.
3. IIP3 is measured with  $\Delta f = 1$  MHz with  $RF_{in} = 0$  dBm / tone.
4. The return loss is measured after the diplexer which splits the RF and IF signals from the mixer. Details of the diplexing circuit is shown on page 4.

### Absolute Maximum Rating

Parameter	Rating
Operating Case Temperature	-40° to +85 °C
Storage Temperature	-65° to +100 °C
Maximum Input LO Power <sup>6</sup>	+21 dBm

5. Operation of this device above any of these parameters may cause permanent damage.
6. Total sum of the LO and RF port power should not exceed +23 dBm.

### Ordering Information

Part No.	Description
MH205	Cellular-band MMIC Mixer
MH205-PCB	Fully -Assembled Mixer Application Board

Specifications and information are subject to change without notice



## Typical Performance Plots: Low-side Downconversion

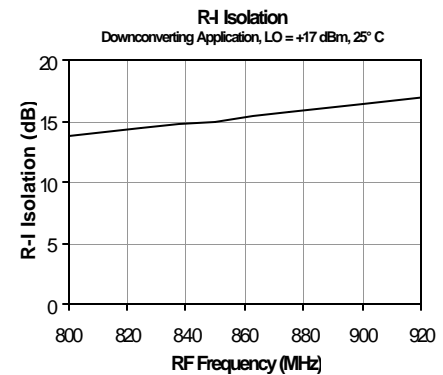
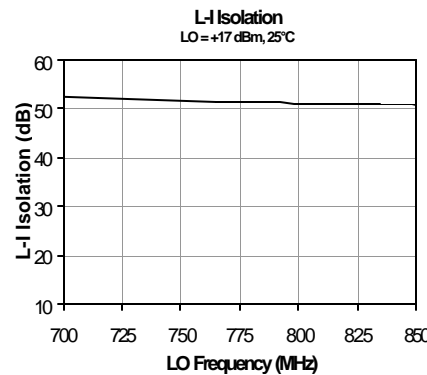
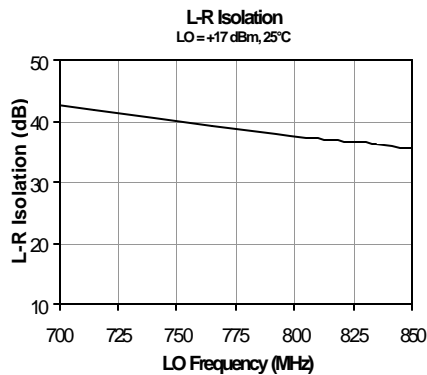
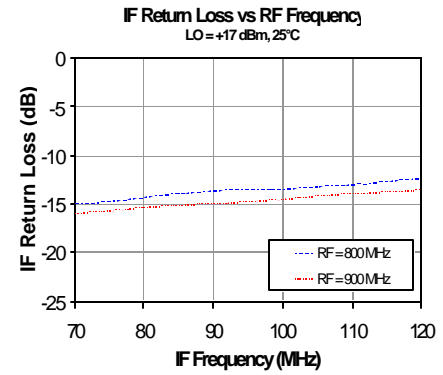
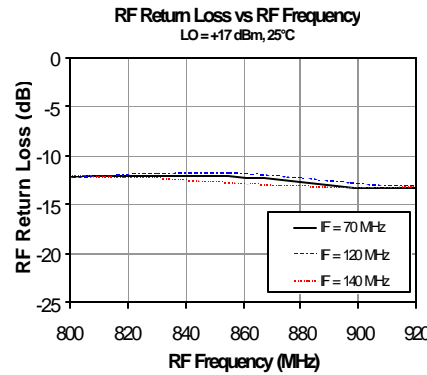
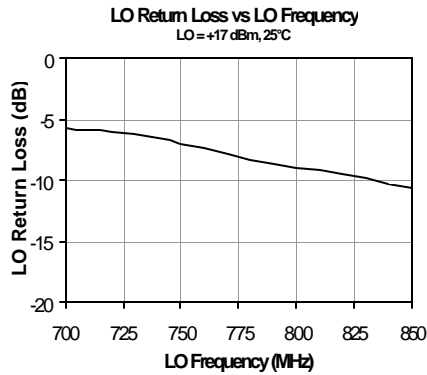
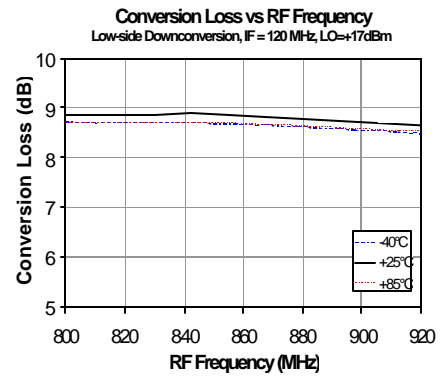
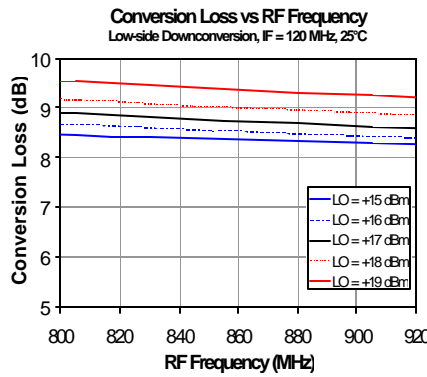
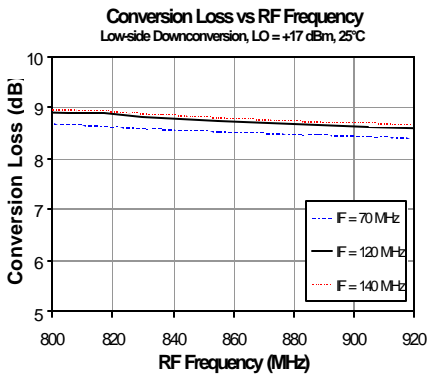
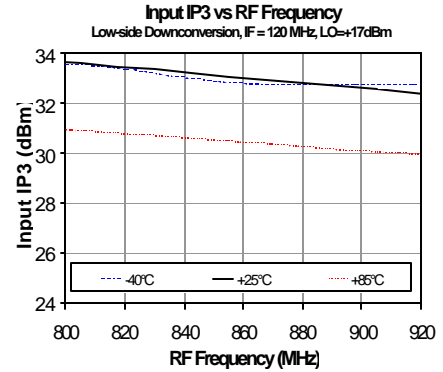
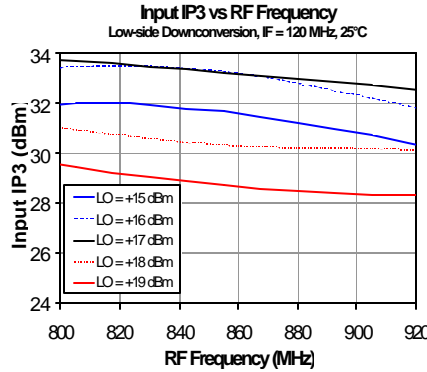
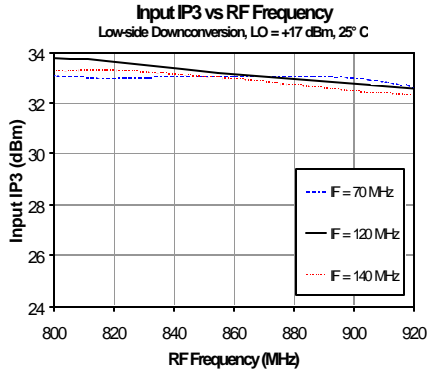



## Typical Performance Plots: Low-side Upconversion

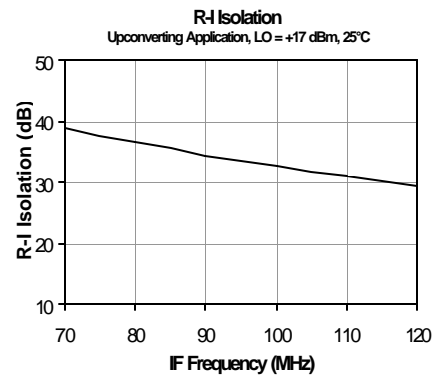
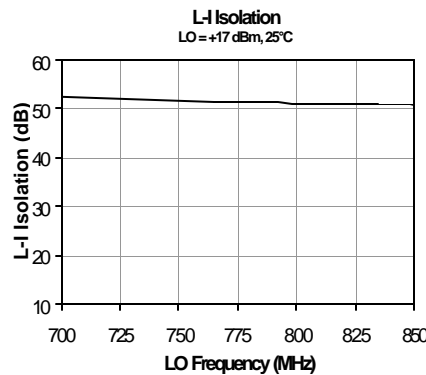
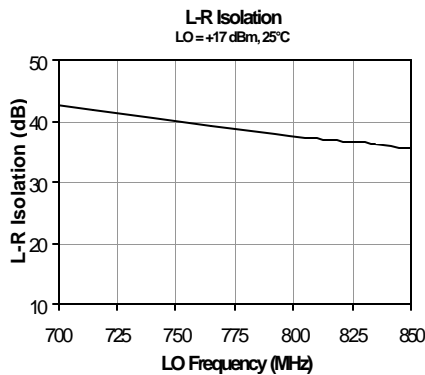
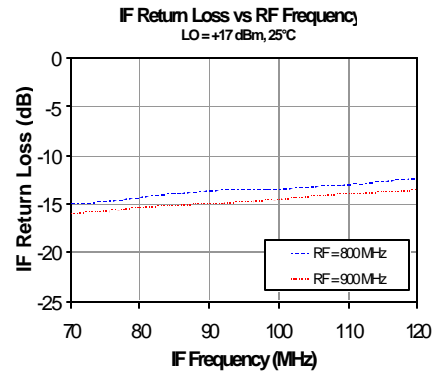
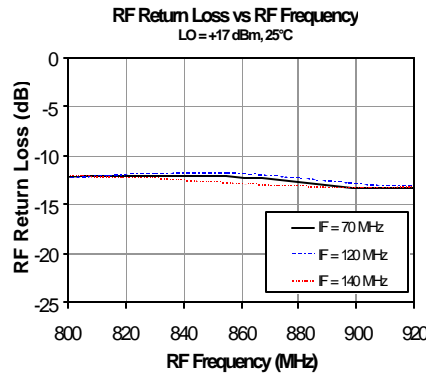
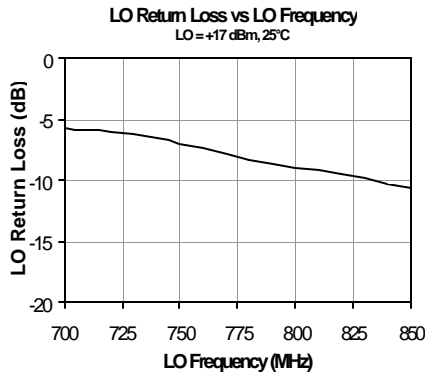
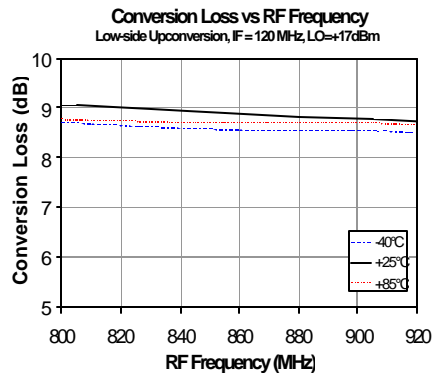
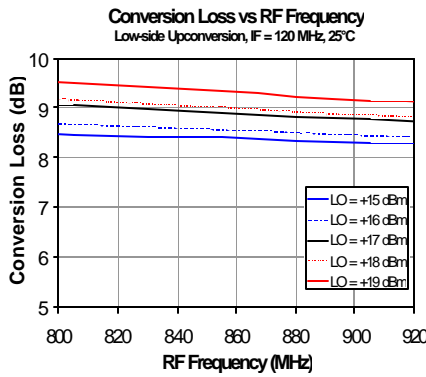
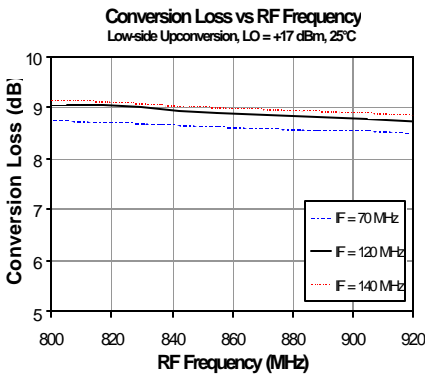
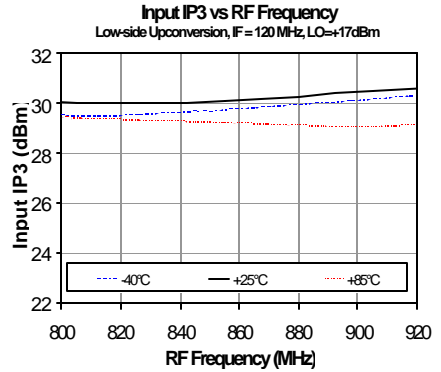
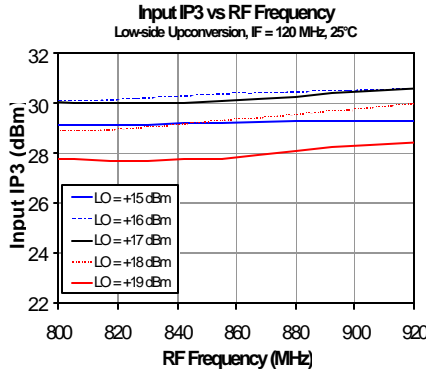
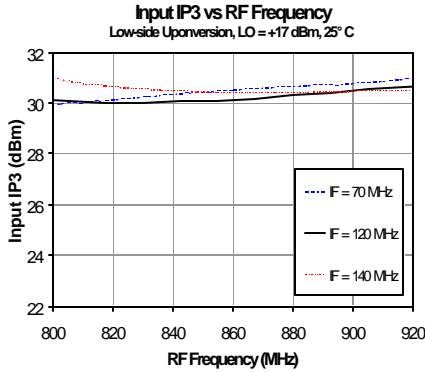

# MH205

High Linearity Cellular-Band MMIC Mixer

Product Information



## Application Circuit (MH205-PCB)

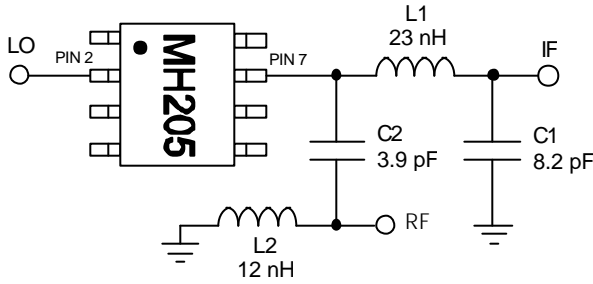

All components are of size 0402.  
All other pins on mixer are grounded.

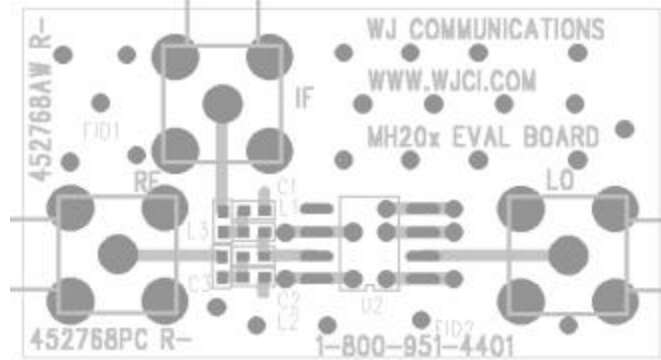

Circuit Board Material: .014" FR-4, 4 layers, .062" total thickness

## Outline Drawing

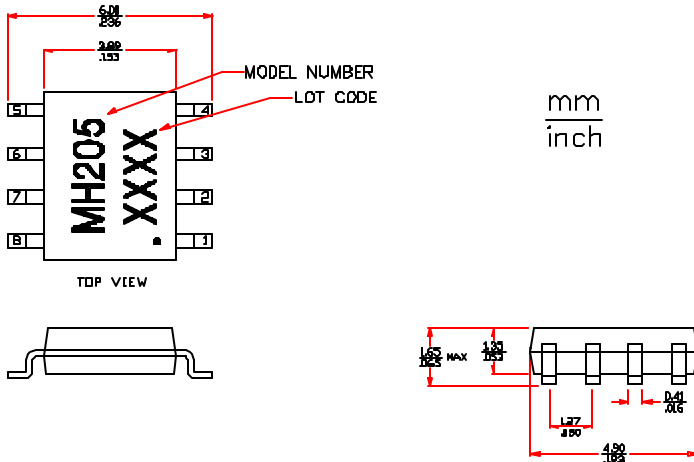

## Product Marking

The component will be marked with an "MH205" designator followed by a four- or five-digit alphanumeric lot code on the top surface of the package. Tape and reel specifications for this part is located on the website in the "Application Notes" section.

## ESD / MSL Information



Caution! ESD sensitive device.

ESD Classification: Class 1B  
Value: Passes /500 V to <1000 V  
Test: Human Body Model (HBM)  
Standard: JEDEC Standard JESD22-A114

ESD Classification: Class III  
Value: Passes /500 V to <1000 V  
Test: Charged Device Model (CDM)  
Standard: JEDEC Standard JESD22-C101

MSL Rating: Level 3 at +235 °C convection reflow  
Standard: JEDEC Standard J-STD-020B

## Mounting Configuration / Land Pattern

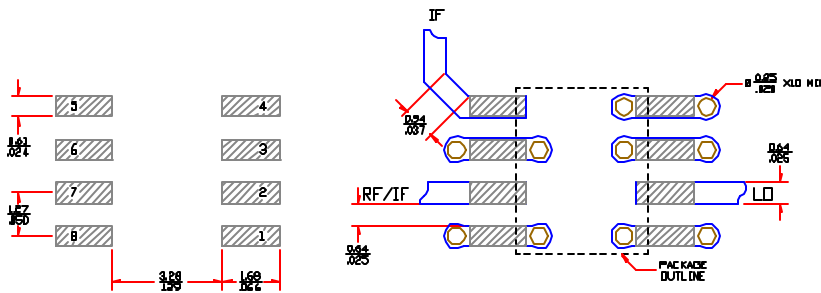

- Notes:
1. Ground vias are critical for thermal and RF grounding considerations.
  2. A minimum of 30 ground vias are required for 1.4 mil and 20 mil FR4 board.
  3. If your PCB design rules allow, ground vias should be placed under the land pattern for better RF and thermal performance. Otherwise ground vias should be placed as close to land pattern as possible.
  4. Trace width depends on PCB board.

## Functional Pin Layout

Pin	Function
1	Ground
2	LO Port
3	Ground
4	Ground
5	Ground
6	Ground
7	RF / IF Port*
8	Ground

\* External components (inductors & capacitors) are required to diplex the signal

Specifications and information are subject to change without notice