

## SOT-23 Plastic-Encapsulate Transistors

### TRANSISTOR( PNP )

#### Features

- Complementary to MMBT5551
- Ideal for Medium Power Amplification and Switching

#### Marking:

- 2L

#### Limiting Values (Absolute Maximum Rating)

Symbol	Parameter	Value	Unit
$V_{CBO}$	Collector-Base Voltage	-160	V
$V_{CEO}$	Collector-Emmitter Voltage	-150	V
$V_{EBO}$	Emitter-Base Voltage	-5	V
$I_C$	Collector Current	-600	mA
$P_C$	Collector Power Dissipation	300	mW
$R_{\theta JA}$	Thermal Resistance From Junction To Ambient	416	$^{\circ}C/W$
$T_j$	Junction Temperature	150	$^{\circ}C$
$T_{stg}$	Storage Temperature	-55~+150	$^{\circ}C$

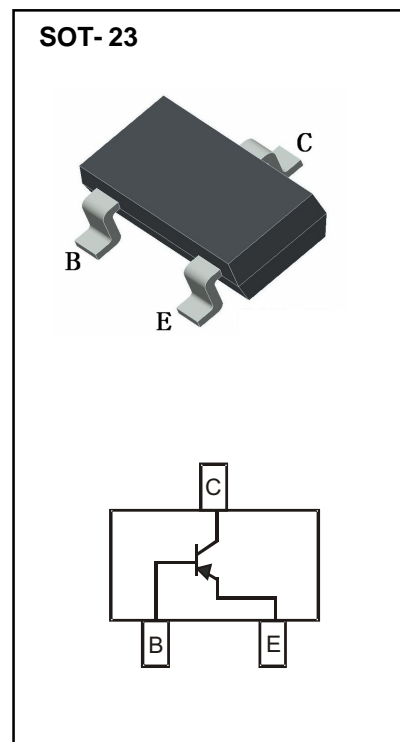

Downloaded from alldatasheet.com

#### Electrical Characteristics (Ta=25 $^{\circ}C$ Unless otherwise specified)

Parameter	Symbol	Test conditions	Min	Typ	Max	Unit
Collector-base breakdown voltage	$V_{(BR)CBO}$	$I_C=-100\mu A, I_E=0$	-160			V
Collector-emitter breakdown voltage	$V_{(BR)CEO}^*$	$I_C=-1mA, I_B=0$	-150			V
Emitter-base breakdown voltage	$V_{(BR)EBO}$	$I_E=-10\mu A, I_C=0$	-5			V
Collector cut-off current	$I_{CBO}$	$V_{CB}=-120V, I_E=0$			-0.1	$\mu A$
Emitter cut-off current	$I_{EBO}$	$V_{EB}=-4V, I_C=0$			-0.1	$\mu A$
DC current gain	$h_{FE(1)}^*$	$V_{CE}=-5V, I_C=-1mA$	80			
	$h_{FE(2)}^*$	$V_{CE}=-5V, I_C=-10mA$	100		300	
	$h_{FE(3)}^*$	$V_{CE}=-5V, I_C=-50mA$	50			
Collector-emitter saturation voltage	$V_{CE(sat)1}^*$	$I_C=-10mA, I_B=-1mA$			-0.2	V
	$V_{CE(sat)2}^*$	$I_C=-50mA, I_B=-5mA$			-0.5	V
Base-emitter saturation voltage	$V_{BE(sat)1}^*$	$I_C=-10mA, I_B=-1mA$			-1	V
	$V_{BE(sat)2}^*$	$I_C=-50mA, I_B=-5mA$			-1	V
Transition frequency	$f_T$	$V_{CE}=-5V, I_C=-10mA, f=30MHz$	100			MHz

\*Pulse test: pulse width  $\leq 300\mu s$ , duty cycle  $\leq 2.0\%$ .

#### CLASSIFICATION OF $h_{FE}$

RANK	L	H
RANGE	100-200	200-300

# Typical Characteristics

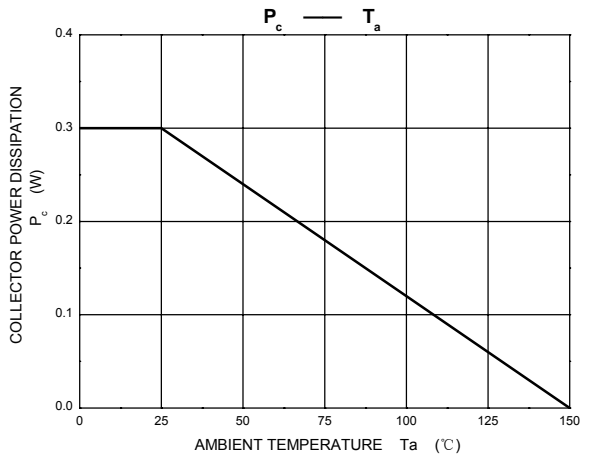
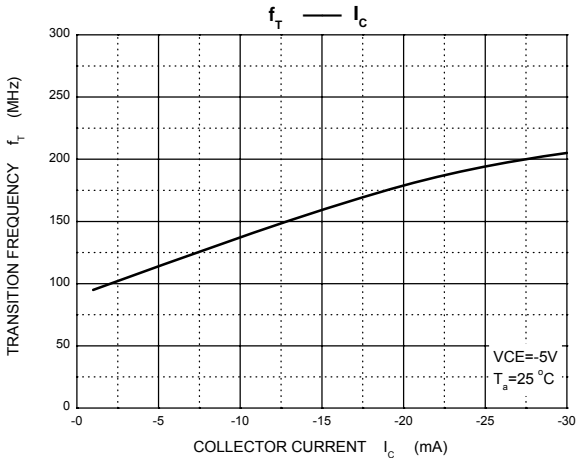
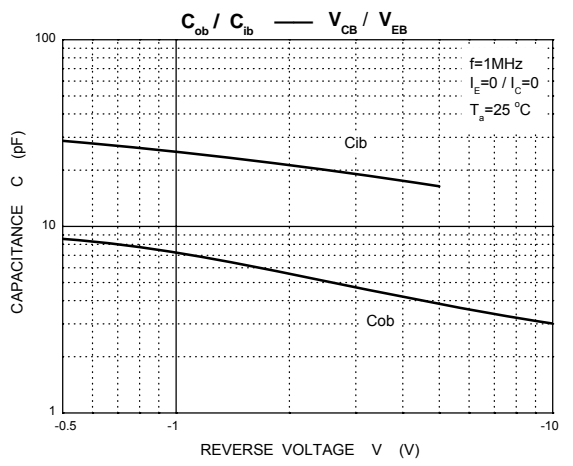
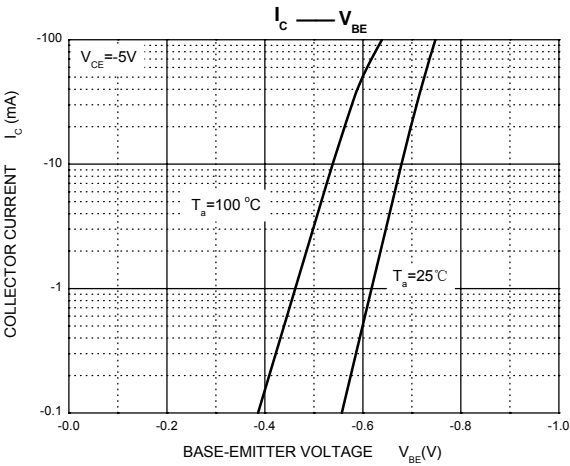
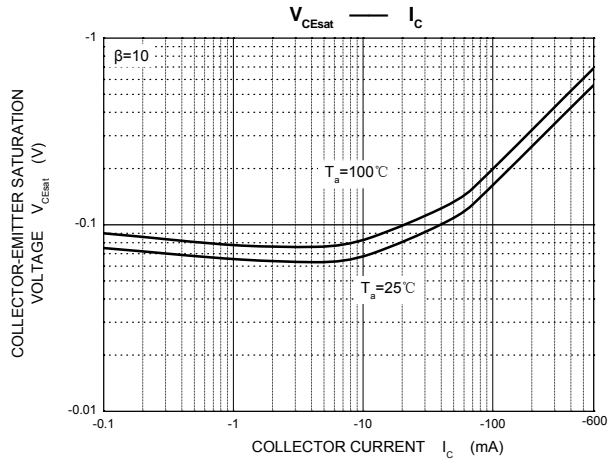
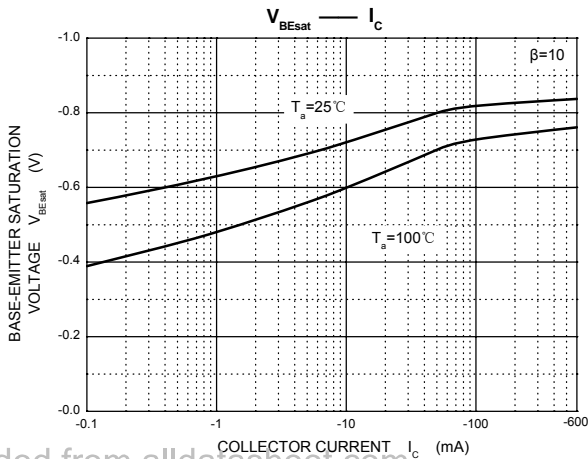
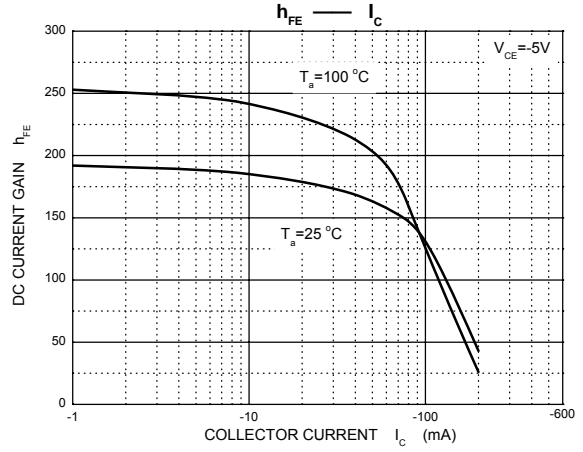
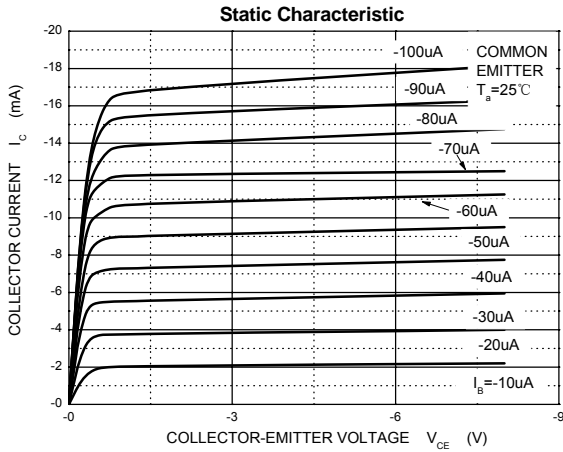

## SOT-23 Package Outline Dimensions

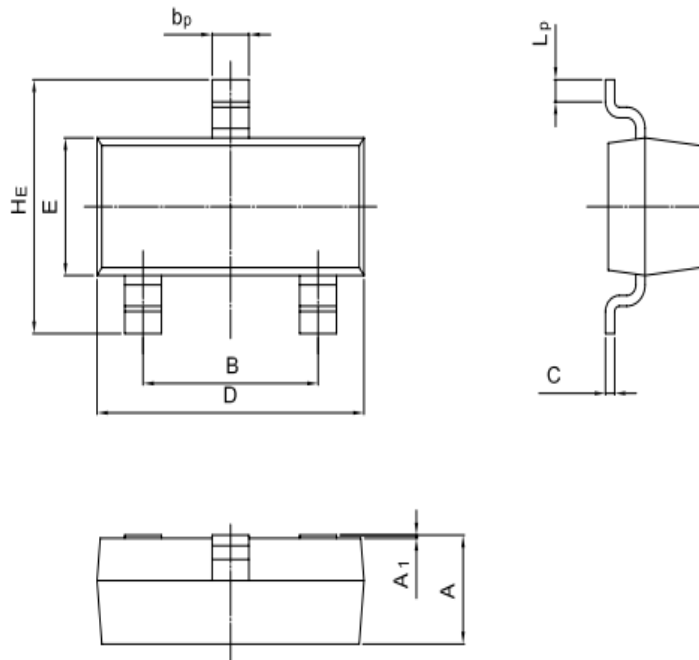

UNIT	A	B	bp	C	D	E	HE	A1	Lp
mm	1.40 0.95	2.04 1.78	0.50 0.35	0.19 0.08	3.10 2.70	1.65 1.20	3.00 2.20	0.100 0.013	0.50 0.20

Downloaded from alldatasheet.com

## SOT-23 Suggested Pad Layout

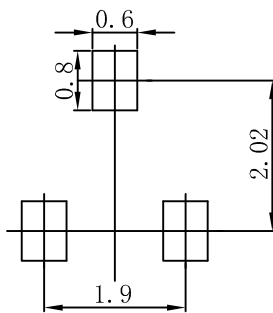

**Note:**

1. Controlling dimension: in millimeters.
2. General tolerance:  $\pm 0.05\text{mm}$ .
3. The pad layout is for reference purposes only.

**NOTICE**

JSJD reserve the right to make modifications, enhancements, improvements, corrections or other changes without further notice to any product herein. JSJD does not assume any liability arising out of the application or use of any product described herein.

# Reel Taping Specifications For Surface Mount Devices-SOT-23

## SOT-23 Embossed Carrier Tape

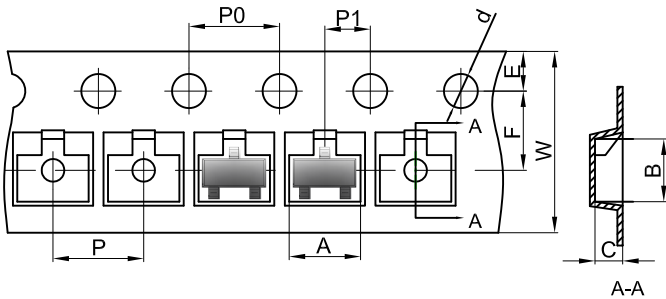

### Packaging Description:

SOT-23 parts are shipped in tape. The carrier tape is made from a dissipative (carbon filled) polycarbonate resin. The cover tape is a multilayer film (Heat Activated Adhesive in nature) primarily composed of polyester film, adhesive layer, sealant, and anti-static sprayed agent. These reeled parts in standard option are shipped with 3,000 units per 7" or 17.8cm diameter reel. The reels are clear in color and is made of polystyrene plastic (anti-static coated).

Dimensions are in millimeter										
Pkg type	A	B	C	d	E	F	P0	P	P1	W
SOT-23	3.15	2.77	1.22	Ø1.50	1.75	3.50	4.00	4.00	2.00	8.00

## SOT-23 Tape Leader and Trailer

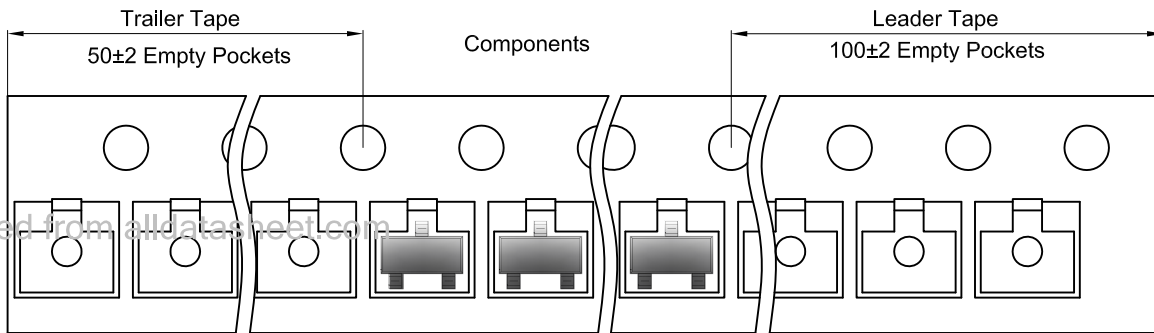

## SOT-23 Reel

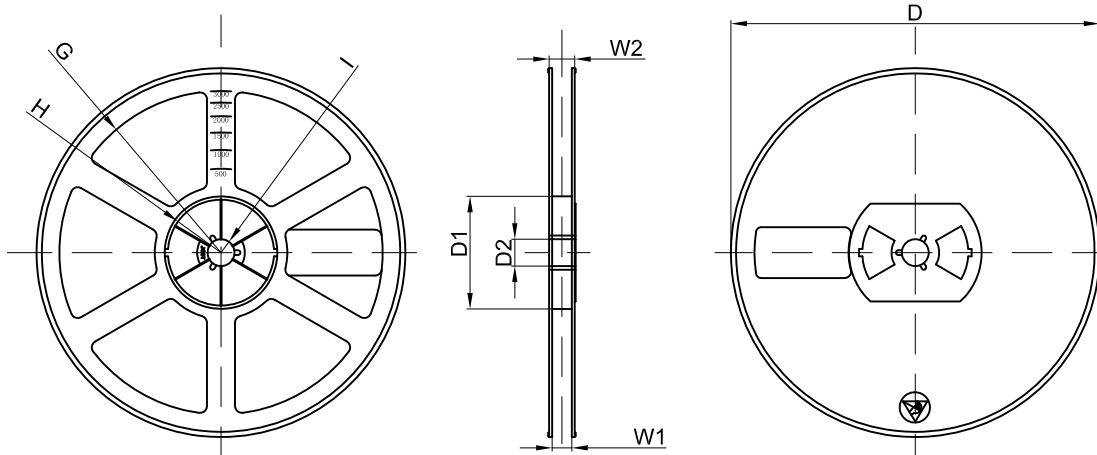

Dimensions are in millimeter								
Reel Option	D	D1	D2	G	H	I	W1	W2
7"Dia	Ø178.00	54.40	13.00	R78.00	R25.60	R6.50	9.50	12.30

REEL	Reel Size	Box	Box Size(mm)	Carton	Carton Size(mm)	G.W.(kg)
3000 pcs	7 inch	45,000 pcs	203×203×195	180,000 pcs	438×438×230	