

The RF MOSFET Line
RF Power
Field Effect Transistors
N-Channel Enhancement Mode MOSFETs

Designed primarily for wideband large-signal output and driver from 30–500 MHz.

- Low C_{rss} — 4.5 pF @ $V_{DS} = 28$ V
- MRF166C — Typical Performance at 400 MHz, 28 Vdc
Output Power = 20 W
Gain = 17 dB
Efficiency = 55%
- Replacement for Industry Standards such as MRF136, DV2820, BLF244, SD1902, and ST1001
- 100% Tested for Load Mismatch at all Phase Angles with 30:1 VSWR
- Facilitates Manual Gain Control, ALC and Modulation Techniques
- Excellent Thermal Stability, Ideally Suited for Class A Operation
- Circuit board photomaster available upon request by contacting RF Tactical Marketing in Phoenix, AZ.

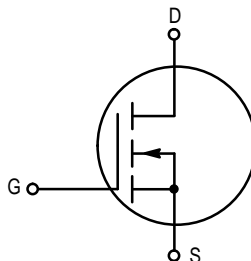

MRF166C

20 W, 500 MHz
MOSFET
BROADBAND
RF POWER FETs

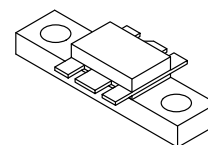

CASE 319-07, STYLE 3

MAXIMUM RATINGS

Rating	Symbol	Value	Unit
Drain-Gate Voltage	V_{DSS}	65	Vdc
Drain-Gate Voltage ($R_{GS} = 1.0$ M Ω)	V_{DGR}	65	Vdc
Gate-Source Voltage	V_{GS}	± 40	Adc
Drain Current — Continuous	I_D	4.0	Adc
Total Device Dissipation @ $T_C = 25^\circ\text{C}$ Derate Above 25°C	P_D	70 0.4	Watts W/ $^\circ\text{C}$
Storage Temperature Range	T_{stg}	-65 to 150	$^\circ\text{C}$
Operating Junction Temperature	T_J	200	$^\circ\text{C}$

THERMAL CHARACTERISTICS

Characteristic	Symbol	Max	Unit
Thermal Resistance, Junction to Case	$R_{\theta JC}$	2.5	$^\circ\text{C}/\text{W}$

NOTE — **CAUTION** — MOS devices are susceptible to damage from electrostatic charge. Reasonable precautions in handling and packaging MOS devices should be observed.

ELECTRICAL CHARACTERISTICS ($T_C = 25^\circ\text{C}$ unless otherwise noted)

Characteristic	Symbol	Min	Typ	Max	Unit
OFF CHARACTERISTICS					
Drain–Source Breakdown Voltage ($V_{GS} = 0\text{ V}$, $I_D = 5.0\text{ mA}$)	$V_{(BR)DSS}$	65	—	—	V
Zero Gate Voltage Drain Current ($V_{DS} = 28\text{ V}$, $V_{GS} = 0\text{ V}$)	I_{DSS}	—	—	1.0	mA
Gate–Source Leakage Current ($V_{GS} = 40\text{ V}$, $V_{DS} = 0\text{ V}$)	I_{GSS}	—	—	1.0	μA
ON CHARACTERISTICS					
Gate Threshold Voltage ($V_{DS} = 10\text{ V}$, $I_D = 25\text{ mA}$)	$V_{GS(th)}$	1.0	3.0	6.0	V
Forward Transconductance ($V_{DS} = 10\text{ V}$, $I_D = 1.5\text{ A}$)	g_{fs}	600	800	—	mhos
DYNAMIC CHARACTERISTICS					
Input Capacitance ($V_{DS} = 28\text{ V}$, $V_{GS} = 0\text{ V}$, $f = 1.0\text{ MHz}$)	C_{iss}	—	30	—	pF
Output Capacitance ($V_{DS} = 28\text{ V}$, $V_{GS} = 0\text{ V}$, $f = 1.0\text{ MHz}$)	C_{oss}	—	35	—	pF
Reverse Transfer Capacitance ($V_{DS} = 28\text{ V}$, $V_{GS} = 0\text{ V}$, $f = 1.0\text{ MHz}$)	C_{rss}	—	4.5	—	pF
FUNCTIONAL CHARACTERISTICS					
Noise Figure ($V_{DD} = 28\text{ V}$, $f = 30\text{ MHz}$, $I_{DQ} = 50\text{ mA}$)	NF	—	2.5	—	dB
Common Source Power Gain ($V_{DD} = 28\text{ V}$, $P_{out} = 20\text{ W}$, $f = 400\text{ MHz}$, $I_{DQ} = 100\text{ mA}$)	G_{ps}	14	17	—	dB
Drain Efficiency ($V_{DD} = 28\text{ V}$, $P_{out} = 20\text{ W}$, $f = 400\text{ MHz}$, $I_{DQ} = 100\text{ mA}$)	η	50	55	—	%
Electrical Ruggedness ($V_{DD} = 28\text{ V}$, $P_{out} = 20\text{ W}$, $f = 400\text{ MHz}$, $I_{DQ} = 100\text{ mA}$, Load VSWR 30:1 at All Phase Angles)	ψ	No Degradation in Output Power			

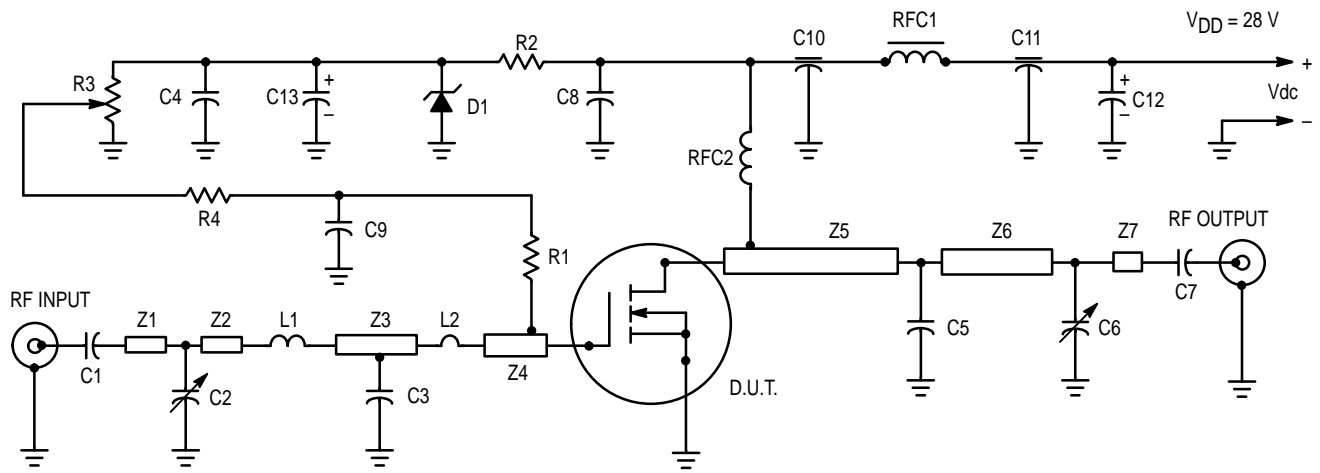

- C1, C7 — 270 pF Chip Capacitor
- C2, C6 — Johanson Trimmer Capacitor, 2–20 pF
- C3 — 21 pF Mini Unelco
- C4, C8, C9 — 0.01 μ F
- C5 — 18 pF Mini Unelco
- C10, C11 — 680 pF Feed Through
- C12, C13 — 50 μ F, 50 V
- D1 — 1N5925A Motorola Zener

Board Material — Teflon fiberglass
 2 oz. Copper clad both sides, $\epsilon_r = 2.55$
 0.060" Dielectric Thickness

- L1 — #18 AWG, 2 Turns, 0.25" ID 0.15" Wide
- L2 — #18 AWG Hairpin 0.7" long, bend into hairpin
- RFC1 — Ferroxcube VK200–19/4B
- RFC2 — 18 Turns #18 AWG Enameled, 0.3" ID
- R1 — 220 Ω 1/2 Watt
- R2 — 1.8 k Ω 1/4 Watt
- R3 — 10 k Ω , 10 Turns Bourns
- R4 — 10 k 1/4 Watt
- Z1 — Microstrip Line 0.150" wide, 0.420" long
- Z2 — Microstrip Line 0.150" wide, 0.350" long
- Z3 — Microstrip Line 0.150" wide, 0.350" long
- Z4 — Microstrip Line 0.150" wide, 0.450" long
- Z5 — Microstrip Line 0.150" wide, 1.1" long
- Z6 — Microstrip Line 0.150" wide, 0.650" long
- Z7 — Microstrip Line 0.150" wide, 0.200" long

Figure 1. MRF166C 400 MHz Test Circuit

TYPICAL CHARACTERISTICS

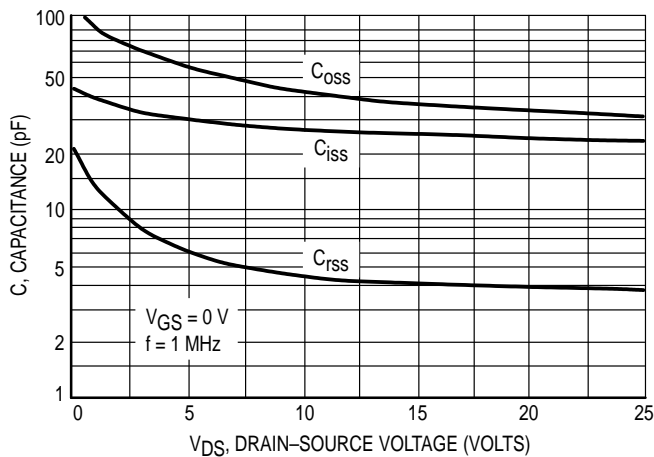

Figure 2. Capacitance versus Drain-Source Voltage

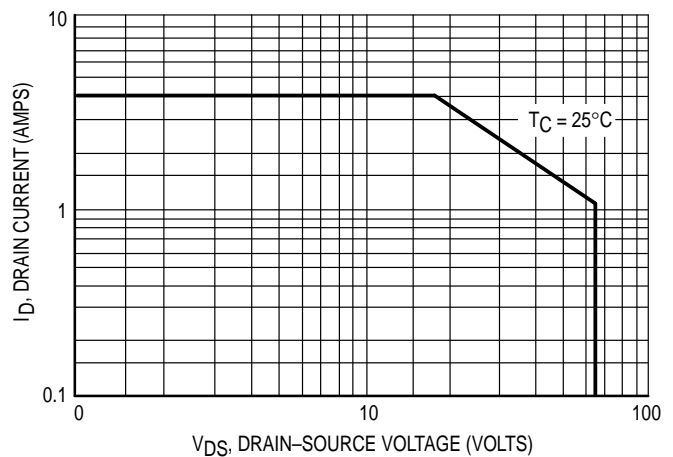

Figure 3. DC Safe Operating Area

TYPICAL CHARACTERISTICS

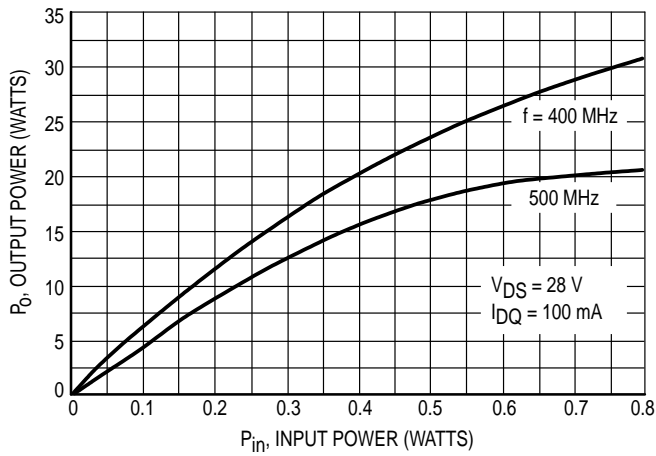

Figure 4. Output Power versus Input Power

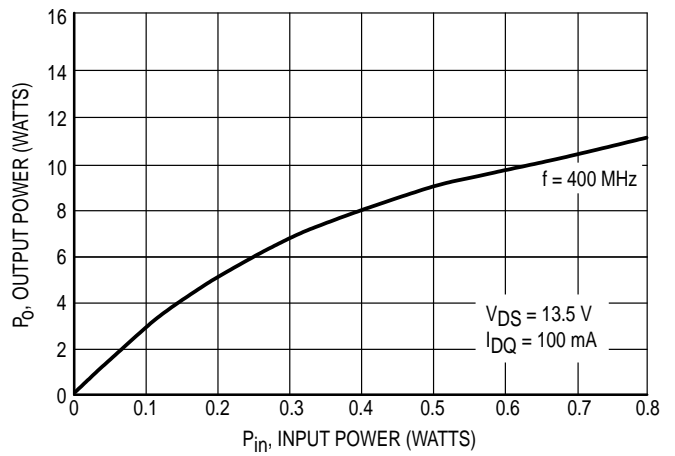

Figure 5. Output Power versus Input Power

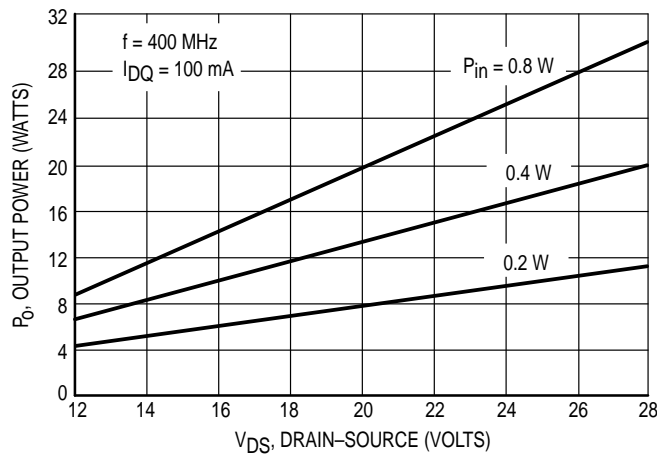

Figure 6. Output Power versus Voltage

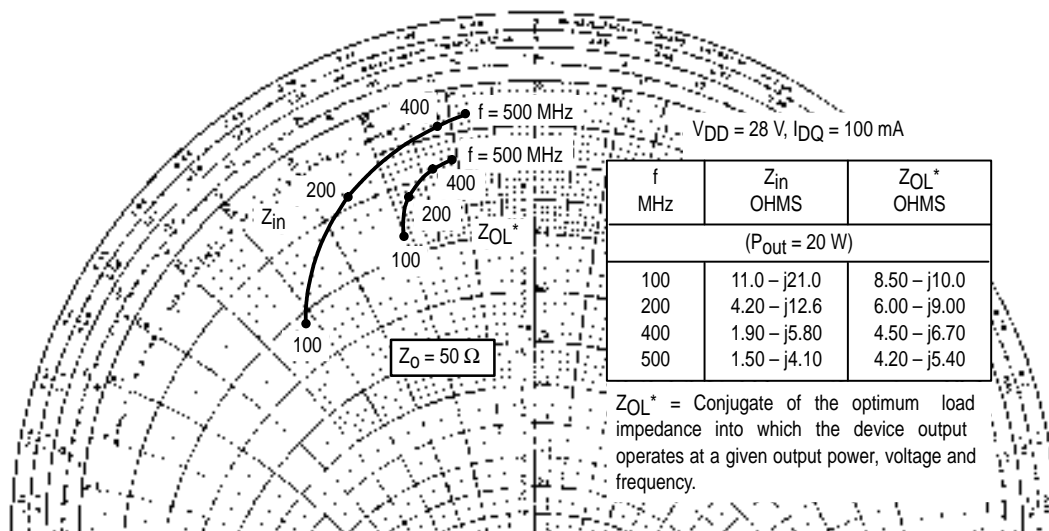
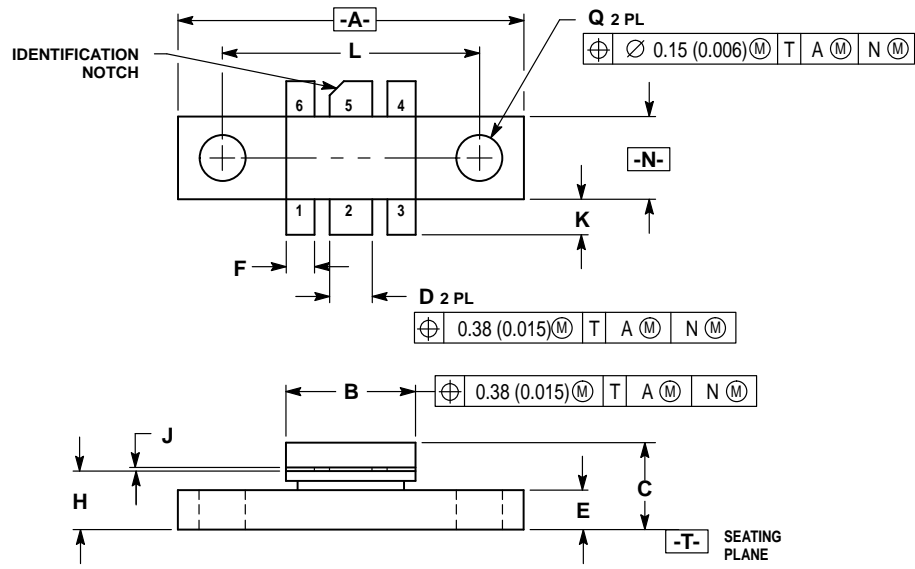

Figure 7. Series Equivalent Input and Output Impedance

PACKAGE DIMENSIONS



NOTES:
 1. DIMENSIONING AND TOLERANCING PER ANSI Y14.5M, 1982.
 2. CONTROLLING DIMENSION: INCH.

DIM	INCHES		MILLIMETER	
	MIN	MAX	MIN	MAX
A	0.965	0.985	24.52	25.01
B	0.355	0.375	9.02	9.52
C	0.230	0.260	5.85	6.60
D	0.115	0.125	2.93	3.17
E	0.102	0.114	2.59	2.90
F	0.075	0.085	1.91	2.15
H	0.160	0.170	4.07	4.31
J	0.004	0.006	0.11	0.15
K	0.090	0.110	2.29	2.79
L	0.725 BSC		18.42 BSC	
N	0.225	0.241	5.72	6.12
Q	0.125	0.135	3.18	3.42

STYLE 3:
 PIN 1. SOURCE (COMMON)
 2. GATE (INPUT)
 3. SOURCE (COMMON)
 4. SOURCE (COMMON)
 5. DRAIN (OUTPUT)
 6. SOURCE (COMMON)

CASE 319-07
 ISSUE M

Motorola reserves the right to make changes without further notice to any products herein. Motorola makes no warranty, representation or guarantee regarding the suitability of its products for any particular purpose, nor does Motorola assume any liability arising out of the application or use of any product or circuit, and specifically disclaims any and all liability, including without limitation consequential or incidental damages. "Typical" parameters can and do vary in different applications. All operating parameters, including "Typicals" must be validated for each customer application by customer's technical experts. Motorola does not convey any license under its patent rights nor the rights of others. Motorola products are not designed, intended, or authorized for use as components in systems intended for surgical implant into the body, or other applications intended to support or sustain life, or for any other application in which the failure of the Motorola product could create a situation where personal injury or death may occur. Should Buyer purchase or use Motorola products for any such unintended or unauthorized application, Buyer shall indemnify and hold Motorola and its officers, employees, subsidiaries, affiliates, and distributors harmless against all claims, costs, damages, and expenses, and reasonable attorney fees arising out of, directly or indirectly, any claim of personal injury or death associated with such unintended or unauthorized use, even if such claim alleges that Motorola was negligent regarding the design or manufacture of the part. Motorola and  are registered trademarks of Motorola, Inc. Motorola, Inc. is an Equal Opportunity/Affirmative Action Employer.

How to reach us:

USA / EUROPE: Motorola Literature Distribution;
P.O. Box 20912; Phoenix, Arizona 85036. 1-800-441-2447

JAPAN: Nippon Motorola Ltd.; Tatsumi-SPD-JLDC, Toshikatsu Otsuki,
6F Seibu-Butsuryu-Center, 3-14-2 Tatsumi Koto-Ku, Tokyo 135, Japan. 03-3521-8315

MFAX: RMFAX0@email.sps.mot.com - TOUCHTONE (602) 244-6609
INTERNET: <http://Design-NET.com>

HONG KONG: Motorola Semiconductors H.K. Ltd.; 8B Tai Ping Industrial Park,
51 Ting Kok Road, Tai Po, N.T., Hong Kong. 852-26629298



MRF166C/D

