



Micro Commercial Components
 21201 Itasca Street Chatsworth
 CA 91311
 Phone: (818) 701-4933
 Fax: (818) 701-4939

MURX0510 THRU MURX0560

Features

- For Surface Mount Application
- Low Leakage
- Low Forward Voltage Drop
- Extremely Low Thermal Resistance
- Super Fast Recovery Time For High Efficiency

Maximum Ratings

- Operating Temperature: -40°C to +150°C
- Storage Temperature: -40°C to +150°C
- Maximum Thermal Resistance: 200°C/W Junction to Ambient

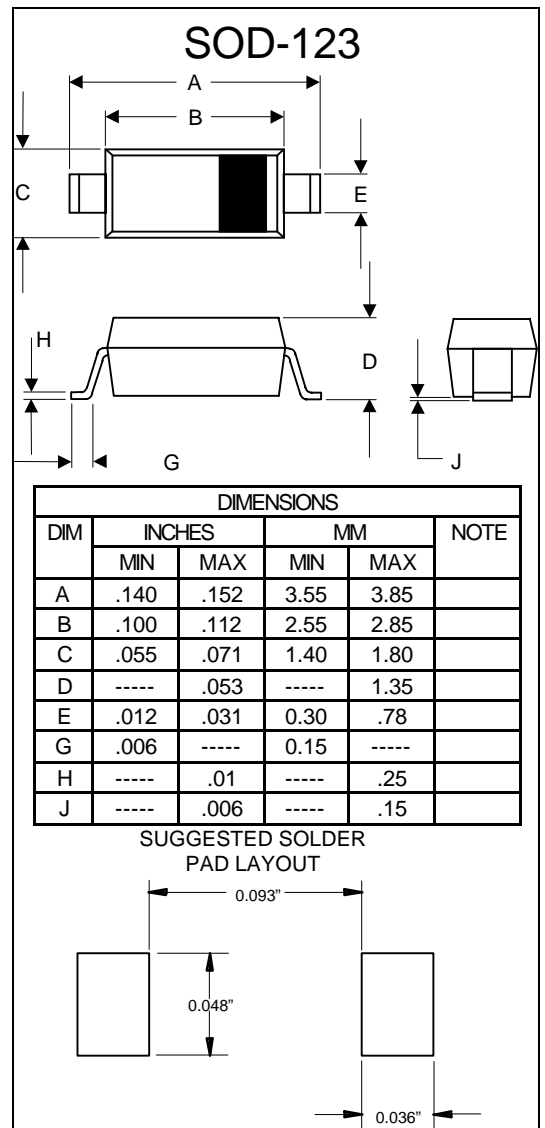
MCC Part Number	Device Marking	Maximum Recurrent Peak Reverse Voltage	Maximum RMS Voltage	Maximum DC Blocking Voltage
MURX0510	U1	100V	70V	100V
MURX0520	U2	200V	140V	200V
MURX0530	U3	300V	210V	300V
MURX0540	U4	400V	280V	400V
MURX0550	U5	500V	350V	500V
MURX0560	U6	600V	420V	600V

Electrical Characteristics @ 25°C Unless Otherwise Specified

Average Forward Current	$I_{F(AV)}$	0.5 A	$T_L = 115^\circ\text{C}$
Peak Forward Surge Current	I_{FSM}	8.0A	8.3ms, half sine
Maximum Instantaneous Forward Voltage	V_F	1.35V	$I_{FM} = 0.5\text{A}; T_A = 25^\circ\text{C}$
Maximum DC Reverse Current At Rated DC Blocking Voltage	I_R	5.0μA	$T_A = 25^\circ\text{C}$
Maximum Reverse Recovery Time	T_{rr}	75ns	$I_F = 0.5\text{A}, I_R = 1.0\text{A}, I_{rr} = 0.25\text{A}$
Typical Junction Capacitance	C_J	10pF	Measured at 1.0MHz, $V_R = 4.0\text{V}$

*Pulse Test: Pulse Width 300μsec, Duty Cycle 2%

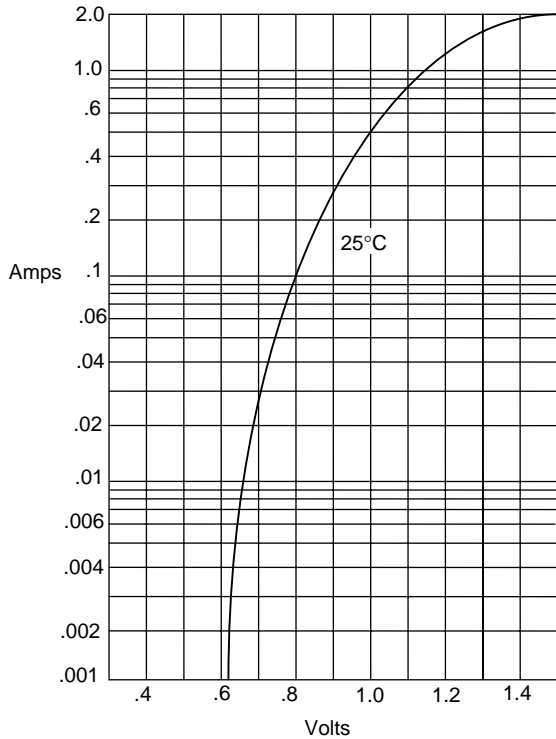
0.5 Amp Super Fast Recovery Rectifier 100 to 600 Volts



MURX0510 thru MURX0560

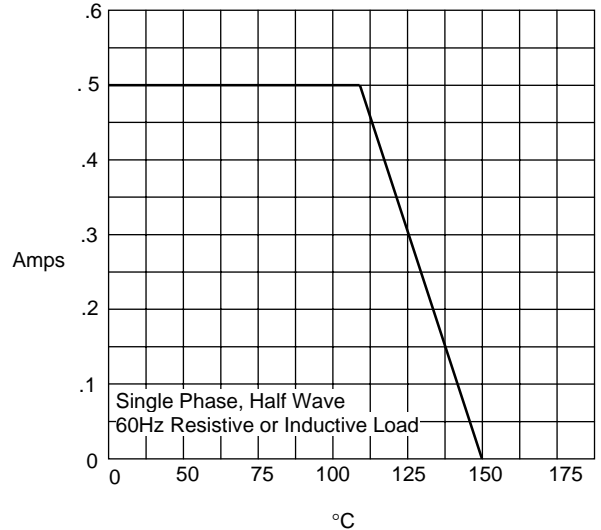


Figure 1
Typical Forward Characteristics



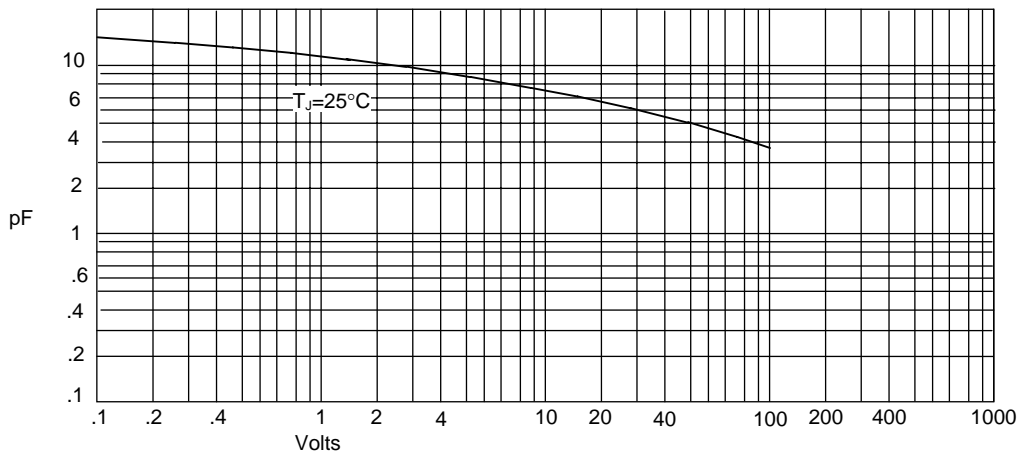
Instantaneous Forward Current - Amperes versus
Instantaneous Forward Voltage - Volts

Figure 2
Forward Derating Curve



Average Forward Rectified Current - Amperes versus
Ambient Temperature - °C

Figure 3
Junction Capacitance



Junction Capacitance - pF versus
Reverse Voltage - Volts

MURX0510 thru MURX0560

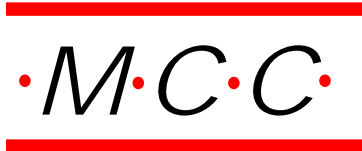
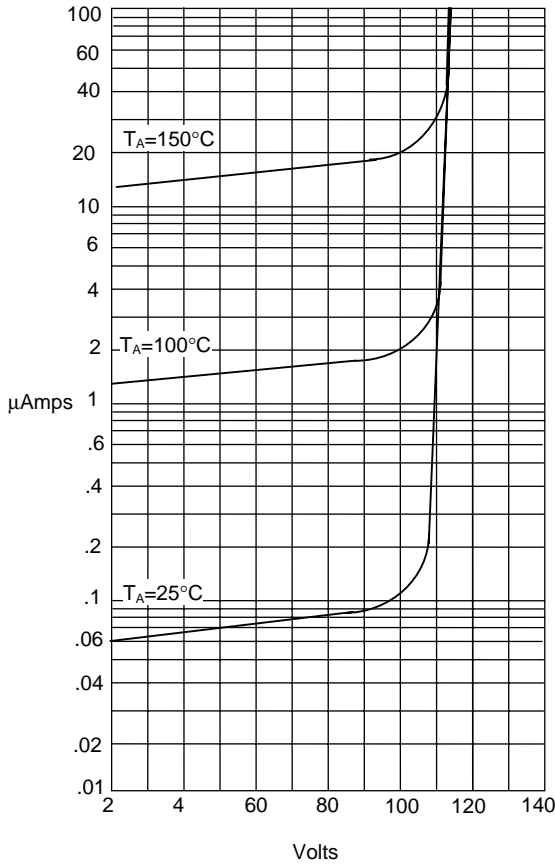
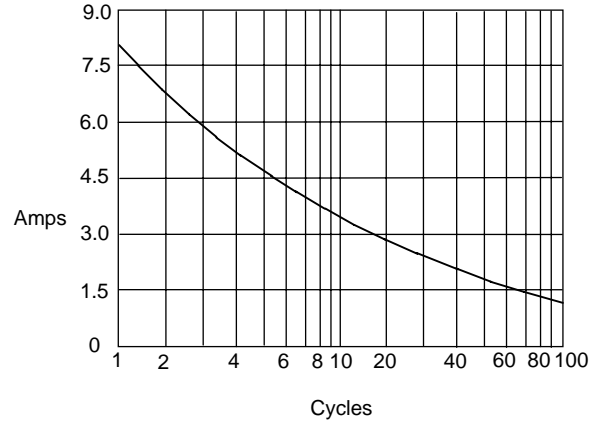


Figure 4
Typical Reverse Characteristics



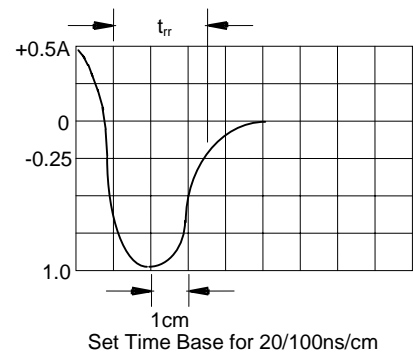
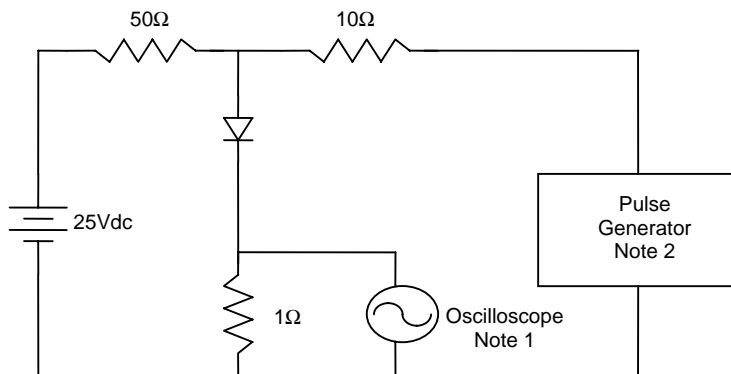
Instantaneous Reverse Leakage Current - MicroAmperes versus
Percent Of Rated Peak Reverse Voltage - Volts

Figure 5
Peak Forward Surge Current



Peak Forward Surge Current - Amperes versus
Number Of Cycles At 60Hz - Cycles

Figure 6
Reverse Recovery Time Characteristic And Test Circuit Diagram



- Notes:
1. Rise Time = 7ns max.
Input impedance = 1 megohm, 22pF
 2. Rise Time = 10ns max.
Source impedance = 50 ohms
 3. Resistors are non-inductive