

MVL-914ASOLC	MVL-904ASOLC
MVL-914AUYLC	MVL-904AUYLC
MVL-914HUOLC	MVL-904HUOLC
MVL-914UOLC	MVL-904UOLC
MVL-914HUYLC	MVL-904HUYLC
MVL-914UYLC	MVL-904UYLC
MVL-914TUOLC	MVL-904TUOLC
MVL-914TUYLC	MVL-904TUYLC
MVL-914MTGC	MVL-904MTGC
MVL-914MSGC	MVL-904MSGC
MVL-914MBC	MVL-904MBC
MVL-914MW	MVL-904MW
MVL-914HW	MVL-904HW
MVL-914HTGC	MVL-904HTGC
MVL-914HSGC	MVL-904HSGC
MVL-914HBC	MVL-904HBC

Technical Data JACK LEDs

11/19/2003

Benefits

- Fewer LEDs Required
- Lowers Lighting System Cost

Features

- High Flux Output
- Designed for High Current Operation
- Low Thermal Resistance
- Low Profile
- Reliable
- Packaged in Tubes for Use with Automatic Insertion Equipment

Applications

- Automotive Exterior Lighting
- Electronic Signs and Signals
- Traffic Signal
- Sign

Outline Drawing

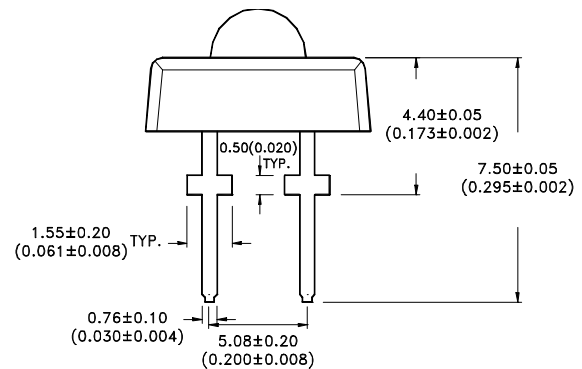
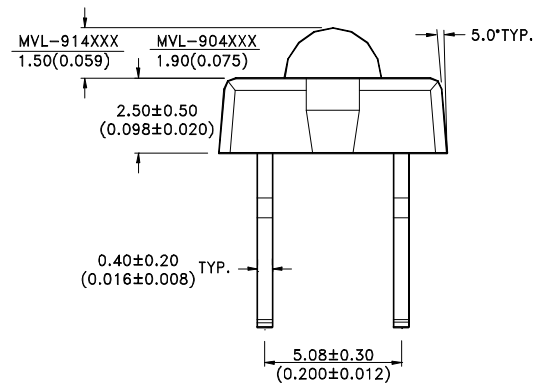
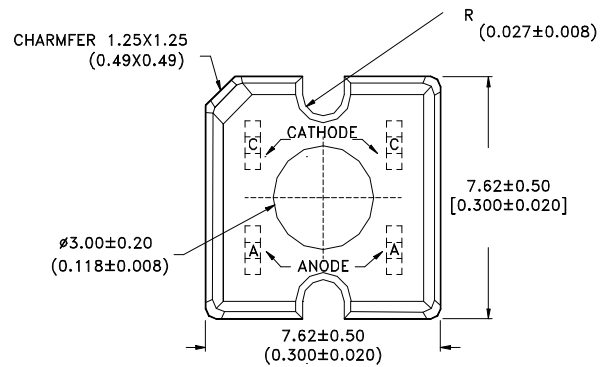

NOTES: 1. DIMENSIONS ARE IN MILLIMETERS (INCHES).
2. DIMENSIONS WITHOUT TOLERANCES ARE NOMINAL.

Device Selection Guide

Part Number	LED Color	Total Flux fv (mlm) Typ.	View Angle 2q1/2 (Degrees) Typ.
MVL-914HUOLC	AS AlInGaP Red-Orange	2500 @ I _F =70mA	70
MVL-904HUOLC			50
MVL-914UOLC		1700 @ I _F =50mA	70
MVL-904UOLC			50
MVL-914HUYLEC	AS AlInGaP Amber	2500 @ I _F =70mA	70
MVL-904HUYLEC			50
MVL-914UYLC		1700 @ I _F =50mA	70
MVL-904UYLC			50
MVL-914TUOLC	TS AlInGaP Red	3500 @ I _F =70mA	90
MVL-904TUOLC			70
MVL-914TUYLEC	TS AlInGaP Amber	3500 @ I _F =70mA	90
MVL-904TUYLEC			70
MVL-914MTGC	InGaN True Green	2000 @ I _F =40mA	70
MVL-904MTGC			50
MVL-914MSGC	InGaN Signal Green	1900 @ I _F =40mA	85
MVL-904MSGC			65
MVL-914MBC	InGaN Blue	1500 @ I _F =40mA	85
MVL-904MBC			65
MVL-914MW	White	4000 @ I _F =40mA	60
MVL-904MW			50
MVL-914HW	White	2000 @ I _F =20mA	60
MVL-904HW			50
MVL-914HTGC	InGaN True Green	1500 @ I _F =20mA	50
MVL-904HTGC			30
MVL-914HSGC	InGaN Signal Green	1200 @ I _F =20mA	70
MVL-904HSGC			50
MVL-914HBC	InGaN Blue	800 @ I _F =20mA	70
MVL-904HBC			50
MVL-914ASOLC	AS (OMA) AlInGaP Red Orange	4000 @ I _F =70mA	90
MVL-904ASOLC			70
MVL-914AUYLEC	AS (OMA) AlInGaP Amber	4000 @ I _F =70mA	90
MVL-904AUYLEC			70

Absolute Maximum Ratings at T_A=25°C

Device Type Parameter	MVL-9X4HUOLC MVL-9X4HUYLEC	MVL-9X4ASOLC MVL-9X4AUYLEC MVL-9X4TUOLC MVL-9X4TUYLEC	MVL-9X4UOLC MVL-9X4UYLC	MVL-9X4MTGC MVL-9X4MSGC MVL-9X4MBC MVL-9X4MW	MVL-9X4HTGC MVL-9X4HSGC MVL-9X4HBC MVL-9X4HW	Units
	DC Forward Current	70	70	50	40	
Power Dissipation	150	182	120	140	74	mW
Reverse Voltage (I _R =100μA)	10	10	10	5	5	V
LED Junction Temp.	125	125	125	125	125	°C
Operating Temp. Range	-20 to +80					°C
Storage Temp.	-30 to +100					°C
Solder Conditions						
Preheat Temperature	100°C for 30 seconds					
Solder Temperature	260°C for 5 seconds [1.5mm (0.06 in.) below seating plane]					

Optical Characteristics at T_A=25°C

Part Number	Total Flux f _v (mlm)		Peak Wavelength λ peak (nm) Typ.	Color, Dominant Wavelength λ d (nm) Typ.	Lumious Intensity Total Flux I _v (mcd)/f _v (mlm) Typ.	Viewing Angle 2q 1/2 (Degrees) Typ.
	Min.	Typ.				
MVL-914HUOLC	600 @ I _F =70mA	2500 @ I _F =70mA	630	625	0.560	70
MVL-904HUOLC						
MVL-914HUYLC	600 @ I _F =70mA	2500 @ I _F =70mA	592	590	0.437	70
MVL-904HUYLC						
MVL-914TUOLC	600 @ I _F =70mA	3500 @ I _F =70mA	640	630	0.281	90
MVL-904TUOLC						
MVL-914TUYLC	600 @ I _F =70mA	3500 @ I _F =70mA	594	592	0.228	90
MVL-904TUYLC						
MVL-914UOLC	600 @ I _F =50mA	1700 @ I _F =50mA	630	625	0.560	70
MVL-904UOLC						
MVL-914UYLC	600 @ I _F =50mA	1700 @ I _F =50mA	592	590	0.560	70
MVL-904UYLC						
MVL-914MTGC	1000 @ I _F =40mA	2000 @ I _F =40mA	523	525	0.595	70
MVL-904MTGC						
MVL-914MSGC	900 @ I _F =40mA	1900 @ I _F =40mA	502	505	0.457	85
MVL-904MSGC						
MVL-914MBC	900 @ I _F =40mA	1500 @ I _F =40mA	468	470	0.187	85
MVL-904MBC						
MVL-914HTGC	200 @ I _F =20mA	1500 @ I _F =20mA	523	525	0.595	50
MVL-904HTGC						
MVL-914HSGC	200 @ I _F =20mA	1200 @ I _F =20mA	502	505	0.457	70
MVL-904HSGC						
MVL-914HBC	200 @ I _F =20mA	800 @ I _F =20mA	468	470	0.187	70
MVL-904HBC						
MVL-914ASOLC	1500 @ I _F =70mA	4000 @ I _F =70mA	624	615	0.615	90
MVL-904ASOLC						
MVL-914AUYLEC	1500 @ I _F =70mA	4000 @ I _F =70mA	594	590	0.412	90
MVL-904AUYLEC						

Part Number	Total Flux f _v (mlm)		Chromaticity Coordinates (Typ.)	
	Min.	Typ.	X	Y
MVL-914MW	600 @ I _F =40mA	4000 @ I _F =40mA	0.33	0.31
MVL-904MW				
MVL-914HW	300 @ I _F =20mA	2000 @ I _F =20mA	0.33	0.31
MVL-904HW				

Electrical Characteristics at T_A=25°C

Device Type	Forward Voltage V _F (Volts)			Reverse Breakdown V _R (Volts) @ I _R =100mA		Thermal Resistance R _{qJ-PIN} (°C/W) Typ.	Thermal Resistance R _{qJ-A} (°C/W) Typ.
	Min.	Typ.	Max	Min.	Typ.		
MVL-9X4HUOLC	1.83	2.2	2.79	10	20	120	250
MVL-9X4HUYLC		@ I _F =70mA					
MVL-9X4UOLC	1.83	2.15	2.79	10	20	120	250
MVL-9X4UYLEC		@ I _F =50mA					
MVL-9X4TUOLC	2.07	2.5	3.15	10	20	125	250
MVL-9X4TUYLC		@ I _F =70mA					
MVL-9X4ASOLC	3	3.7	5.2	5	10	90	180
MVL-9X4AUYLEC		@ I _F =40mA					
MVL-9X4MTGC	3	3.7	4.0	5	10	90	180
MVL-9X4MSGC		@ I _F =20mA					
MVL-9X4MBC	3	3.7	4.0	5	10	90	180
MVL-9X4MW		@ I _F =20mA					
MVL-9X4HTGC	3	3.7	4.0	5	10	90	180
MVL-9X4HSGC		@ I _F =20mA					
MVL-9X4HBC	3	3.7	4.0	5	10	90	180
MVL-9X4HW		@ I _F =20mA					

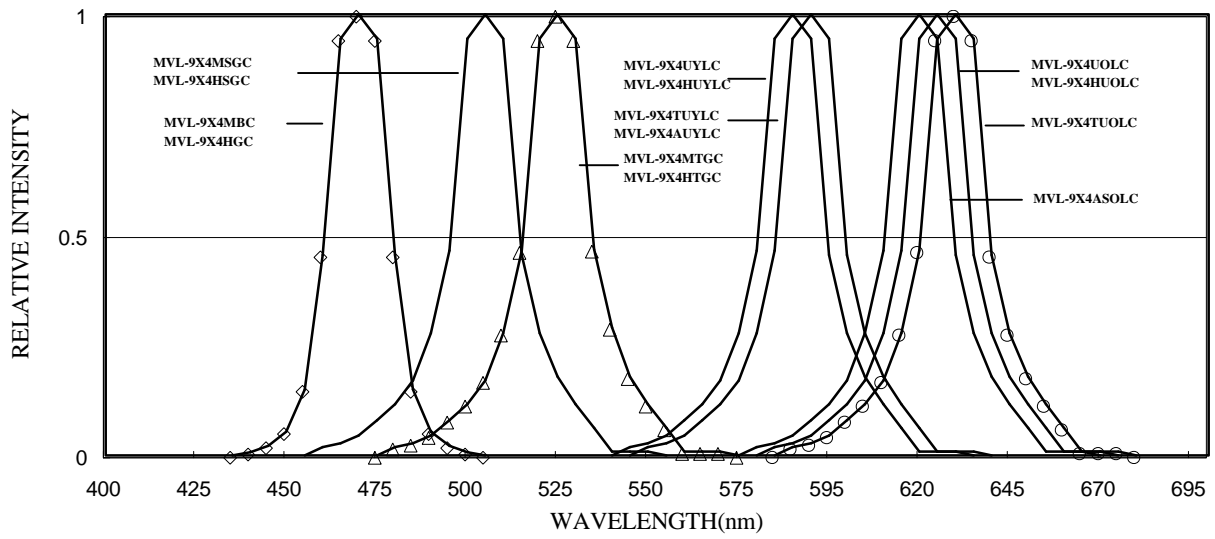

Figure 1. Relative Intensity vs. Wavelength.

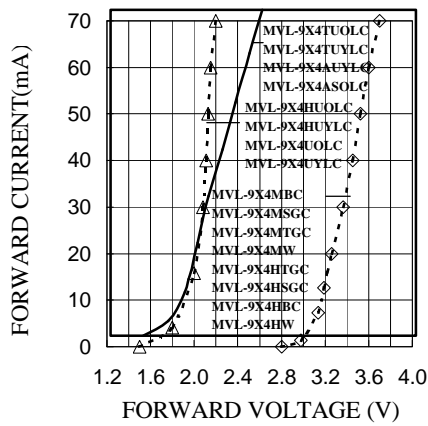

Figure 2. Forward Current vs. Forward Voltage.

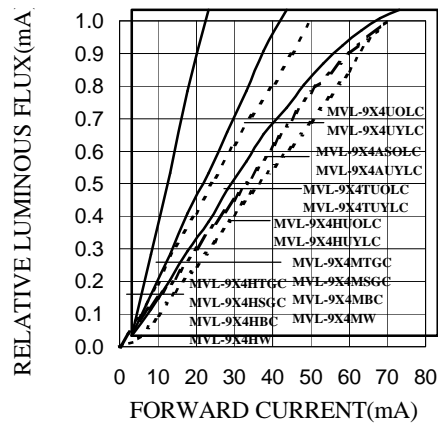

Figure 3. Relative Luminous Flux vs. Forward Current.

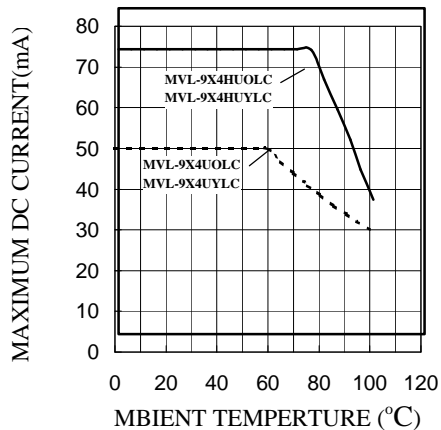

Figure 4a. Maximum DC Forward Current vs. Ambient Temperature.

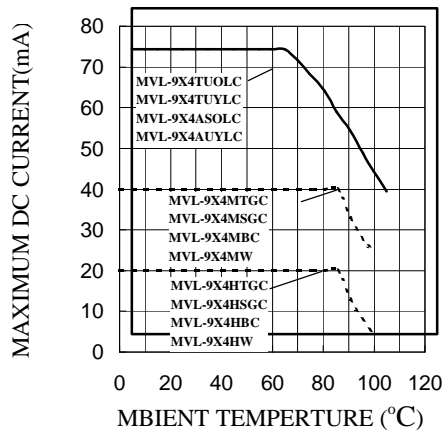

Figure 4b. Maximum DC Forward Current vs. Ambient Temperature.

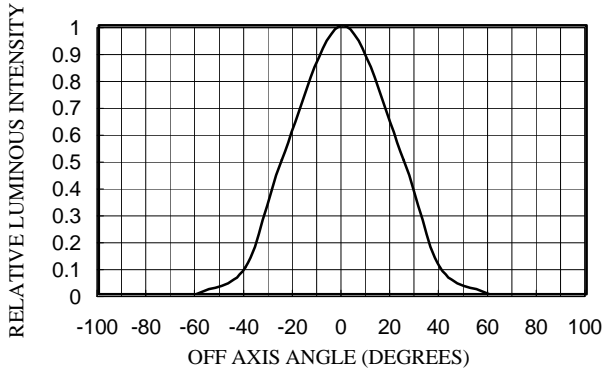

Figure 5. MVL-904HUOLC/MVL-904HUYLC/MVL-904UOLC/
MVL-904UYLC/MVL904MTGC/MVL-904HSGC/MVL-904MW
MVL-904HW/MVL-904HBC/MVL-914HTGC
Relative Luminous Intensity vs. Off Axis Angle.

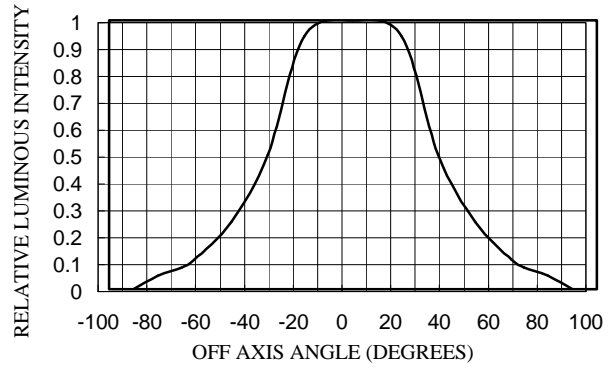

Figure 6. MVL-914HUOLC/MVL-914HUYLC/MVL-904TUOLC/
MVL-904TUYLC/MVL-914UOLC/MVL-914UYLC/
MVL-914MTGC/MVL-914HSGC/MVL-914HBC/
MVL-904ASOLC/MVL-904AUYLEC
Relative Luminous Intensity vs. Off Axis Angle.

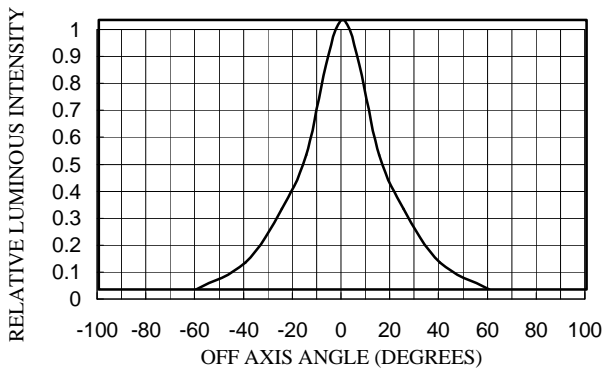

Figure 7. MVL-904HTGC
Relative Luminous Intensity vs. Off Axis Angle.

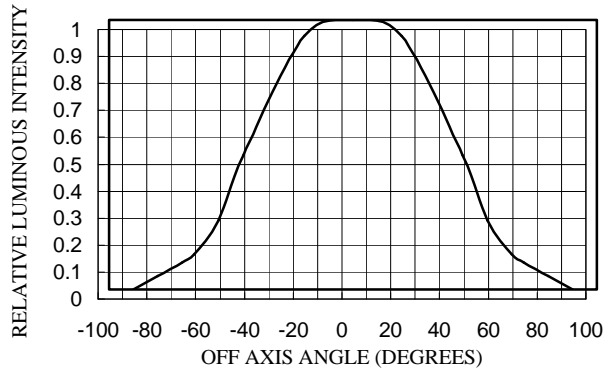

Figure 8. MVL-914TUOLC/MVL-914TUYLC/
MVL-914ASOLC/MVL-914AUYLEC
Relative Luminous Intensity vs. Off Axis Angle.

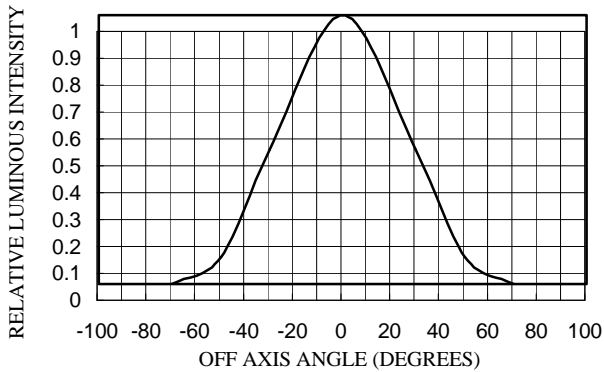

Figure 9. MVL-914MW/MVL-914HW
Relative Luminous Intensity vs. Off Axis Angle.

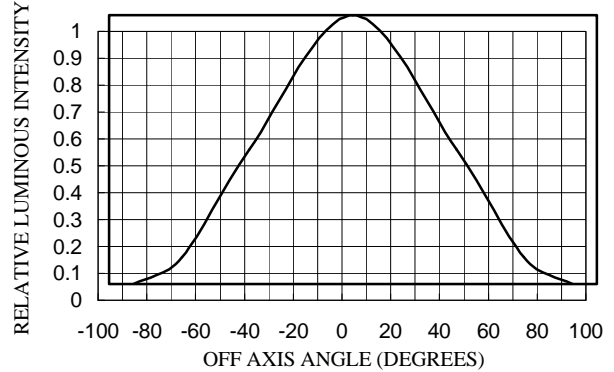

Figure 10. MVL-914MSGC/MVL-914MBC
Relative Luminous Intensity vs. Off Axis Angle.

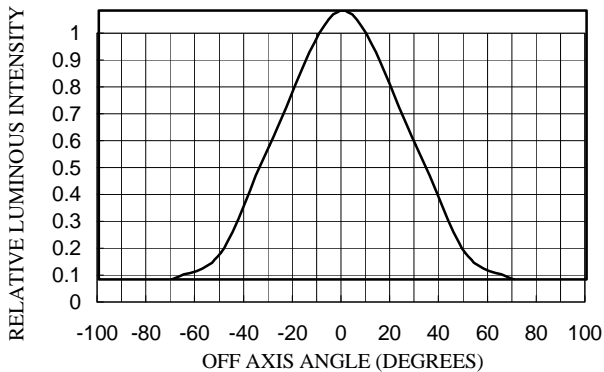

Figure 9. MVL-904MSGC/MVL-904MBC
Relative Luminous Intensity vs. Off Axis Angle.

Packaging

Tubes of LEDs

LEDs are packaged in tubes , each of which contains 60 LEDs.

The LEDs in any individual tube come from a single category code.

Figure 1. Shows a sample label taken from a tube.

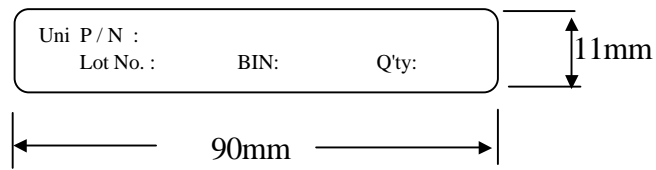

Boxes of LEDs

Each box of LEDs contains 240 tubes , or 14400 LEDs.

The box dimensions are 500× 243×150mm(L×W×H)

All of the tubes are in the same orientation .

Figure 2. Shows a sample label taken from a box .

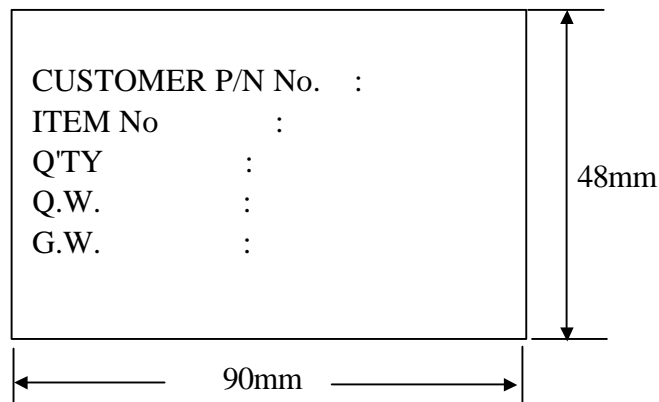

Unity JACK LED Bin Codes

Category Code		
C	2	3

Luminous Flux (Light-output in lumens)				
	MVL-9X4HUOLC MVL-9X4HUYLEC MVL-9X4TUOLC MVL-9X4TUYLC MVL-9X4ASOLC MVL-9X4AUYLEC @I _F =70mA		MVL-9X4MTGC MVL-9X4MSGC MVL-9X4MBC @I _F =40mA	
	MVL-9X4UOLC MVL-9X4UYLEC @I _F =50mA		MVL-9X4HTGC MVL-9X4HSGC MVL-9X4HBC @I _F =20mA	
BIN CODE	Minimum	Maximum	Minimum	Maximum
A	0.6	1.2	0.1	0.9
B	1.0	1.8	0.5	1.4
C	1.5	2.4	1.0	1.9
D	2.0	3.0	1.5	2.4
E	2.5	3.6	2.0	2.9
F	3.0	4.2	2.5	3.0
G	3.5	4.8		
H	4.0	5.45		
I	4.5	6.1		
J	5.0	6.7		
K	5.5	7.3		

Dominant Wavelength (in nanometers) @I _F =20mA										
BIN CODE	TUOLC , HUOLC UOLC , ASOLC		TUYLC , HUYLC UYLC , AUYLEC		MTGC HTGC		MSGC HSGC		MBC HBC	
	Minimum	Maximum	Minimum	Maximum	Minimum	Maximum	Minimum	Maximum	Minimum	Maximum
1	611	618	583	589	517	528	495	504	459	469
2	614	622	587	593	524	535	500	509	467	475
3	616	634	591	597	531	542	505	514	471	481

Forward Voltage (Volts)				
	MVL-9X4HUOLC MVL-9X4HUYLEC MVL-9X4TUOLC MVL-9X4TUYLC MVL-9X4ASOLC MVL-9X4AUYLEC @I _F =70mA		MVL-9X4MTGC MVL-9X4MSGC MVL-9X4MBC @I _F =40mA	
	MVL-9X4UOLC MVL-9X4UYLEC @I _F =50mA		MVL-9X4HTGC MVL-9X4HSGC MVL-9X4HBC @I _F =20mA	
BIN CODE	Minimum	Maximum	Minimum	Maximum
0	1.83	2.07	3.0	3.4
1	1.95	2.19	3.2	3.6
2	2.07	2.31	3.4	3.8
3	2.19	2.43	3.6	4.0
4	2.31	2.55	3.8	4.2
5	2.43	2.67	4.0	4.4
6	2.55	2.79	4.2	4.6
7	2.67	2.91	4.4	4.8
8	2.79	3.03	4.6	5.0
9	2.91	3.15	4.8	5.2

Unity JACK White LED Bin Codes

Category Code		
C	A	3

Luminous Flux (Light-output in lumens)		
	MVL-9X4MW @I _F =40mA MVL-9X4HW @I _F =20mA	
BIN CODE	Minimum	Maximum
A	0.6	1.2
B	1.0	1.8
C	1.5	2.4
D	2.0	3.0
E	2.5	3.6
F	3.0	4.2
G	3.5	4.8
H	4.0	5.45
I	4.5	6.1
J	5.0	6.7
K	5.5	7.3
L	6.0	7.9
M	6.5	8.5
N	7.0	9.1
O	7.5	9.7

Chromaticity Coordinates @I _F =20mA								
BIN CODE	1		2		3		4	
	X	Y	X	Y	X	Y	X	Y
A	0.264	0.317	0.273	0.336	0.273	0.286	0.264	0.267
B	0.273	0.336	0.283	0.353	0.283	0.305	0.273	0.286
C	0.264	0.267	0.273	0.286	0.288	0.262	0.280	0.248
D	0.273	0.286	0.283	0.305	0.296	0.276	0.288	0.262
E	0.283	0.345	0.306	0.372	0.306	0.352	0.283	0.325
F	0.306	0.372	0.330	0.400	0.330	0.380	0.306	0.352
G	0.285	0.325	0.306	0.352	0.306	0.332	0.283	0.305
H	0.306	0.352	0.330	0.380	0.330	0.360	0.306	0.332
I	0.283	0.305	0.306	0.332	0.308	0.317	0.287	0.295
J	0.306	0.332	0.330	0.360	0.330	0.339	0.308	0.317
K	0.287	0.295	0.308	0.317	0.313	0.297	0.296	0.276
L	0.308	0.317	0.330	0.339	0.330	0.318	0.313	0.297
M	0.296	0.276	0.313	0.297	0.313	0.277	0.296	0.256
N	0.313	0.297	0.330	0.318	0.330	0.298	0.313	0.277
O	0.330	0.390	0.345	0.402	0.345	0.372	0.330	0.360
P	0.345	0.402	0.361	0.415	0.361	0.385	0.345	0.372
Q	0.330	0.360	0.345	0.372	0.345	0.334	0.330	0.318
R	0.345	0.372	0.361	0.385	0.361	0.351	0.345	0.334

Tolerance : ± 0.01

Forward Voltage (Volts)		
	MVL-9X4MW @I _F =40mA MVL-9X4HW @I _F =20mA	
BIN CODE	Minimum	Maximum
0	3.0	3.4
1	3.2	3.6
2	3.4	3.8
3	3.6	4.0
4	3.8	4.2
5	4.0	4.4
6	4.2	4.6
7	4.4	4.8
8	4.6	5.0
9	4.8	5.2