

LOW VOLTAGE C-MOS OPERATIONAL AMPLIFIER

■ GENERAL DESCRIPTION

The NJU7001, 02 and 04 are single, dual and quad C-MOS Operational Amplifiers operated on a single-power-supply, low voltage and low operating current.

The minimum operating voltage is 1V and the output stage permits output signals to swing between both of the supply rails.

The input bias current is as low as less than 1pA, consequently the very small signal around the ground level can be amplified.

Furthermore, the operating current is also as low as 15 μA(typ) per circuit, therefore it can be applied especially to battery operated items.

■ FEATURES

- Single-Power-Supply
 - Wide Operating Voltage (V_{DD}=1~16V)
 - Wide Output Swing Range (V_{OM}=2.94V typ. at V_{DD}=3V)
 - Low Operating Current (15 μA/circuit)
 - Low Bias Current (I_{in}=1pA)
 - Internal Compensation Capacitor
 - External Offset Null Adjustment (Only NJU7001)
 - Package Outline
- DIP/DMP/SSOP 8 (NJU7001)
DIP/DMP 8 (NJU7002)
DIP/DMP/SSOP 14 (NJU7004)
- C-MOS Technology

■ PACKAGE OUTLINE

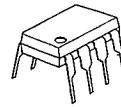

NJU7001B
NJU7002D



NJU7001M
NJU7002M

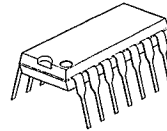

NJU7004D

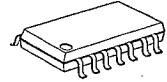

NJU7004M



NJU7001V

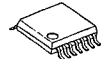

NJU7004V

■ PIN CONFIGURATION

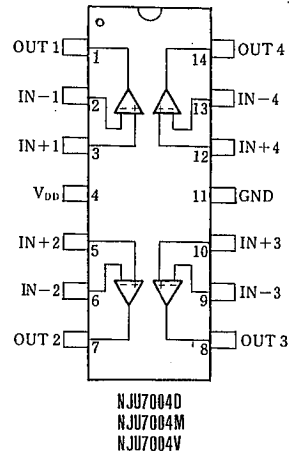
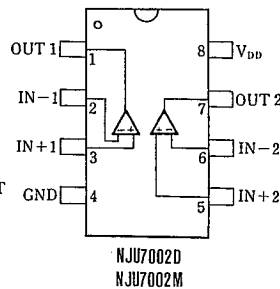
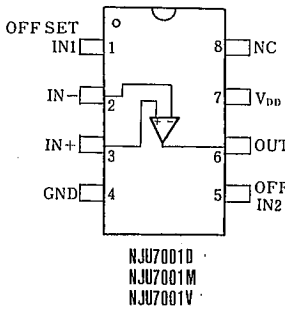

■ EQUIVALENT CIRCUIT

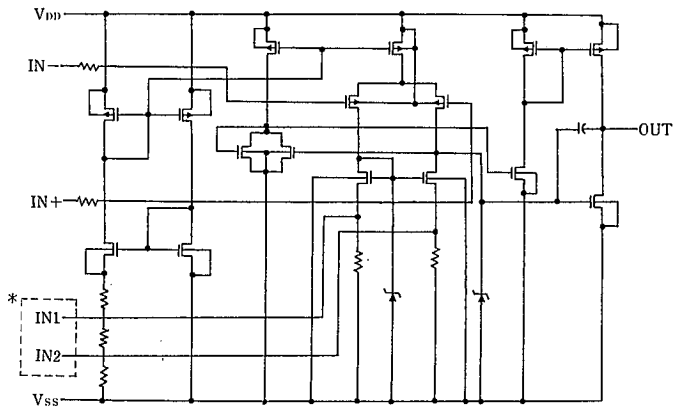

* IN1, IN2 are only for NJU7001(NJU7002/04 don't have these terminals).

4

■ ABSOLUTE MAXIMUM RATINGS

($T_a=25^\circ\text{C}$)

PARAMETER	SYMBOL	RATINGS	UNIT
Supply Voltage	V_{DD}	18	V
Differential Input Voltage	V_{ID}	± 18 *1	V
Common Mode Input Voltage	V_{IC}	-0.3~18	V
Power Dissipation	P_D	(DIP14) 700 (DIP8) 500 (DMP8,14) 300 (SSOP8,14) 300	mW
Operating Temperature	T_{opr}	-20~+75	$^\circ\text{C}$
Storage Temperature	T_{stg}	-40~+125	$^\circ\text{C}$

* 1) If the supply voltage (V_{DD}) is less than 18V, the input voltage must not over the V_{DD} level though 18V is limit specified.

■ ELECTRICAL CHARACTERISTICS

($T_a=25^\circ\text{C}$, $V_{DD}=3\text{V}$, $R_L=\infty$)

PARAMETER	SYMBOL	CONDITIONS	MIN.	TYP.	MAX.	UNIT
Input Offset Voltage	V_{IO}	$R_S=50\Omega$			10	mV
Input Offset Current	I_{IO}			1		pA
Input Bias Current	I_{IB}			1		pA
Input Impedance	R_{IN}			1		$\text{T}\Omega$
Large Signal Voltage Gain	A_v		80	90		dB
Input Common Mode Voltage Range	V_{ICM}		0~2			V
Maximum Output Swing Voltage	V_{OM}	$R_L=1\text{M}\Omega$	2.90	2.94		V
Common Mode Rejection Ratio	CMR		60	70		dB
Supply Voltage Rejection Ratio	SVR		60	70		dB
Operating Current / Circuit	I_{DD}			15	25	μA
Slew Rate	SR			0.05		$\text{V}/\mu\text{s}$
Unity Gain Bandwidth	F_t	$A_v=40\text{dB}$ $C_L=10\text{pF}$		0.1		MHz

■ OFFSET ADJUSTMENT CIRCUIT (ONLY FOR NJU7001)

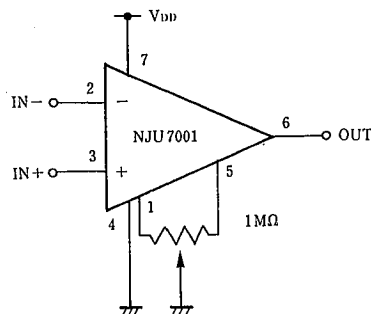

■ TYPICAL CHARACTERISTICS

Operating Current vs. Operating Voltage

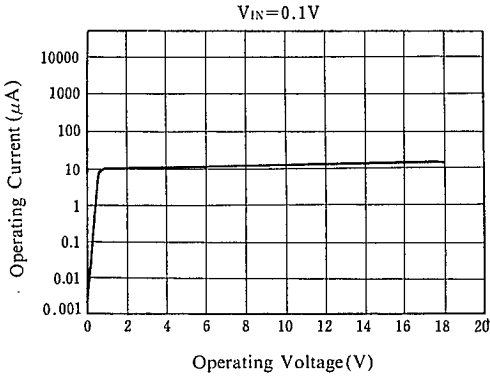

Offset Voltage vs. Operating Voltage

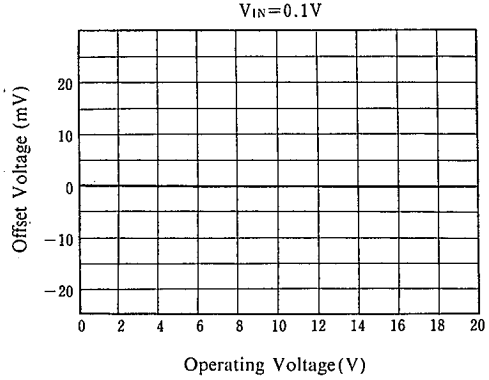

Output Current vs. Operating Voltage

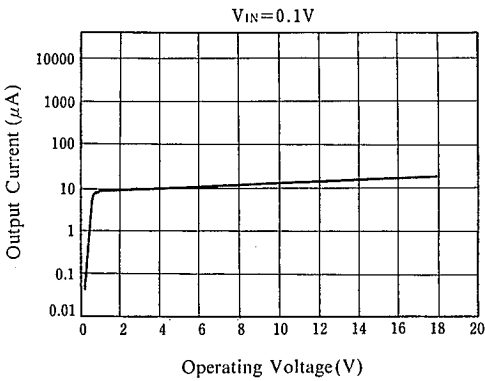

Offset Voltage vs. Input Voltage

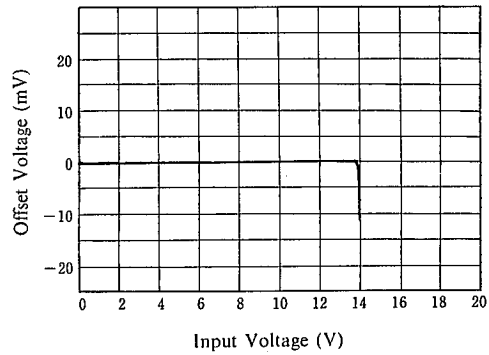

Output Voltage vs. Output Current

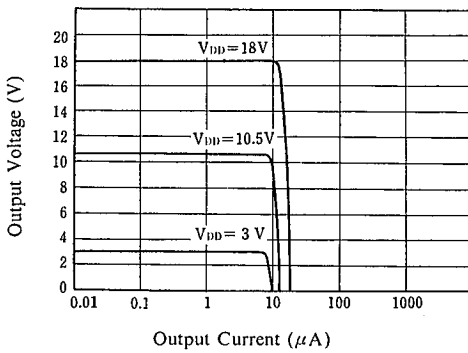

Maximum Output Swing Voltage vs. Frequency

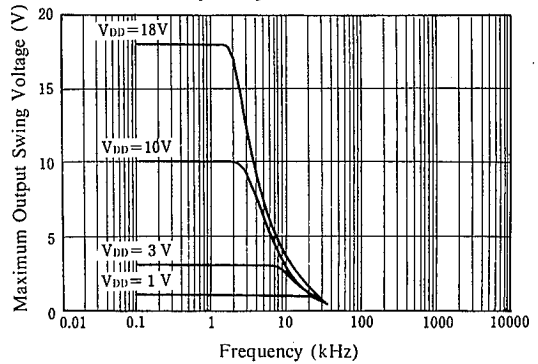

4

■ TYPICAL CHARACTERISTICS

Maximum Output Swing Voltage vs. Load Resistance

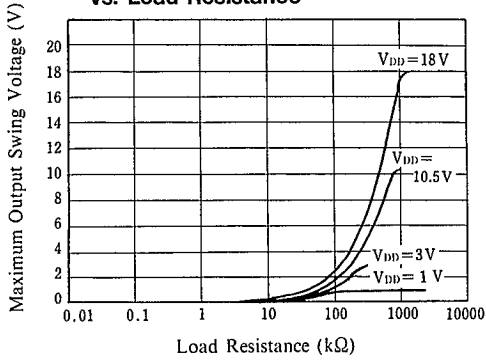

Voltage Gain • Phase vs. Frequency

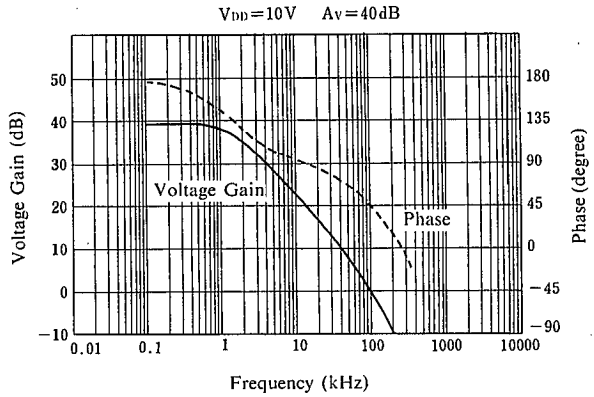

Equivalent Input Noise Voltage vs. Frequency

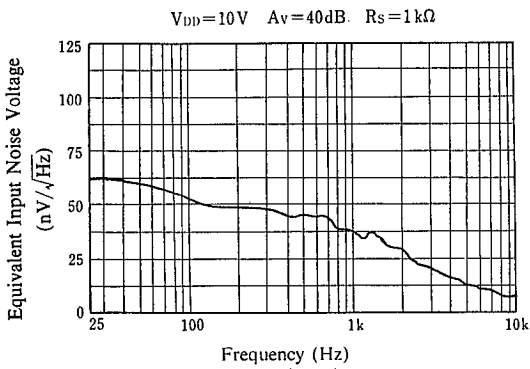

4

MEMO

[CAUTION]

The specifications on this databook are only given for information, without any guarantee as regards either mistakes or omissions. The application circuits in this databook are described only to show representative usages of the product and not intended for the guarantee or permission of any right including the industrial rights.