

# NSR20F20

## Schottky Barrier Diode

These Schottky barrier diodes are optimized for low forward voltage drop and low leakage current and are offered in a Chip Scale Package (CSP) to reduce board space. The low thermal resistance enables designers to meet the challenging task of achieving higher efficiency and meeting reduced space requirements.

### Features

- Low Forward Voltage Drop – 450 mV @ 2.0 A
- Low Reverse Current – 30  $\mu$ A @ 10 V VR
- 2.0 A of Continuous Forward Current
- Power Dissipation of 665 mW with Minimum Trace
- ESD Rating – Human Body Model: Class 3B  
– Machine Model: Class C
- High Switching Speed
- These Devices are Pb-Free, Halogen Free/BFR Free and are RoHS Compliant

### Typical Applications

- LCD and Keypad Backlighting
- Camera Photo Flash
- Buck and Boost dc–dc Converters
- Reverse Voltage and Current Protection
- Clamping & Protection

### Markets

- Mobile Handsets
- MP3 Players
- Digital Camera and Camcorders
- Notebook PCs & PDAs
- GPS

### MAXIMUM RATINGS

| Rating   | Symbol    | Value        | Unit    |
|--|-----------|--------------|---------|
| Reverse Voltage  | $V_R$     | 20           | V       |
| Forward Current (DC)   | $I_F$     | 2.0          | A       |
| Forward Surge Current (60 Hz @ 1 cycle)                                | $I_{FSM}$ | 28           | A       |
| Repetitive Peak Forward Current (Pulse Wave = 1 sec, Duty Cycle = 66%) | $I_{FRM}$ | 4.0          | A       |
| ESD Rating: Human Body Model<br>Machine Model                          | ESD       | > 8<br>> 400 | kV<br>V |

Stresses exceeding those listed in the Maximum Ratings table may damage the device. If any of these limits are exceeded, device functionality should not be assumed, damage may occur and reliability may be affected.



ON Semiconductor®

[www.onsemi.com](http://www.onsemi.com)

## 20 V SCHOTTKY BARRIER DIODE

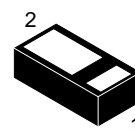

DSN2  
(0603)  
CASE 152AB

### MARKING DIAGRAM

PIN 1

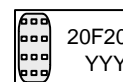

20F20 = Specific Device Code  
YYY = Year Code

### ORDERING INFORMATION

| Device        | Package           | Shipping†          |
|---------------|-------------------|--------------------|
| NSR20F20NXT5G | DSN2<br>(Pb-Free) | 5000 / Tape & Reel |

†For information on tape and reel specifications, including part orientation and tape sizes, please refer to our Tape and Reel Packaging Specifications Brochure, BRD8011/D.

# NSR20F20

## THERMAL CHARACTERISTICS

| Characteristic   | Symbol                   | Min | Typ | Max         | Unit                     |
|--|--------------------------|-----|-----|-------------|--------------------------|
| Thermal Resistance<br>Junction-to-Ambient (Note 1)<br>Total Power Dissipation @ $T_A = 25^\circ\text{C}$ | $R_{\theta JA}$<br>$P_D$ |     |     | 213<br>586  | $^\circ\text{C/W}$<br>mW |
| Thermal Resistance<br>Junction-to-Ambient (Note 2)<br>Total Power Dissipation @ $T_A = 25^\circ\text{C}$ | $R_{\theta JA}$<br>$P_D$ |     |     | 80<br>1.56  | $^\circ\text{C/W}$<br>W  |
| Storage Temperature Range  | $T_{stg}$                |     |     | -40 to +125 | $^\circ\text{C}$         |
| Junction Temperature   | $T_J$                    |     |     | +150        | $^\circ\text{C}$         |

1. Mounted onto a 4 in square FR-4 board 50 mm sq. 1 oz. Cu 0.06" thick single sided. Operating to steady state.
2. Mounted onto a 4 in square FR-4 board 1 in sq. 1 oz. Cu 0.06" thick single sided. Operating to steady state.

## ELECTRICAL CHARACTERISTICS ( $T_A = 25^\circ\text{C}$ unless otherwise noted)

| Characteristic   | Symbol   | Min | Typ            | Max            | Unit          |
|--|----------|-----|----------------|----------------|---------------|
| Reverse Leakage<br>( $V_R = 10\text{ V}$ )<br>( $V_R = 20\text{ V}$ )                            | $I_R$    |     |                | 30<br>150      | $\mu\text{A}$ |
| Forward Voltage<br>( $I_F = 1.0\text{ A}$ )<br>( $I_F = 2.0\text{ A}$ )                          | $V_F$    |     | 0.390<br>0.450 | 0.420<br>0.470 | V             |
| Reverse Recovery Time<br>( $I_F = I_R = 10\text{ mA}$ , $I_{R(REC)} = 1.0\text{ mA}$ , Figure 4) | $t_{rr}$ |     | 80             |                | ns            |

# NSR20F20

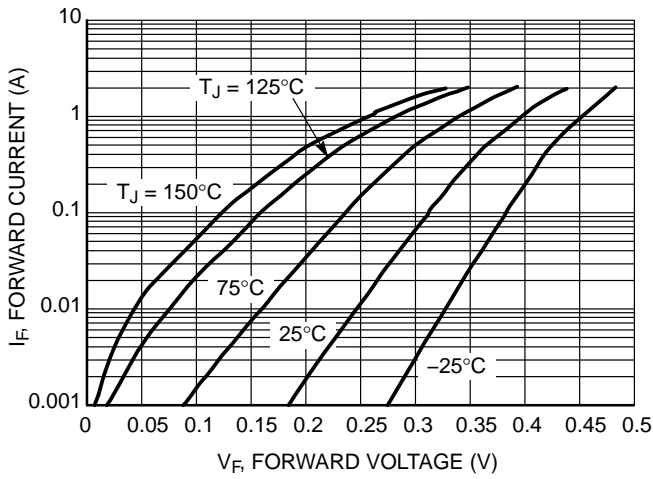

**Figure 1. Forward Voltage**

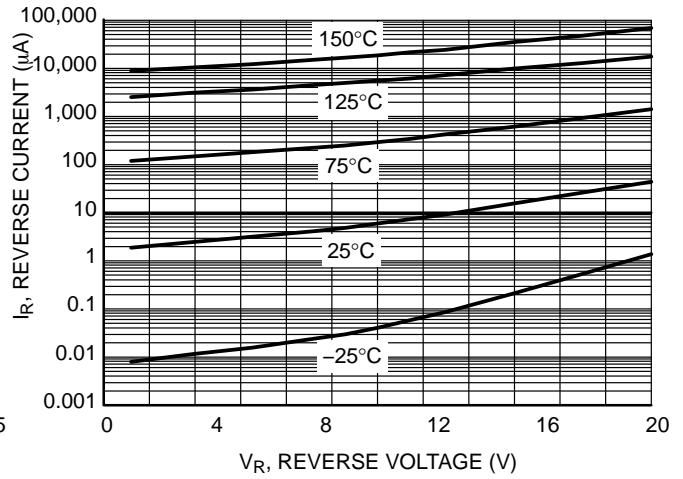

**Figure 2. Typical Reverse Current**

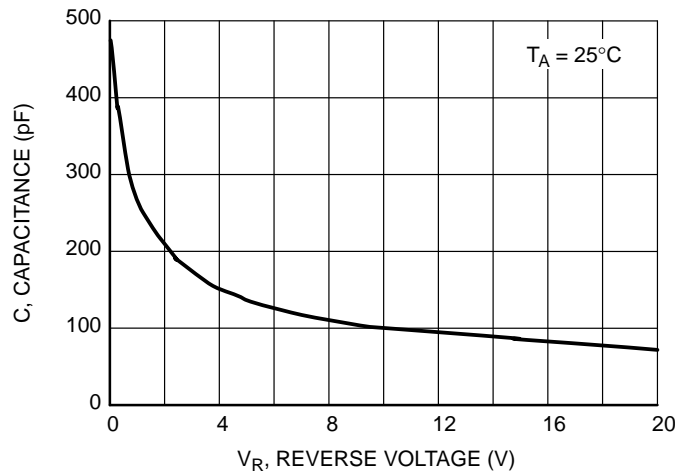

**Figure 3. Typical Capacitance**

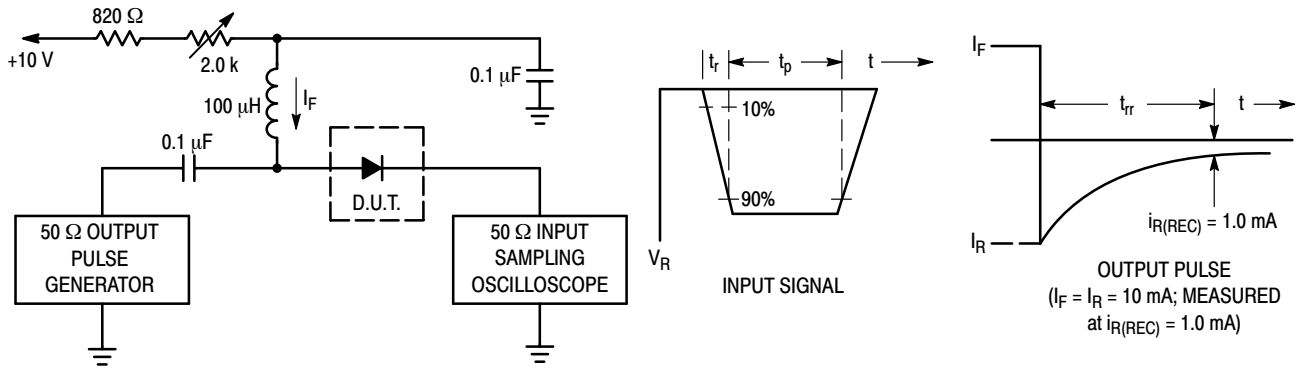

- Notes: 1. A 2.0 kΩ variable resistor adjusted for a Forward Current ( $I_F$ ) of 10 mA.
- 2. Input pulse is adjusted so  $I_{R(peak)}$  is equal to 10 mA.
- 3.  $t_p \gg t_{rr}$

**Figure 4. Recovery Time Equivalent Test Circuit**

# NSR20F20

## PACKAGE DIMENSIONS

DSN2, 1.6x0.8, 0.9P, (0603)  
CASE 152AB  
ISSUE B

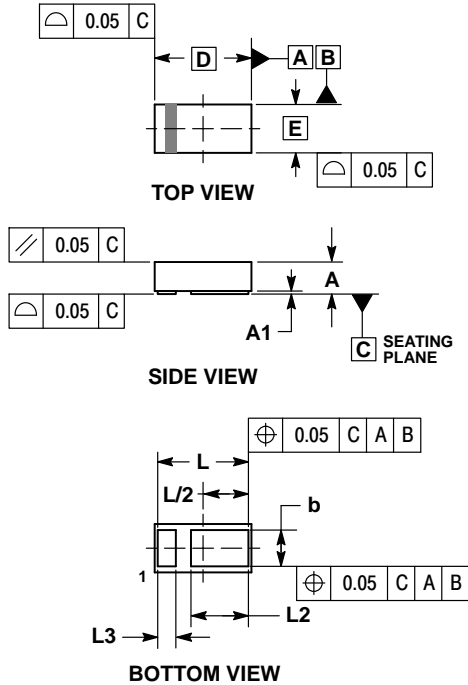

- NOTES:
1. DIMENSIONING AND TOLERANCING PER ASME Y14.5M, 1994.
  2. CONTROLLING DIMENSION: MILLIMETERS.

| DIM | MILLIMETERS |      |
|-----|-------------|------|
|     | MIN         | MAX  |
| A   | 0.25        | 0.31 |
| A1  | ---         | 0.05 |
| b   | 0.55        | 0.65 |
| D   | 1.60 BSC    |      |
| E   | 0.80 BSC    |      |
| L   | 1.45        | 1.55 |
| L2  | 0.90        | 1.00 |
| L3  | 0.25        | 0.35 |

### CATHODE BAND MONTH CODING

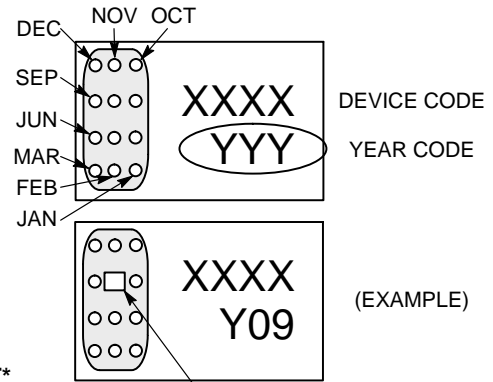

INDICATES AUG 2009

### MOUNTING FOOTPRINT\*

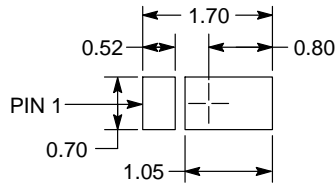

DIMENSIONS: MILLIMETERS

See Application Note AND8464/D for more mounting details

\*For additional information on our Pb-Free strategy and soldering details, please download the ON Semiconductor Soldering and Mounting Techniques Reference Manual, SOLDERRM/D.

ON Semiconductor and are registered trademarks of Semiconductor Components Industries, LLC (SCILLC). SCILLC owns the rights to a number of patents, trademarks, copyrights, trade secrets, and other intellectual property. A listing of SCILLC's product/patent coverage may be accessed at [www.onsemi.com/site/pdf/Patent-Marking.pdf](http://www.onsemi.com/site/pdf/Patent-Marking.pdf). SCILLC reserves the right to make changes without further notice to any products herein. SCILLC makes no warranty, representation or guarantee regarding the suitability of its products for any particular purpose, nor does SCILLC assume any liability arising out of the application or use of any product or circuit, and specifically disclaims any and all liability, including without limitation special, consequential or incidental damages. "Typical" parameters which may be provided in SCILLC data sheets and/or specifications can and do vary in different applications and actual performance may vary over time. All operating parameters, including "Typicals" must be validated for each customer application by customer's technical experts. SCILLC does not convey any license under its patent rights nor the rights of others. SCILLC products are not designed, intended, or authorized for use as components in systems intended for surgical implant into the body, or other applications intended to support or sustain life, or for any other application in which the failure of the SCILLC product could create a situation where personal injury or death may occur. Should Buyer purchase or use SCILLC products for any such unintended or unauthorized application, Buyer shall indemnify and hold SCILLC and its officers, employees, subsidiaries, affiliates, and distributors harmless against all claims, costs, damages, and expenses, and reasonable attorney fees arising out of, directly or indirectly, any claim of personal injury or death associated with such unintended or unauthorized use, even if such claim alleges that SCILLC was negligent regarding the design or manufacture of the part. SCILLC is an Equal Opportunity/Affirmative Action Employer. This literature is subject to all applicable copyright laws and is not for resale in any manner.

### PUBLICATION ORDERING INFORMATION

**LITERATURE FULFILLMENT:**  
Literature Distribution Center for ON Semiconductor  
P.O. Box 5163, Denver, Colorado 80217 USA  
Phone: 303-675-2175 or 800-344-3860 Toll Free USA/Canada  
Fax: 303-675-2176 or 800-344-3867 Toll Free USA/Canada  
Email: [orderlit@onsemi.com](mailto:orderlit@onsemi.com)

**N. American Technical Support:** 800-282-9855 Toll Free  
USA/Canada  
**Europe, Middle East and Africa Technical Support:**  
Phone: 421 33 790 2910  
**Japan Customer Focus Center**  
Phone: 81-3-5817-1050

**ON Semiconductor Website:** [www.onsemi.com](http://www.onsemi.com)  
**Order Literature:** <http://www.onsemi.com/orderlit>  
For additional information, please contact your local Sales Representative