

P6KE-G Series

Stand-off Voltage: 6.8 ~ 600V

Power Dissipation: 600 Watts

RoHS Device



Features

- Plastic package has underwriters laboratory flammability classification 94V-0
- 600W, surge capability at 1mS.
- Excellent clamping capability.
- Low Zener impedance.
- Fast response time: typically less than 1.0pS from 0 volt to BV min.
- Typical I_R less than 1 μ A above 10V.

Mechanical Data

- Epoxy: UL 94V-0 rate flame retardant
- Case: Molded plastic DO-15
- Terminals: Axial leads solderable per MIL-STD-202, Method 208
- Polarity: Color band denotes positive end (cathode)
- Weight: 0.4 grams

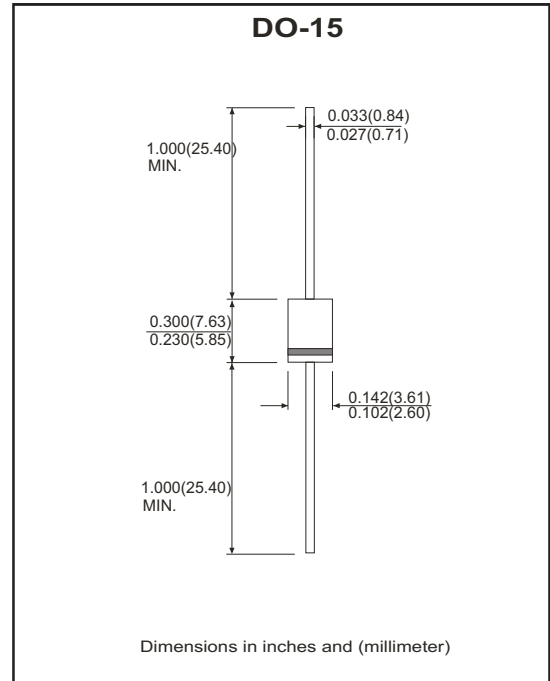

Maximum Ratings and Electrical Characteristics

Parameter	Symbol	Value	Unit
Peak power dissipation with a 10/1000 μ s waveform (Note 1)	P _{PP}	600	W
Peak pulse current with a 10/1000 μ s waveform (Note 1)	I _{PP}	See Next Table	A
Power dissipation on infinite heatsink at T _L =75 ^o C	P _D	5.0	W
Peak forward surge current, 8.3ms single half sine-wave unidirectional only (JEDEC method) (Note 2)	I _{FSM}	100	A
Maximum instantaneous forward voltage at 50 A for unidirectional only(Note 3)	V _F	3.5/5.0	V
Operating junction and storage temperature range	T _J , T _{STG}	-55 to +150	^o C

NTOES:

(1) Non-repetitive current pulse, per fig.5 and derated above TA=25 ^oC per fig. 1

(2) Measured on 8.3ms single half sine-wave or equivalent square wave, square wave, duty cycle=4 pulses per minute maximum

(3) V_F<3.5V for devices of V_{BR}<200V and V_F<5.0V for devices of V_{BR}>201V

600W Transient Voltage Suppressor



RATING AND CHARACTERISTIC (P6KE-G Series)

Part No.		Absolute Maximum Rating (Ta=25 °C)					Electrical Characteristics (Ta=25 °C)			Marking Code.	
Uni	Bi	V _{RWM}	V _{BR} Min.	V _{BR} Max.	I _T	I _{FSM}	Max. Vc @I _{PPM}		Max. I _R @V _{RWM}	Uni	Bi
		(V)	(V)	(V)	(mA)	(A)@8.3ms	(V)	I _{PPM} (A)	uA		
P6KE6.8-G	P6KE6.8C-G	5.5	6.12	7.48	10	100	10.8	55.56	1000	P6KE6.8	P6KE6.8C
P6KE6.8A-G	P6KE6.8CA-G	5.8	6.45	7.14	10	100	10.5	57.14	1000	P6KE6.8A	P6KE6.8CA
P6KE7.5-G	P6KE7.5C-G	6.1	6.75	8.25	10	100	11.7	51.28	500	P6KE7.5	P6KE7.5C
P6KE7.5A-G	P6KE7.5CA-G	6.4	7.13	7.88	10	100	11.3	53.10	500	P6KE7.5A	P6KE7.5CA
P6KE8.2-G	P6KE8.2C-G	6.6	7.38	9.02	10	100	12.5	48.00	200	P6KE8.2	P6KE8.2C
P6KE8.2A-G	P6KE8.2CA-G	7.0	7.79	8.61	10	100	12.1	49.59	200	P6KE8.2A	P6KE8.2CA
P6KE9.1-G	P6KE9.1C-G	7.4	8.19	10.01	1.0	100	13.8	43.48	50	P6KE9.1	P6KE9.1C
P6KE9.1A-G	P6KE9.1CA-G	7.8	8.65	9.56	1.0	100	13.4	44.78	50	P6KE9.1A	P6KE9.1CA
P6KE10-G	P6KE10C-G	8.1	9.00	11.00	1.0	100	15.0	40.00	10	P6KE10	P6KE10C
P6KE10A-G	P6KE10CA-G	8.6	9.50	10.50	1.0	100	14.5	41.38	10	P6KE10A	P6KE10CA
P6KE11-G	P6KE11C-G	8.9	9.90	12.10	1.0	100	16.2	37.04	5	P6KE11	P6KE11C
P6KE11A-G	P6KE11CA-G	9.4	10.45	11.55	1.0	100	15.6	38.46	5	P6KE11A	P6KE11CA
P6KE12-G	P6KE12C-G	9.7	10.80	13.20	1.0	100	17.3	34.68	5	P6KE12	P4KE12C
P6KE12A-G	P6KE12CA-G	10.2	11.40	12.60	1.0	100	16.7	35.93	5	P6KE12A	P6KE12CA
P6KE13-G	P6KE13C-G	10.5	11.70	14.30	1.0	100	19.0	31.58	5	P6KE13	P6KE13C
P6KE13A-G	P6KE13CA-G	11.1	12.35	13.65	1.0	100	18.2	32.97	5	P6KE13A	P6KE13CA
P6KE15-G	P6KE15C-G	12.1	13.50	16.50	1.0	100	22.0	27.27	5	P6KE15	P6KE15C
P6KE15A-G	P6KE15CA-G	12.8	14.25	15.75	1.0	100	21.2	28.30	5	P6KE15A	P6KE15CA
P6KE16-G	P6KE16C-G	12.9	14.40	17.60	1.0	100	23.5	25.53	5	P6KE16	P6KE16C
P6KE16A-G	P6KE16CA-G	13.6	15.20	16.80	1.0	100	22.5	26.67	5	P6KE16A	P6KE16CA
P6KE18-G	P6KE18C-G	14.5	16.20	19.80	1.0	100	26.5	22.64	5	P6KE18	P6KE18C
P6KE18A-G	P6KE18CA-G	15.3	17.10	18.90	1.0	100	25.2	23.81	5	P6KE18A	P6KE18CA
P6KE20-G	P6KE20C-G	16.2	18.00	22.00	1.0	100	29.1	20.62	5	P6KE20	P6KE20C
P6KE20A-G	P6KE20CA-G	17.1	19.00	21.00	1.0	100	27.7	21.66	5	P6KE20A	P6KE20CA
P6KE22-G	P6KE22C-G	17.8	19.80	24.20	1.0	100	31.9	18.81	5	P6KE22	P6KE22C
P6KE22A-G	P6KE22CA-G	18.8	20.90	23.10	1.0	100	30.6	19.61	5	P6KE22A	P6KE22CA
P6KE24-G	P6KE24C-G	19.4	21.60	26.40	1.0	100	34.7	17.29	5	P6KE24	P6KE24C
P6KE24A-G	P6KE24CA-G	20.5	22.80	25.20	1.0	100	33.2	18.07	5	P6KE24A	P6KE24CA
P6KE27-G	P6KE27C-G	21.8	24.30	29.70	1.0	100	39.1	15.35	5	P6KE27	P6KE27C
P6KE27A-G	P6KE27CA-G	23.1	25.65	28.35	1.0	100	37.5	16.00	5	P6KE27A	P6KE27CA
P6KE30-G	P6KE30C-G	24.3	27.00	33.00	1.0	100	43.5	13.79	5	P6KE30	P6KE30C
P6KE30A-G	P6KE30CA-G	25.6	28.50	31.50	1.0	100	41.4	14.49	5	P6KE30A	P6KE30CA
P6KE33-G	P6KE33C-G	26.8	29.70	36.30	1.0	100	47.7	12.58	5	P6KE33	P6KE33C
P6KE33A-G	P6KE33CA-G	28.2	31.35	34.65	1.0	100	45.7	13.13	5	P6KE33A	P6KE33CA
P6KE36-G	P6KE36C-G	29.1	32.40	39.60	1.0	100	52.0	11.54	5	P6KE36	P6KE36C
P6KE36A-G	P6KE36CA-G	30.8	34.20	37.80	1.0	100	49.9	12.02	5	P6KE36A	P6KE36CA
P6KE39-G	P6KE39C-G	31.6	35.10	42.90	1.0	100	56.4	10.64	5	P6KE39	P6KE39C
P6KE39A-G	P6KE39CA-G	33.3	37.05	40.95	1.0	100	53.9	11.13	5	P6KE39A	P6KE39CA
P6KE43-G	P6KE43C-G	34.8	38.70	47.30	1.0	100	61.9	9.69	5	P6KE43	P6KE43C
P6KE43A-G	P6KE43CA-G	36.8	40.85	45.15	1.0	100	59.3	10.12	5	P6KE43A	P6KE43CA
P6KE47-G	P6KE47C-G	38.1	42.30	51.70	1.0	100	67.8	8.85	5	P6KE47	P6KE47C
P6KE47A-G	P6KE47CA-G	40.2	44.65	49.35	1.0	100	64.8	9.26	5	P6KE47A	P6KE47CA
P6KE51-G	P6KE51C-G	41.3	45.90	56.10	1.0	100	73.5	8.16	5	P6KE51	P6KE51C
P6KE51A-G	P6KE51CA-G	43.6	48.45	53.55	1.0	100	70.1	8.56	5	P6KE51A	P6KE51CA

600W Transient Voltage Suppressor



RATING AND CHARACTERISTIC (P6KE-G Series)

Part No.		Absolute Maximum Rating (Ta=25 °C)					Electrical Characteristics (Ta=25 °C)			Marking Code.	
Uni	Bi	V _{RWM}	V _{BR} Min.	V _{BR} Max.	I _T	I _{FSM}	Max. Vc @I _{PPM}		Max. I _R @V _{RWM}	Uni	Bi
		(V)	(V)	(V)	(mA)	(A)@8.3ms	(V)	I _{PPM} (A)	uA		
P6KE56-G	P6KE56C-G	45.4	50.40	61.60	1.0	100	80.5	7.45	5	P6KE56	P6KE56C
P6KE56A-G	P6KE56CA-G	47.8	53.20	58.80	1.0	100	77.0	7.79	5	P6KE56A	P6KE56CA
P6KE62-G	P6KE62C-G	50.2	55.80	68.20	1.0	100	89.0	6.74	5	P6KE62	P6KE62C
P6KE62A-G	P6KE62CA-G	53.0	58.90	65.10	1.0	100	85.0	7.06	5	P6KE62A	P6KE62CA
P6KE68-G	P6KE68C-G	55.1	61.20	74.80	1.0	100	98.0	6.12	5	P6KE68	P6KE68C
P6KE68A-G	P6KE68CA-G	58.1	64.60	71.40	1.0	100	92.0	6.52	5	P6KE68A	P6KE68CA
P6KE75-G	P6KE75C-G	60.7	67.50	82.50	1.0	100	108.0	5.56	5	P6KE75	P6KE75C
P6KE75A-G	P6KE75CA-G	64.1	71.25	78.75	1.0	100	103.0	5.83	5	P6KE75A	P6KE75CA
P6KE82-G	P6KE82C-G	66.4	73.80	90.20	1.0	100	118.0	5.08	5	P6KE82	P6KE82C
P6KE82A-G	P6KE82CA-G	70.1	77.90	86.10	1.0	100	113.0	5.31	5	P6KE82A	P6KE82CA
P6KE91-G	P6KE91C-G	73.7	81.90	100.10	1.0	100	131.0	4.58	5	P6KE91	P6KE91C
P6KE91A-G	P6KE91CA-G	77.8	86.45	95.55	1.0	100	125.0	4.80	5	P6KE91A	P6KE91CA
P6KE100-G	P6KE100C-G	81.0	90.00	110.00	1.0	100	144.0	4.17	5	P6KE100	P6KE100C
P6KE100A-G	P6KE100CA-G	85.5	95.00	105.00	1.0	100	137.0	4.38	5	P6KE100A	P6KE100CA
P6KE110-G	P6KE110C-G	89.2	99.00	121.00	1.0	100	158.0	3.80	5	P6KE110	P6KE110C
P6KE110A-G	P6KE110CA-G	96.0	104.50	115.50	1.0	100	152.0	3.95	5	P6KE110A	P6KE110CA
P6KE120-G	P6KE120C-G	97.2	108.00	132.00	1.0	100	173.0	3.47	5	P6KE120	P6KE120C
P6KE120A-G	P6KE120CA-G	102.0	114.00	126.00	1.0	100	165.0	3.64	5	P6KE120A	P6KE120CA
P6KE130-G	P6KE130C-G	105.0	117.00	143.00	1.0	100	187.0	3.21	5	P6KE130	P6KE130C
P6KE130A-G	P6KE130CA-G	111.0	123.50	136.50	1.0	100	179.0	3.35	5	P6KE130A	P6KE130CA
P6KE150-G	P6KE150C-G	121.0	135.00	165.00	1.0	100	215.0	2.79	5	P6KE150	P6KE150C
P6KE150A-G	P6KE150CA-G	128.0	142.50	157.50	1.0	100	207.0	2.90	5	P6KE150A	P6KE150CA
P6KE160-G	P6KE160C-G	130.0	144.00	176.00	1.0	100	230.0	2.61	5	P6KE160	P6KE160C
P6KE160A-G	P6KE160CA-G	136.0	152.00	168.00	1.0	100	219.0	2.74	5	P6KE160A	P6KE160CA
P6KE170-G	P6KE170C-G	138.0	153.00	187.00	1.0	100	244.0	2.46	5	P6KE170	P6KE170C
P6KE170A-G	P6KE170CA-G	145.0	161.50	178.50	1.0	100	234.0	2.56	5	P6KE170A	P6KE170CA
P6KE180-G	P6KE180C-G	146.0	162.00	198.00	1.0	100	258.0	2.33	5	P6KE180	P6KE180C
P6KE180A-G	P6KE180CA-G	154.0	171.00	289.00	1.0	100	246.0	2.44	5	P6KE180A	P6KE180CA
P6KE200-G	P6KE200C-G	162.0	180.00	220.00	1.0	100	287.0	2.09	5	P6KE200	P6KE200C
P6KE200A-G	P6KE200CA-G	171.0	190.00	210.00	1.0	100	274.0	2.19	5	P6KE200A	P6KE200CA
P6KE220-G	P6KE220C-G	175.0	198.00	242.00	1.0	100	344.0	1.74	5	P6KE220	P6KE220C
P6KE220A-G	P6KE220CA-G	185.0	209.00	231.00	1.0	100	328.0	1.83	5	P6KE220A	P6KE220CA
P6KE250-G	P6KE250C-G	202.0	225.00	275.00	1.0	100	360.0	1.67	5	P6KE250	P6KE250C
P6KE250A-G	P6KE250CA-G	214.0	237.50	262.50	1.0	100	344.0	1.74	5	P6KE250A	P6KE250CA
P6KE300-G	P6KE300C-G	243.0	270.00	330.00	1.0	100	430.0	1.40	5	P6KE300	P6KE300C
P6KE300A-G	P6KE300CA-G	256.0	285.00	315.00	1.0	100	414.0	1.45	5	P6KE300A	P6KE300CA
P6KE350-G	P6KE350C-G	284.2	315.00	385.00	1.0	100	504.0	1.19	5	P6KE350	P6KE350C
P6KE350A-G	P6KE350CA-G	299.3	332.50	367.50	1.0	100	482.0	1.24	5	P6KE350A	P6KE350CA
P6KE380-G	P6KE380C-G	208.6	342.00	418.00	1.0	100	547.2	1.10	5	P6KE380	P6KE380C
P6KE380A-G	P6KE380CA-G	324.9	361.00	399.00	1.0	100	524.4	1.14	5	P6KE380A	P6KE380CA
P6KE400-G	P6KE400C-G	324.8	360.00	440.00	1.0	100	574.0	1.05	5	P6KE400	P6KE400C
P6KE400A-G	P6KE400CA-G	342.0	380.00	420.00	1.0	100	548.0	1.09	5	P6KE400A	P6KE400CA
P6KE440-G	P6KE440C-G	357.3	396.00	484.00	1.0	100	633.6	0.95	5	P6KE440	P6KE440C
P6KE440A-G	P6KE440CA-G	376.2	418.00	462.00	1.0	100	607.2	0.99	5	P6KE440A	P6KE440CA

600W Transient Voltage Suppressor



RATING AND CHARACTERISTIC (P6KE-G Series)

Part No.		Absolute Maximum Rating (Ta=25 °C)					Electrical Characteristics (Ta=25 °C)			Marking Code.	
Uni	Bi	V _{RWM}	V _{BR} Min.	V _{BR} Max.	I _T	I _{FSM}	Max. Vc @I _{PPM}		Max. I _R @V _{RWM}	Uni	Bi
		(V)	(V)	(V)	(mA)	(A)@8.3mS	(V)	I _{PPM} (A)	uA		
P6KE500-G	P6KE500C-G	406.0	450.00	550.00	1.0	100	720.0	0.83	5	P6KE500	P6KE500C
P6KE500A-G	P6KE500CA-G	427.5	475.00	525.00	1.0	100	690.0	0.87	5	P6KE500A	P6KE500CA
P6KE520-G	P6KE520C-G	422.2	468.00	572.00	1.0	100	748.8	0.80	5	P6KE520	P6KE520C
P6KE520A-G	P6KE520CA-G	444.6	494.00	546.00	1.0	100	717.6	0.84	5	P6KE520A	P6KE520CA
P6KE550-G	P6KE550C-G	446.6	495.00	605.00	1.0	100	792.0	0.76	5	P6KE550	P6KE550C
P6KE550A-G	P6KE550CA-G	470.3	522.50	577.50	1.0	100	759.0	0.79	5	P6KE550A	P6KE550CA
P6KE600-G	P6KE600C-G	487.2	540.00	660.00	1.0	100	864.0	0.69	5	P6KE600	P6KE600C
P6KE600A-G	P6KE600CA-G	513.0	570.00	630.00	1.0	100	828.0	0.72	5	P6KE600A	P6KE600CA

RATING AND CHARACTERISTIC CURVES (P6KE-G Series)

Fig.1 - Pulse Derating Curve

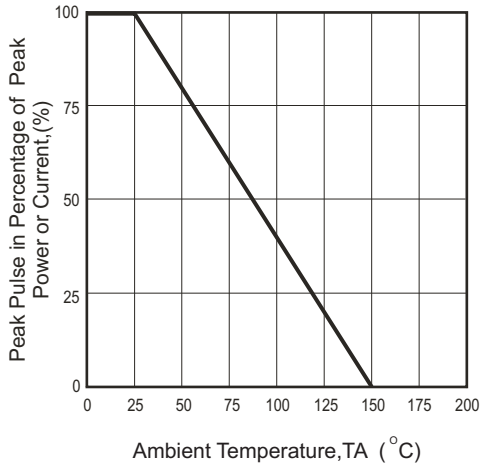

Fig.2 - Maximum Non-Repetitive Surge Current

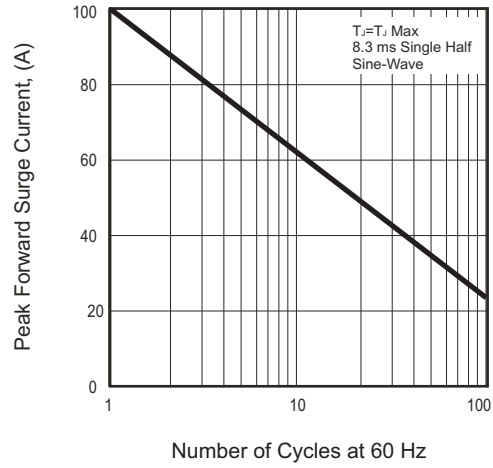

Fig.3 - Steady State Power Derating Curve

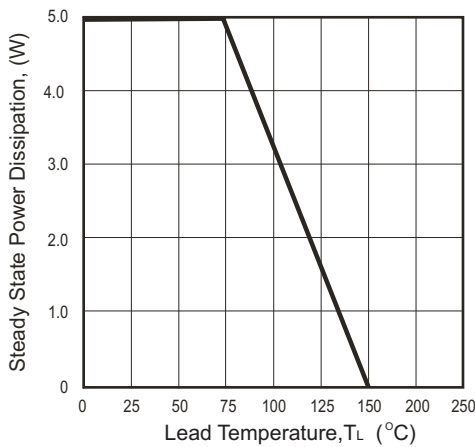

Fig.4 - Peak Pulse Power Rating Curve

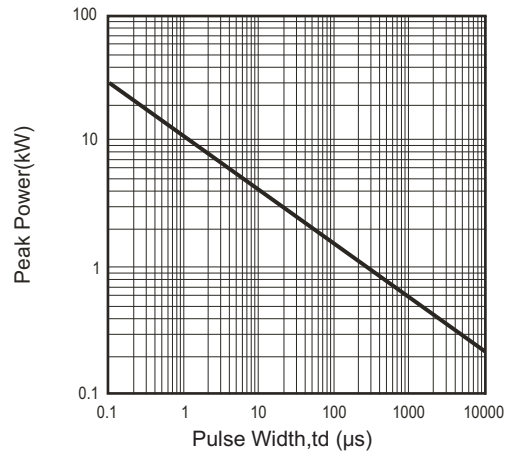

Fig.5 - Pulse Waveform

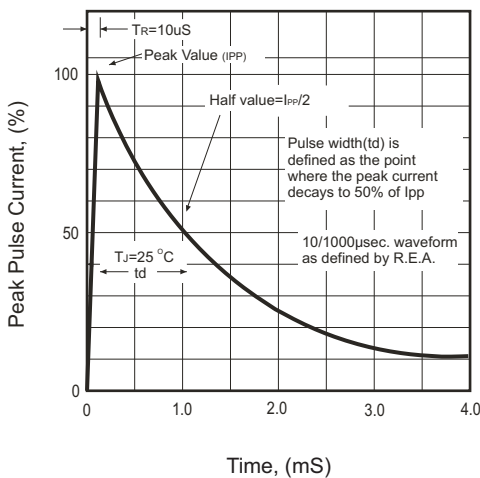
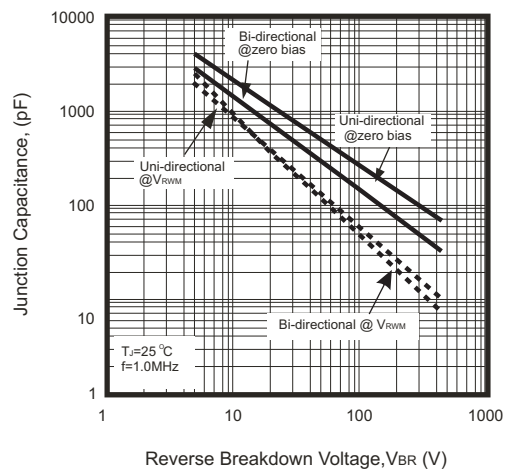
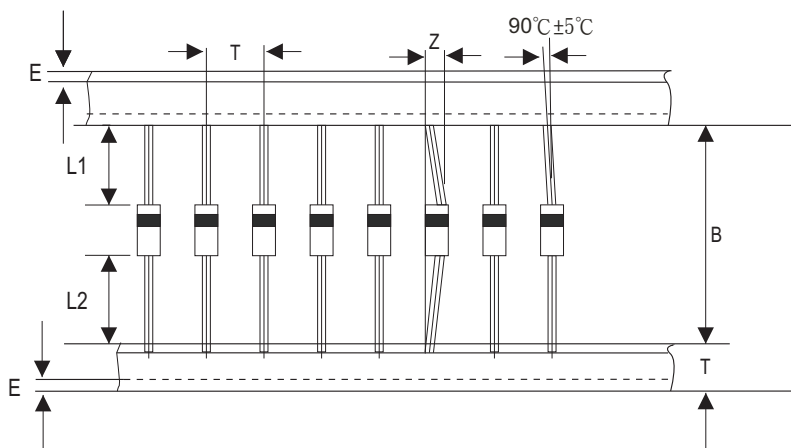

Fig.6 - Typical Junction Capacitance



Taping Specification For Axial Lead Diodes



DO-15	SYMBOL	A	B	Z	T	E	L1-L2
	(mm)	5.00 ± 0.5	52.0 ± 0.5	1.2 (max)	6.0 ± 0.4	3 (max)	1.0 (max)
	(inch)	0.197 ± 0.020	2.047 ± 0.020	0.047 (max)	0.236 ± 0.016	0.118 (max)	0.039 (max)

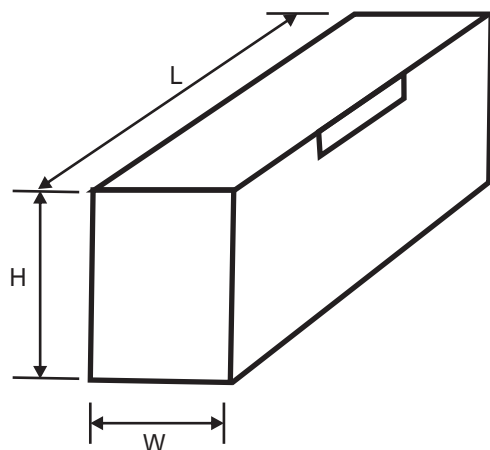

Standard Packaging

Case Type	BOX			
	Inner BOX Dimension (L*W*H)	Inner BOX (K)	Box / Carton (EA)	CARTON (K)
DO-15	252*80*117	2	10	20
DO-15	260*75*145	3	10	30