



	PD2401	Units
AC Operating Voltage	120	V_{RMS}
Load Current	1	A
On-State Voltage Drop	1.2	V_{RMS} ($A_T I_L = 1A$)

Features

- Load Current up to 1A
- Blocking Voltage to 600V
- 5mA Sensitivity
- Zero-Crossing Detection
- DC Control, AC Output
- Optically Isolated
- TTL and CMOS Compatible
- Low EMI and RFI Generation
- High Noise Immunity
- VDE compatible
- Machine Insertable, Wave Solderable

Applications

- Programmable Control
- Process Control
- Power Control Panels
- Remote Switching
- Gas Pump Electronics
- Contractors
- Large Relays
- Solenoids
- Motors
- Heaters

Description

The PD2401 is an AC Solid State Switch using optical coupling with dual power SCR outputs to produce an alternative to optocoupler and Triac circuits. The PD2401 switches are robust enough to provide a blocking voltage of up to 500V and max surge current rating of 20A. In addition, tightly controlled zero cross circuitry ensures switching of AC loads without the generation of transients. The input and output circuits are optically coupled to provide 3750V of isolation and noise immunity between control and load circuits. As a result the PD2401 is well suited for industrial environments where electromagnetic interference would disrupt the operation of electromechanical relays.

Approvals

- UL recognized file #: E69938
- CSA certified file #: LR 43639-8

Ordering Information

Part #	Description
PD2401	16 Pin DIP (25/Tube)

Pin Configuration

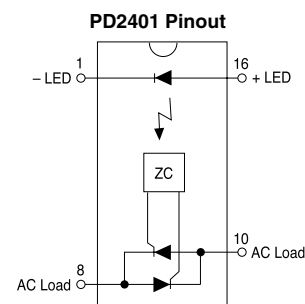

Absolute Maximum Ratings (@ 25° C)

Parameter	Min	Typ	Max	Units
Input Power Dissipation	-	-	150 ¹	mW
Input Control Current	-	-	50	mA
Peak (10ms)	-	-	1	A
Reverse Input Voltage	-	-	5	V
Total Package Dissipation PD	-	-	1600 ²	mW
Isolation Voltage Input to Output	3750	-	-	V _{RMS}
Operational Temperature	-40	-	+85	°C
Storage Temperature	-40	-	+125	°C
Soldering Temperature				
DIP Package	-	-	+260	°C
Surface Mount Package (10 Seconds Max.)	-	-	+220	°C

¹ Derate Linearly 1.33 mW/°C

² Derate Linearly 16.6 mW/°C

Absolute Maximum Ratings are stress ratings. Stresses in excess of these ratings can cause permanent damage to the device. Functional operation of the device at these or any other conditions beyond those indicated in the operational sections of this data sheet is not implied. Exposure of the device to the absolute maximum ratings for an extended period may degrade the device and effect its reliability.

Electrical Characteristics

Parameters	Conditions	Symbol	Min	Typ	Max	Units
Output Characteristics @ 25°C						
Peak Blocking Voltage	-	V _{DRM}	-	-	500	V
Load Current (Continuous)	V _L =120-240VAC	I _L	0.005	-	1	A
Off State Leakage Current	V _{DRM}	I _{LEAK}	-	-	1	mA
On-State Voltage Drop	I _L =1A		-	-	1.2	V _{RMS}
Critical Rate of Rise	dv/dt		1000	1200	-	V/μS
Switching Speeds						
Turn-on	I _F =5 mA	T _{ON}	-	-	0.5	Cycles
Turn-off	I _F =5 mA	T _{OFF}	-	-	0.5	Cycles
Zero-Cross Turn-On Voltage	1st half cycle		-	2	5	V
	Sub. half cycle		-	-	1	V
Operating Frequency ¹	-		20	-	500	Hz
Load Power Factor for Guaranteed Turn-On ²	-	PF	0.25	-	-	-
Capacitance Input to Output			-	-	-	pF
Input Characteristics @ 25°C						
Input Control Current						
For Normal Environment	-	I _F	5	-	50	mA
For High Noise Environment	-	I _F	10	-	100	mA
Input Voltage Drop	I _F =5mA	V _F	0.9	1.2	1.4	V
Input Drop-out Voltage	-		0.8	-	-	V
Reverse Input Current	V _R =5V	I _R	-	-	10	uA
Common Characteristics @ 25°C						
Input to Output Capacitance	-	C _{I/O}	-	-	3	V _{RMS}
Input to Output Isolation	-	V _{I/O}	3750	-	-	V _{RMS}

¹ Zero cross 1st 1/2 cycle @ <100Hz

² Snubber circuits may be required at low power factors.

PERFORMANCE DATA*

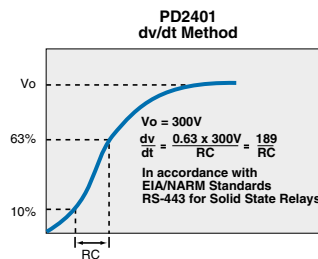
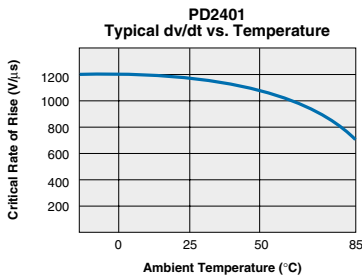
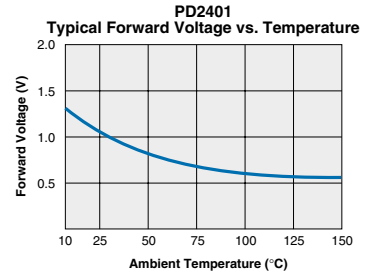
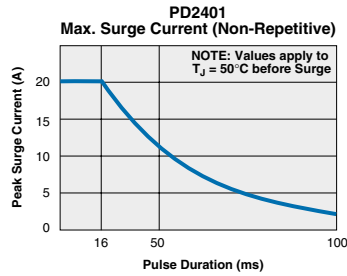
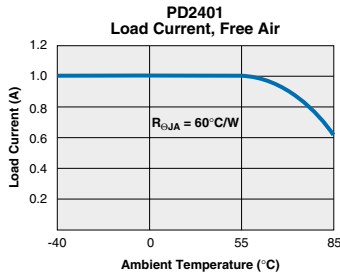

Mechanical Dimensions

16 Pin DIP

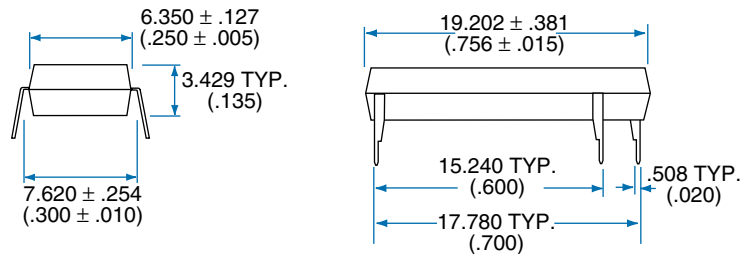

The Performance data shown in the graphs above is typical of device performance. For guaranteed parameters not indicated in the written specifications, please contact our application department.

CLARE LOCATIONS

Clare Headquarters
78 Cherry Hill Drive
Beverly, MA 01915
Tel: 1-978-524-6700
Fax: 1-978-524-4900
Toll Free: 1-800-27-CLARE

Clare Micronix Division
145 Columbia
Aliso Viejo, CA 92656-1490
Tel: 1-949-831-4622
Fax: 1-949-831-4628

SALES OFFICES

AMERICAS

Americas Headquarters

Clare
78 Cherry Hill Drive
Beverly, MA 01915
Tel: 1-978-524-6700
Fax: 1-978-524-4900
Toll Free: 1-800-27-CLARE

Eastern Region

Clare
P.O. Box 856
Mahwah, NJ 07430
Tel: 1-201-236-0101
Fax: 1-201-236-8685
Toll Free: 1-800-27-CLARE

Central Region

Clare Canada Ltd.
3425 Harvester Road, Suite 202
Burlington, Ontario L7N 3N1
Tel: 1-905-333-9066
Fax: 1-905-333-1824

Western Region

Clare
1852 West 11th Street, #348
Tracy, CA 95376
Tel: 1-209-832-4367
Fax: 1-209-832-4732
Toll Free: 1-800-27-CLARE

Canada

Clare Canada Ltd.
3425 Harvester Road, Suite 202
Burlington, Ontario L7N 3N1
Tel: 1-905-333-9066
Fax: 1-905-333-1824

EUROPE

European Headquarters

CP Clare nv
Bampslaan 17
B-3500 Hasselt (Belgium)
Tel: 32-11-300868
Fax: 32-11-300890

France

Clare France Sales
Lead Rep
99 route de Versailles
91160 Champlan
France
Tel: 33 1 69 79 93 50
Fax: 33 1 69 79 93 59

Germany

Clare Germany Sales
ActiveComp Electronic GmbH
Mitterstrasse 12
85077 Manching
Germany
Tel: 49 8459 3214 10
Fax: 49 8459 3214 29

Italy

C.L.A.R.E.s.a.s.
Via C. Colombo 10/A
I-20066 Melzo (Milano)
Tel: 39-02-95737160
Fax: 39-02-95738829

Sweden

Clare Sales
Comptronic AB
Box 167
S-16329 Spånga
Tel: 46-862-10370
Fax: 46-862-10371

United Kingdom

Clare UK Sales
Marco Polo House
Cook Way
Bindon Road
Taunton
UK-Somerset TA2 6BG
Tel: 44-1-823 352541
Fax: 44-1-823 352797

ASIA/PACIFIC

Asian Headquarters

Clare
Room N1016, Chia-Hsin, Bldg II,
10F, No. 96, Sec. 2
Chung Shan North Road
Taipei, Taiwan R.O.C.
Tel: 886-2-2523-6368
Fax: 886-2-2523-6369

<http://www.clare.com>

Clare cannot assume responsibility for use of any circuitry other than circuitry entirely embodied in this Clare product. No circuit patent licenses nor indemnity are expressed or implied. Clare reserves the right to change the specification and circuitry, without notice at any time. The products described in this document are not intended for use in medical implantation or other direct life support applications where malfunction may result in direct physical harm, injury or death to a person.
