

Features

- Diffused Junction
- Fast Switching for High Efficiency
- High Current Capability and Low Forward Voltage Drop
- Surge Overload Rating to 300A Peak
- Low Reverse Leakage Current
- **Lead Free Finish, RoHS Compliant (Note 4)**

Mechanical Data

- Case: R-6
- Case Material: Molded Plastic. UL Flammability Classification Rating 94V-0
- Moisture Sensitivity: Level 1 per J-STD-020C
- Terminals: Finish - Bright Tin. Plated Leads Solderable per MIL-STD-202, Method 208
- Polarity: Cathode Band
- Ordering Information: See Last Page
- Marking: Type Number
- Weight: 2.1 grams (approximate)

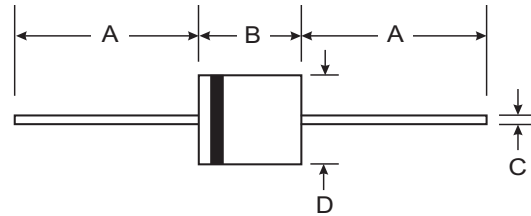

R-6		
Dim	Min	Max
A	25.40	—
B	8.60	9.10
C	1.20	1.30
D	8.60	9.10
All Dimensions in mm		

Maximum Ratings and Electrical Characteristics @ T_A = 25°C unless otherwise specified

Single phase, half wave, 60Hz, resistive or inductive load.
For capacitive load, derate current by 20%.

Characteristic	Symbol	PR 6001	PR 6002	PR 6003	PR 6004	PR 6005	Unit
Peak Repetitive Reverse Voltage	V _{RRM}	50	100	200	400	600	V
Working Peak Reverse Voltage	V _{RWM}						
DC Blocking Voltage	V _R						
RMS Reverse Voltage	V _{R(RMS)}	35	70	140	280	420	V
Average Rectified Output Current (Note 1)	I _O	6.0					A
		@ T _A = 60°C					
Non-Repetitive Peak Forward Surge Current	I _{FSM}	300					A
		8.3ms Single half sine-wave Superimposed on Rated Load (JEDEC Method)					
Forward Voltage	V _{FM}	1.2					V
		@ I _F = 6.0A					
Peak Reverse Current	I _{RM}	10					μA
		@ T _A = 25°C					
		@ T _A = 125°C					
Reverse Recovery Time (Note 3)	t _{rr}	150				250	ns
Typical Junction Capacitance (Note 2)	C _j	140				70	pF
Typical Thermal Resistance Junction to Ambient	R _{θJA}	32					K/W
Operating and Storage Temperature Range	T _j , T _{STG}	-65 to +150					°C

- Notes:
1. Valid provided that leads are maintained at ambient temperature at a distance of 9.5mm from the case.
 2. Measured at 1.0MHz and applied reverse voltage of 4.0 V DC.
 3. Measured with I_F = 0.5A, I_R = 1.0A, I_{rr} = 0.25 A. See figure 5.
 4. RoHS revision 13.2.2003. Glass and High Temperature Solder Exemptions Applied, see EU Directive Annex Notes 5 and 7.

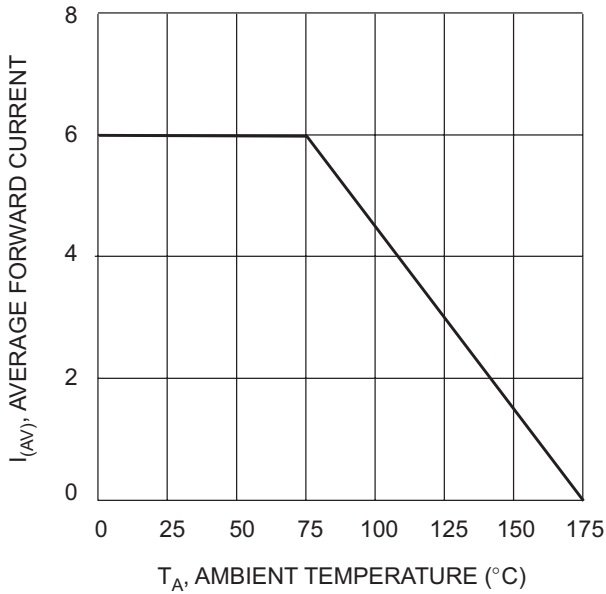

Fig. 1, Typical Forward Current Derating Curve

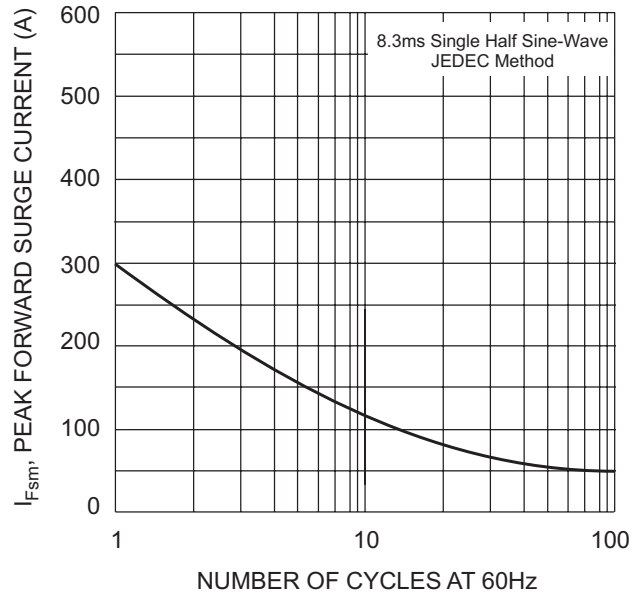

Fig. 2 Max Non-Repetitive Peak Surge Current

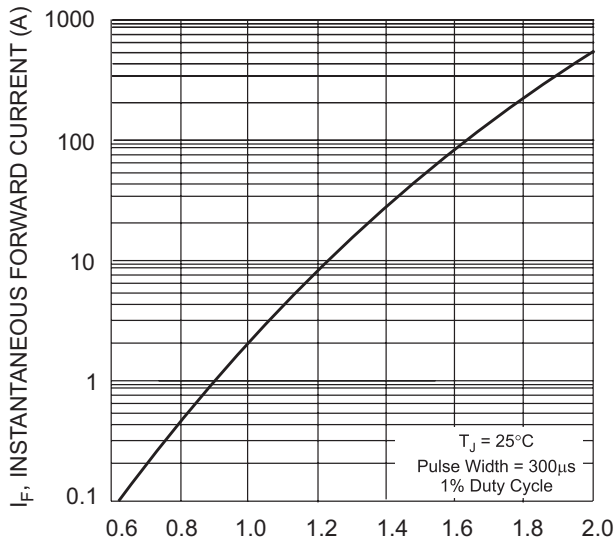

Fig. 3, Typical Instantaneous Forward Characteristics

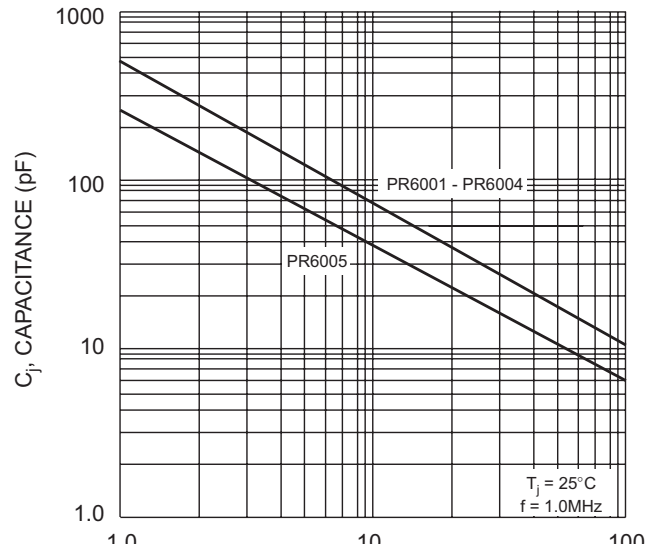
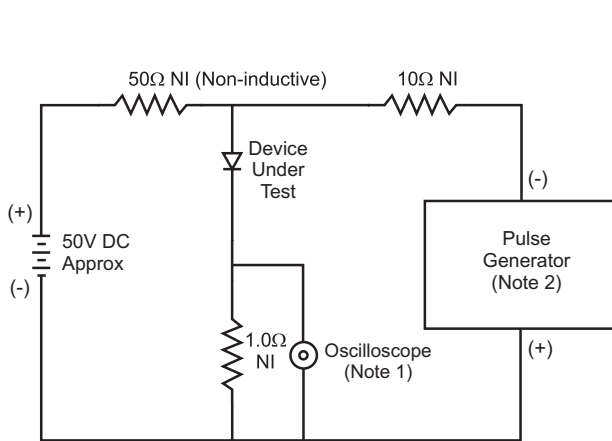
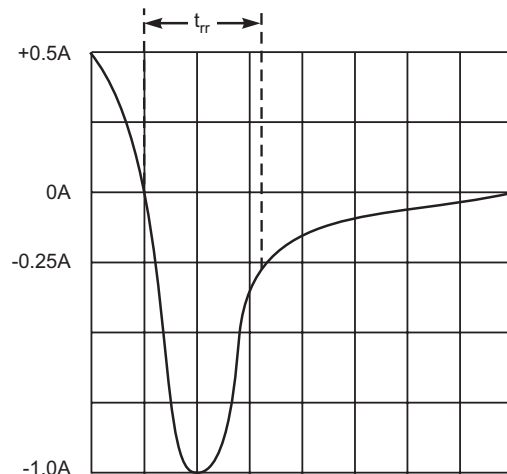

Fig. 4 Typical Junction Capacitance



- Notes:
1. Rise Time = 7.0ns max. Input Impedance = 1.0MΩ, 22pF.
 2. Rise Time = 10ns max. Input Impedance = 50Ω.



Set time base for 50/100 ns/cm

Fig. 5 Reverse Recovery Time Characteristic and Test Circuit

Ordering Information (Note 5)

Device	Packaging	Shipping
PR6001-T	R-6	500/Tape & Reel, 13-inch
PR6002-T	R-6	500/Tape & Reel, 13-inch
PR6003-T	R-6	500/Tape & Reel, 13-inch
PR6004-T	R-6	500/Tape & Reel, 13-inch
PR6005-T	R-6	500/Tape & Reel, 13-inch

Notes: 5. For packaging details, visit our website at <http://www.diodes.com/datasheets/ap02008.pdf>.