

### FEATURES

- **ISOLATION DISTANCE:**  
0.4 mm MIN.
- **AC INPUT RESPONSE**
- **HIGH ISOLATION VOLTAGE:**  
 $BV = 3.75 k V_{r.m.s.}$
- **SOP (SMALL OUT-LINE PACKAGE)**
- **HIGH SPEED SWITCHING:**  
 $t_r = 4 \mu s$  TYP,  $t_f = 5 \mu s$  TYP
- **AVAILABLE ON TAPE AND REEL**

### DESCRIPTION

The PS2765-1 is an optically coupled isolator containing GaAs light emitting diodes and an NPN silicon phototransistor. This package is mounted in a plastic SOP (Small Out-line Package) for high density applications and has a shield effect to cut off ambient light.

### APPLICATIONS

- HYBRID IC
- PROGRAMMABLE LOGIC CONTROLLERS
- POWER SUPPLY

### ELECTRICAL CHARACTERISTICS (TA = 25°C)

PART NUMBER			PS2765-1			
SYMBOLS	PARAMETERS	UNITS	MIN	TYP	MAX	
Diode	V <sub>F</sub>	Forward Voltage, I <sub>F</sub> = ±5 mA	V	1.1	1.4	
	C <sub>t</sub>	Terminal Capacitance, V = 0, f = 1 MHz	pF	30		
Transistor	I <sub>CEO</sub>	Collector to Emitter Dark Current, V <sub>CE</sub> = 40 V, I <sub>F</sub> = 0 mA	nA		100	
Coupled	CTR	Current Transfer Ratio (I <sub>c</sub> /I <sub>F</sub> ) <sup>1</sup> , I <sub>F</sub> = ±5 mA, V <sub>CE</sub> = 5 V	%	50	100	400
	V <sub>CE (sat)</sub>	Collector Saturation Voltage, I <sub>F</sub> = ±10 mA, I <sub>c</sub> = 2 mA	V			0.3
	R <sub>I-O</sub>	Isolation Resistance, V <sub>I-O</sub> = 1 kVDC	Ω	10 <sup>11</sup>		
	C <sub>I-O</sub>	Isolation Capacitance, V = 0, f = 1 MHz	pF		0.4	
	t <sub>r</sub>	Rise Time <sup>2</sup> , V <sub>CC</sub> = 5 V, I <sub>c</sub> = 2 mA, R <sub>L</sub> = 100 Ω	μs		4	
	t <sub>f</sub>	Fall Time <sup>2</sup> , V <sub>CC</sub> = 5 V, I <sub>c</sub> = 2 mA, R <sub>L</sub> = 100 Ω	μs		5	

Notes:

- CTR Rank  
N: 50 to 400%

2. Test Circuit for Switching Time

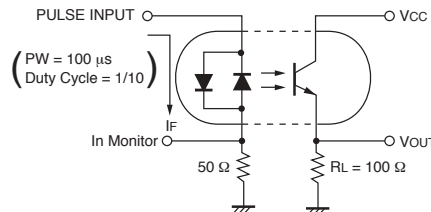

**ABSOLUTE MAXIMUM RATINGS<sup>1</sup>** (TA = 25°C)

SYMBOLS	PARAMETERS	UNITS	RATINGS
			PS2765-1
Diode			
IF	Forward Current (DC)	mA	±50
PD	Power Dissipation	mW	80
IF (PEAK)	Peak Forward Current <sup>2</sup>	A	±1.0
Transistor			
VCEO	Collector to Emitter Voltage	V	40
VECO	Emitter to Collector Voltage	V	5
IC	Collector Current	mA	40
PC	Power Dissipation	mW	150
ΔPC/°C	Power Dissipation Derating	mW/°C	1.5
Coupled			
BV	Isolation Voltage <sup>3</sup>	V <sub>r.m.s.</sub>	3750
TA	Operating Ambient Temp.	°C	-55 to +100
TSTG	Storage Temperature	°C	-55 to +150

Notes:

1. Operation in excess of any one of these parameters may result in permanent damage.
2. PW = 100 μs, duty cycle = 1%.
3. AC voltage for 1 minute at TA = 25 °C, RH = 60 % between input and output.

**TYPICAL PERFORMANCE CURVES** (TA = 25°C)

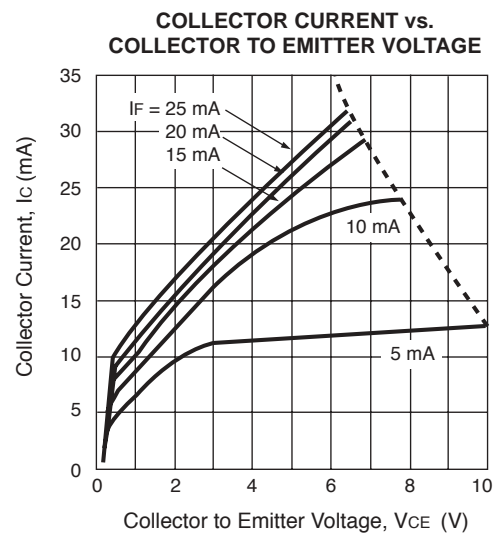
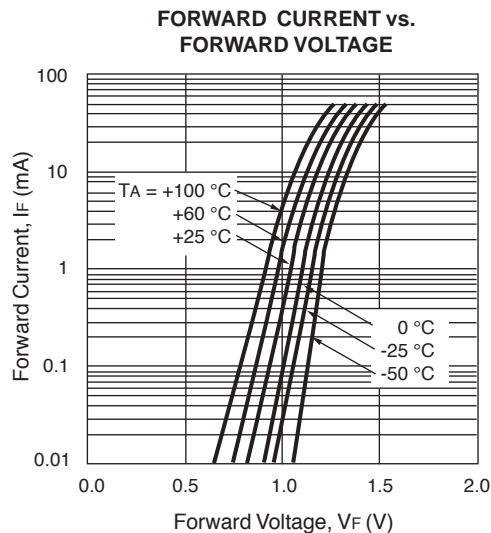
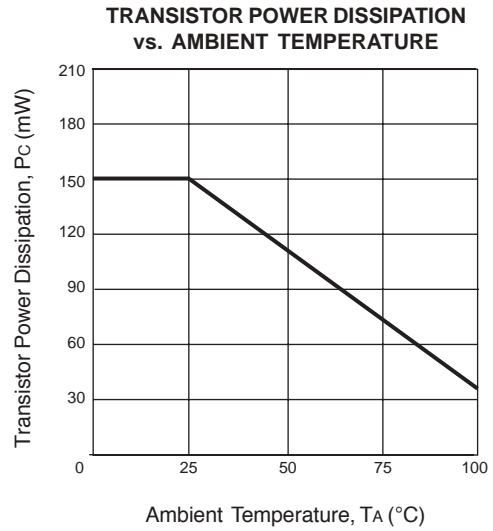
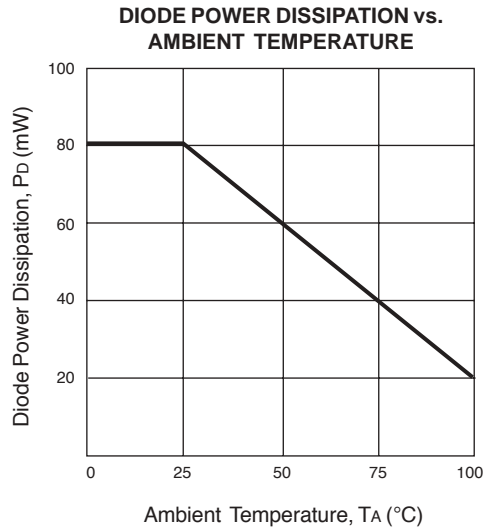

**ORDERING INFORMATION**

PART NUMBER	PACKAGE	PACKING STYLE
PS2765-1	4-pin SOP	Magazine case 100 pcs
PS2765-1-F3		Embossed Tape 3500 pcs/reel
PS2765-1-F4		

**TYPICAL PERFORMANCE CURVES** ( $T_A = 25^\circ\text{C}$ )

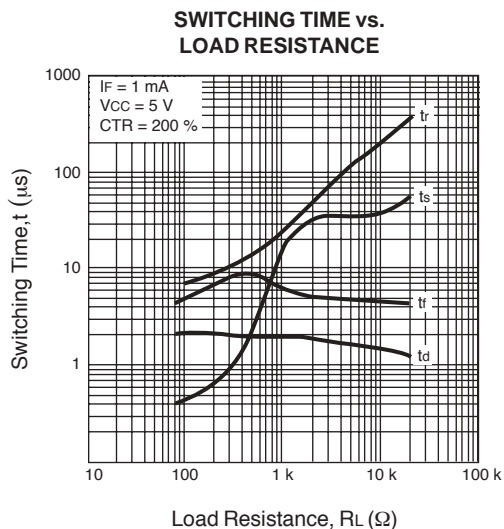
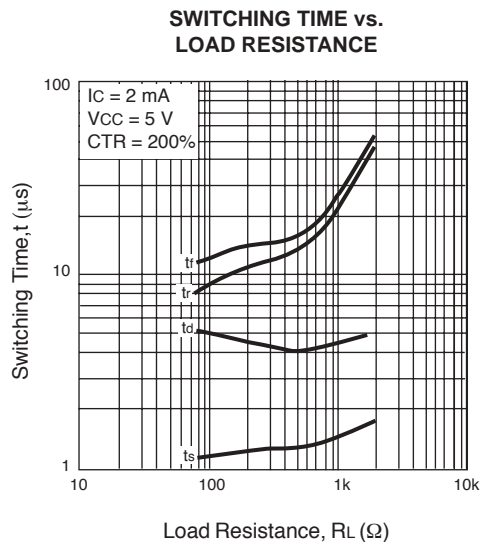
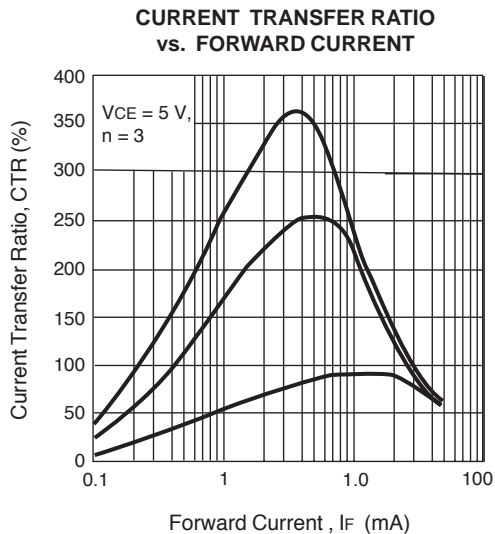
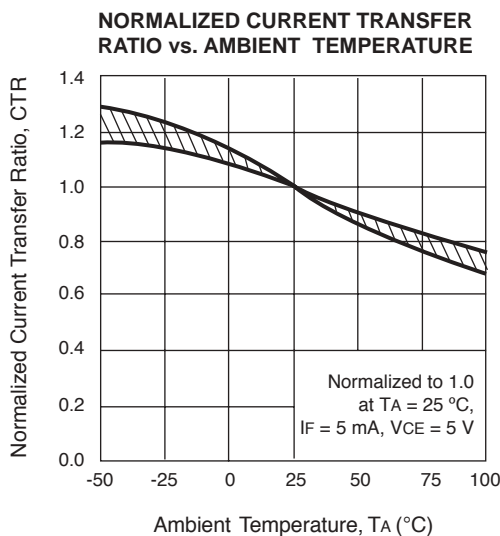
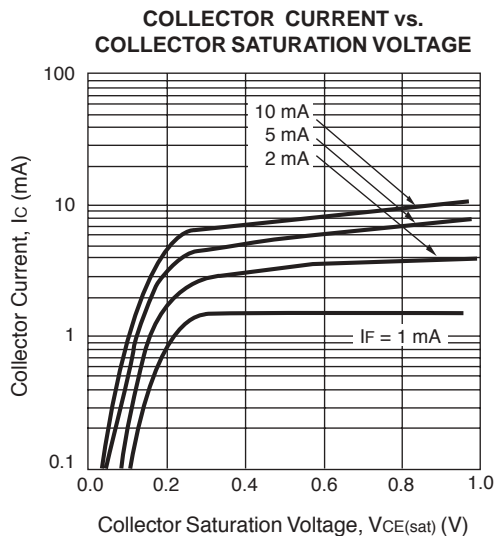
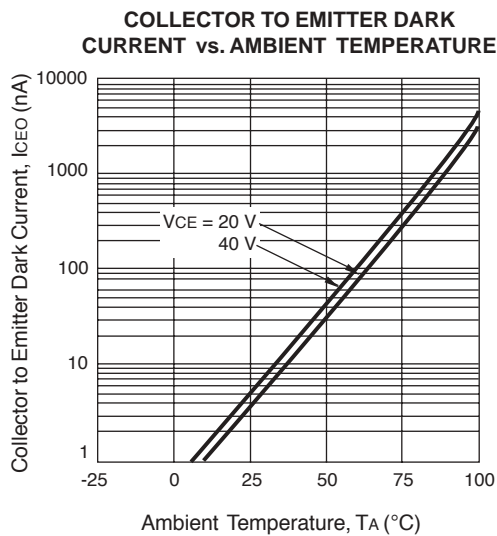

**TYPICAL PERFORMANCE CURVES** (TA = 25°C)

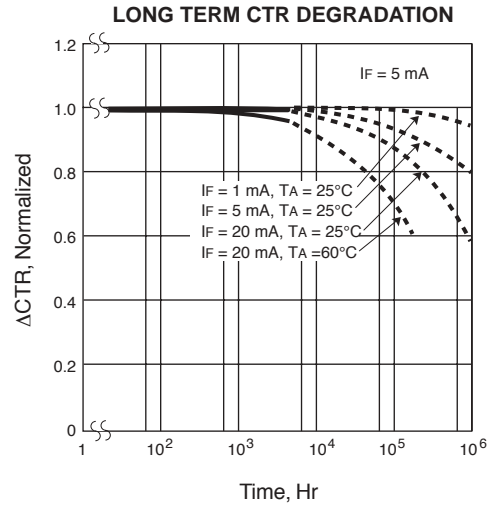
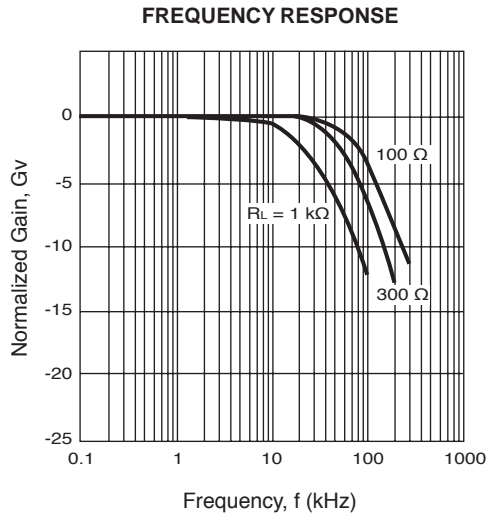

**OUTLINE DIMENSIONS** (Units in mm)

**PHOTOCOUPLER CONSTRUCTION**

PARAMETER	UNIT (MIN)
Air Distance	5 mm
Creepage Distance	5 mm
Isolation Distance	0.4 mm

PS2765-1

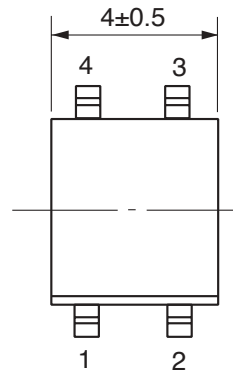

TOP VIEW

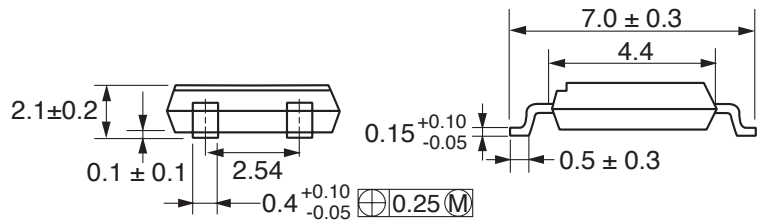
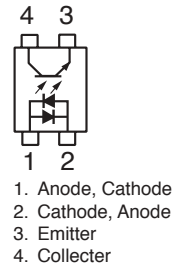

**TAPING SPECIFICATIONS** (Units in mm)

**OUTLINE AND DIMENSIONS (TAPE)**

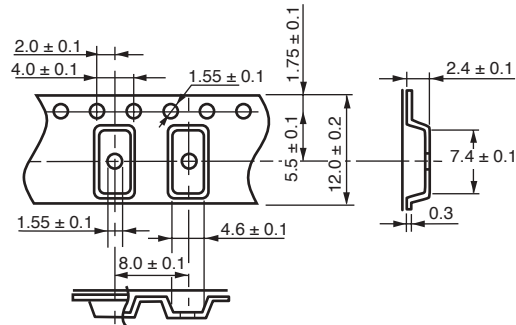

**TAPING DIRECTION**

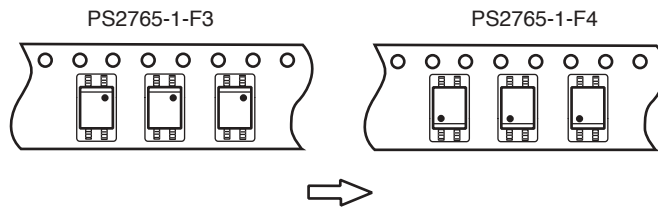

**OUTLINE AND DIMENSIONS (REEL)**

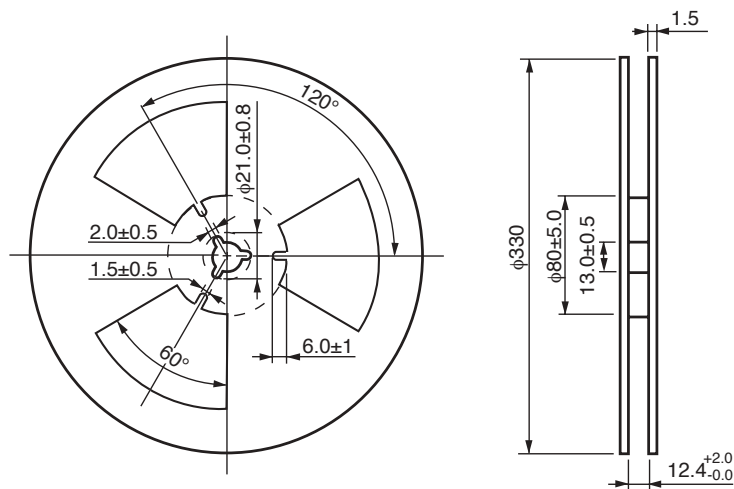

Packing: 3500 pcs/reel

### 1. Recommended Soldering Conditions

#### (1) Infrared reflow soldering

- Peak reflow temperature 235 °C (package surface temperature)
- Time of temperature higher than 210 °C 30 seconds or less
- Number of reflows Three
- Flux Rosin flux containing small amount of chlorine (The flux with a maximum chlorine content of 0.2 Wt % is recommended).

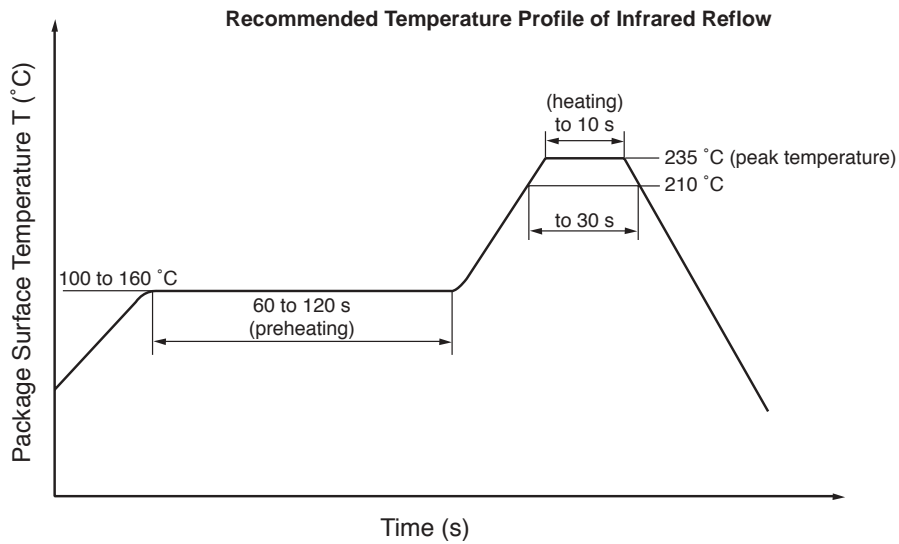

#### (2) Dip soldering

- Temperature 260 °C or below (molten solder temperature)
- Time 10 seconds or less
- Number of times One (allowed to be dipped in solder including plastic mold portion)
- Flux Rosin flux containing small amount of chlorine (The flux with a maximum chlorine content of 0.2 Wt % is recommended).

#### (3) Cautions

- Fluxes Avoid removing the residual flux with freon-based and chlorine-based cleaning solvent.

### 2. Cautions regarding noise

Be aware that when voltage is applied suddenly between the photocoupler's input and output or between corrector -emitters at startup, the output side may enter the on state, even if the voltage is within the absolute maximum ratings.