CMOS 2ch-LDOs for RF Unit

NO. EA-062-0606

OUTLINE

The R5321D Series are CMOS-based 2 channels voltage regulator ICs with high output voltage accuracy, extremely low supply current, low noise, low ON-resistance and high ripple rejection. The R5321D Series contain two voltage regulators. Each of these voltage regulators in the R5321D Series consists of a voltage reference unit, an error amplifier, resistors for setting output voltage, a current limit circuit and a chip enable circuit.

The chip enable function contributes to prolong battery life. Further, regulators in the R5321D Series are with low dropout voltage, excellent load transient response and line transient response, thus the R5321D Series are very suitable for the power supply for hand-held communication equipment.

The output voltage of each regulator is fixed with high accuracy by laser trim.

Since the package for these ICs is SON-8 package, high density mounting of the ICs on boards is possible.

FEATURES

- Low Supply Current Typ. 70 μ A (VR1, VR2)
- Low Standby Current Typ. 0.1 μ A (VR1, VR2)
- Low Dropout Voltage..... Typ. 0.23V (VR1) ($I_{OUT}=150\text{mA}, V_{OUT}=3.0\text{V}$)
Typ. 0.17V (VR2) ($I_{OUT}=150\text{mA}, V_{OUT}=3.0\text{V}$)
- Input Voltage Max.6.0V
- High Ripple Rejection Typ. 70dB ($f=1\text{kHz}$)
- High Output Voltage Accuracy $\pm 2.0\%$
- Excellent Load Transient Response and Line Transient Response
- Small Package SON-8

APPLICATIONS

- Power source for cellular phones such as GSM, CDMA and Personal Handy-phone System.
- Power source for electrical appliances such as cameras, VCRs, camcorders, etc.
- Power source for battery-powered equipment.

BLOCK DIAGRAMS

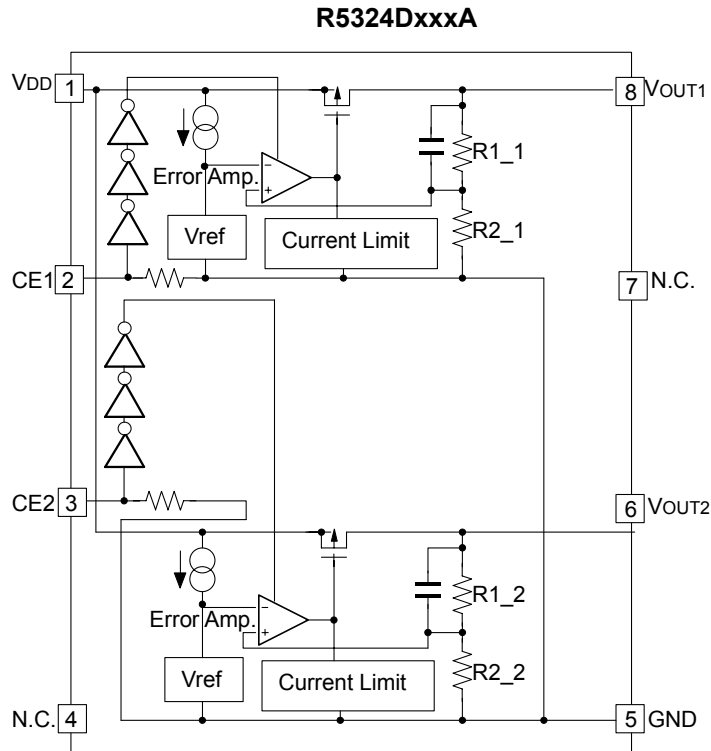

SELECTION GUIDE

The selection can be made with designating the part number as shown below:

R5321Dxxxx-xx-x ← Part Number
 ↑ ↑ ↑ ↑
 a b c d

Code	Contents
a	Serial Number for Voltage setting from 001
b	Alphabetical Code for Mask Versions A : Standard
c	Designation of Taping Type (TR)
d	Designation of Composition of pin plating. -F : Lead free plating

PIN CONFIGURATIONS

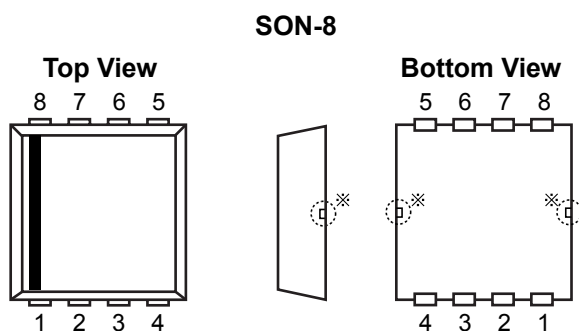

PIN DESCRIPTIONS

Pin No	Symbol	Pin Description
1	V _{DD}	Input Pin
2	CE1	Chip Enable Pin
3	CE2	Chip Enable Pin
4	N.C.	No Connection
5	GND	Ground Pin
6	V _{OUT2}	Output Pin
7	N.C.	No Connection
8	V _{OUT1}	Output Pin

* Tab in the  parts have GND level. (They are connected to the reverse side of this IC.)
Do not connect to other wires or land patterns.

ABSOLUTE MAXIMUM RATINGS

Symbol	Item	Rating	Unit
V _{IN}	Input Voltage	6.5	V
V _{CE}	Input Voltage (CE Pin)	-0.3~V _{IN} +0.3	V
V _{OUT}	Output Voltage	-0.3~V _{IN} +0.3	V
I _{OUT1}	Output Current (V _{OUT1})	200	mA
I _{OUT2}	Output Current (V _{OUT2})	200	mA
P _D	Power Dissipation	480	mW
T _{opt}	Operating Temperature Range	-40~85	°C
T _{stg}	Storage Temperature Range	-55~125	°C

*) For Power Dissipation, please refer to PACKAGE INFORMATION to be described.

ELECTRICAL CHARACTERISTICS

• R5321DxxxA

VR1

T_{opt}=25°C

Symbol	Item	Conditions	Min.	Typ.	Max.	Unit
V _{OUT}	Output Voltage	V _{IN} -V _{OUT} =1.0V 1mA ≤ I _{OUT} ≤ 50mA	×0.98		×1.02	V
I _{OUT}	Output Current	V _{IN} -V _{OUT} =1.0V	150			mA
ΔV _{OUT} /ΔI _{OUT}	Load Regulation	V _{IN} -V _{OUT} =1.0V 1mA ≤ I _{OUT} ≤ 80mA		12	40	mV
V _{DIF}	Dropout Voltage	Refer to Electrical Characteristic by Output Voltage (VR1)				
I _{SS}	Supply Current	V _{IN} -V _{OUT} =1.0V		70	120	μA
I _{standby}	Supply Current (Standby)	V _{IN} -V _{OUT} =1.0V, V _{CE} =GND		0.1	1.0	μA
ΔV _{OUT} /ΔV _{IN}	Line Regulation	V _{OUT} +0.5V ≤ V _{IN} ≤ 6.0V I _{OUT} =30mA		0.05	0.20	%/V
RR	Ripple Rejection	f=1kHz, sinusoidal Ripple 1.0Vp-p V _{IN} -V _{OUT} =1.0V, V _{OUT} ≥ 1.9V		70		dB
		1.5V ≤ V _{IN} ≤ 1.8V		60		
V _{IN}	Input Voltage		2.0		6.0	V
ΔV _{OUT} /ΔT _{opt}	Output Voltage Temperature Coefficient	I _{OUT} =50mA -40°C ≤ T _{opt} ≤ 85°C		±100		ppm/°C
I _{lim}	Short Current Limit	V _{OUT} =0V		50		mA
R _{PD}	CE Pull-down Resistance		2.5	5.0	10.0	MΩ
V _{CEH}	CE Input Voltage "H"		1.5		V _{IN}	V
V _{CEL}	CE Input Voltage "L"		0.00		0.25	V
en	Output Noise	BW=10Hz~100kHz		60		μVrms

• ELECTRICAL CHARACTERISTICS by OUTPUT VOLTAGE (VR1)

T_{opt} = 25°C

Output Voltage V _{OUT} (V)	Dropout Voltage V _{DIF} (V)		
	Condition	Typ.	Max.
V _{OUT} =1.5	I _{OUT} =150mA	0.55	0.65
V _{OUT} =1.6		0.45	0.60
1.7 ≤ V _{OUT} ≤ 1.9		0.35	0.60
2.0 ≤ V _{OUT} ≤ 2.4		0.35	0.48
2.5 ≤ V _{OUT} ≤ 2.7		0.25	0.35
2.8 ≤ V _{OUT} ≤ 3.3		0.23	0.33
3.4 ≤ V _{OUT} ≤ 5.0		0.21	0.27

VR2

T_{opt}=25°C

Symbol	Item	Conditions	Min.	Typ.	Max.	Unit
V _{OUT}	Output Voltage	V _{IN} -V _{OUT} =1.0V 1mA ≤ I _{OUT} ≤ 50mA	×0.98		×1.02	V
I _{OUT}	Output Current	V _{IN} -V _{OUT} =1.0V	150			mA
ΔV _{OUT} /ΔI _{OUT}	Load Regulation	V _{IN} -V _{OUT} =1.0V 1mA ≤ I _{OUT} ≤ 80mA		12	40	mV
V _{DIF}	Dropout Voltage	Refer to Electrical Characteristic by Output Voltage (VR2)				
I _{SS}	Supply Current	V _{IN} -V _{OUT} =1.0V		70	120	μA
I _{standby}	Supply Current (Standby)	V _{IN} -V _{OUT} =1.0V, V _{CE} =GND		0.1	1.0	μA
ΔV _{OUT} /ΔV _{IN}	Line Regulation	V _{OUT} +0.5V ≤ V _{IN} ≤ 6.0V I _{OUT} =30mA		0.05	0.20	%/V
RR	Ripple Rejection	f=1kHz, sinusoidal Ripple 1.0Vp-p V _{IN} -V _{OUT} =1.0V, V _{OUT} ≥ 1.9V		70		dB
		1.5V ≤ V _{IN} ≤ 1.8V		60		
V _{IN}	Input Voltage		2.0		6.0	V
ΔV _{OUT} /ΔT _{opt}	Output Voltage Temperature Coefficient	I _{OUT} =50mA -40°C ≤ T _{opt} ≤ 85°C		±100		ppm/°C
I _{lim}	Short Current Limit	V _{OUT} =0V		50		mA
R _{PD}	CE Pull-down Resistance		2.5	5.0	10.0	MΩ
V _{CEH}	CE Input Voltage "H"		1.5		V _{IN}	V
V _{CEL}	CE Input Voltage "L"		0.00		0.25	V
en	Output Noise	BW=10Hz~100kHz		60		μVrms

• ELECTRICAL CHARACTERISTICS by OUTPUT VOLTAGE (VR2)

T_{opt} = 25°C

Output Voltage V _{OUT} (V)	Dropout Voltage V _{DIF} (V)		
	Condition	Typ.	Max.
V _{OUT} =1.5	I _{OUT} =150mA	0.50	0.65
V _{OUT} =1.6		0.40	0.55
1.7 ≤ V _{OUT} ≤ 1.9		0.30	0.45
2.0 ≤ V _{OUT} ≤ 2.4		0.23	0.35
2.5 ≤ V _{OUT} ≤ 2.7		0.19	0.29
2.8 ≤ V _{OUT} ≤ 3.3		0.17	0.26
3.4 ≤ V _{OUT} ≤ 5.0		0.15	0.21

OPERATION

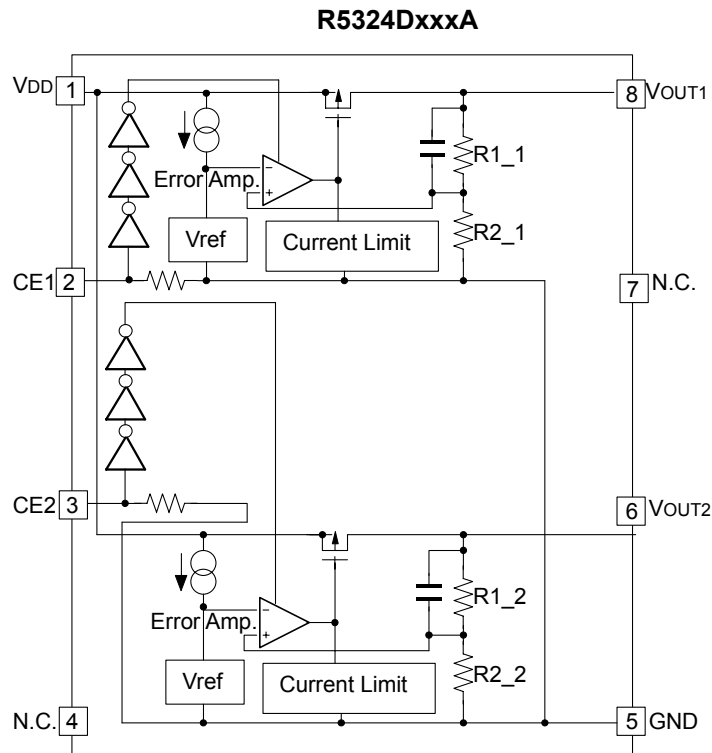

Fluctuation of each regulator's output voltage, or V_{OUT1} , V_{OUT2} is detected individually and put back to an error amplifier through feedback resistors, or $R1_1$, $R2_1$, $R1_2$, $R2_2$ and compared with a reference voltage and compensated for the result and make a constant voltage.

In each regulator, short protection is made by a current limit circuit and stand-by mode is available by a chip enable circuit.

TEST CIRCUIT

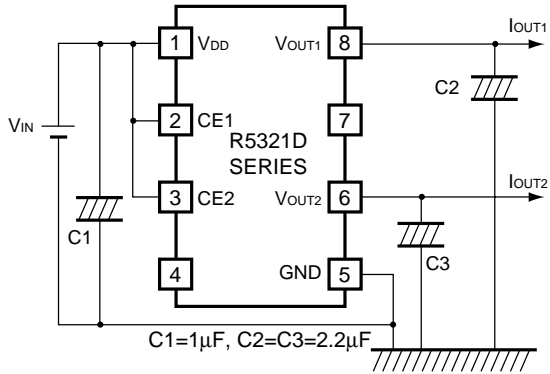

Basic Test Circuit

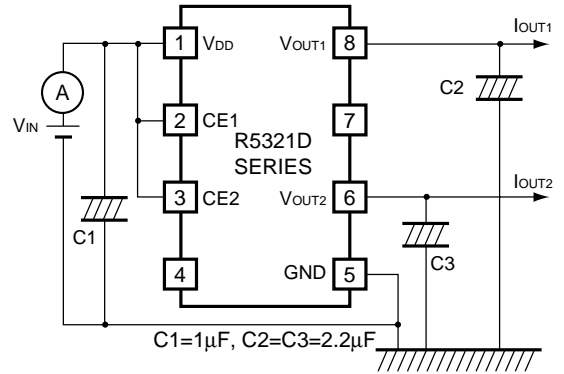

Test Circuit for Supply Current

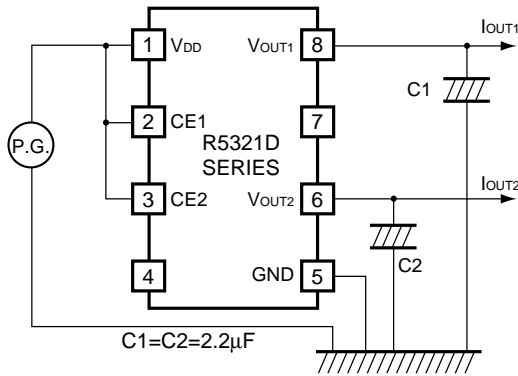

Test Circuit for Line Transient Response

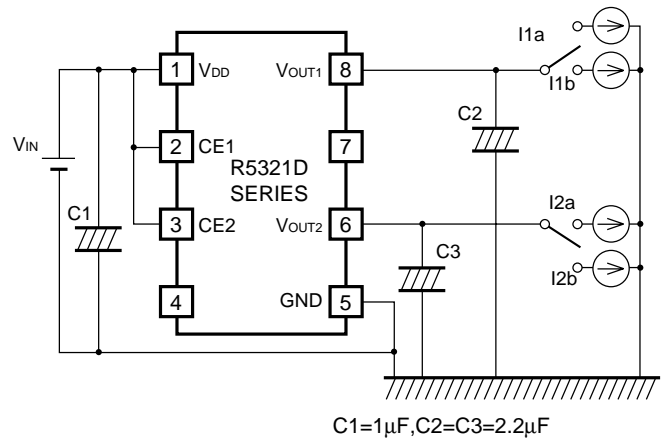

Test Circuit for Load Transient Response

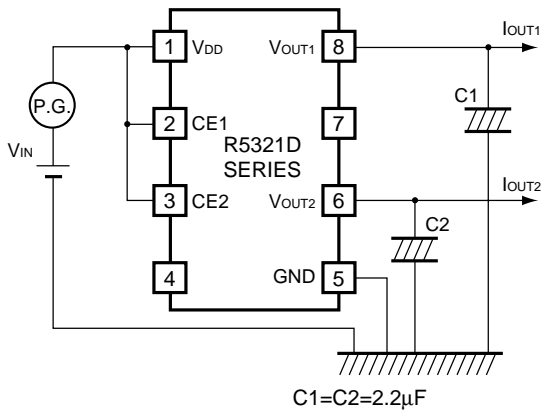

Test Circuit for Ripple Rejection

TYPICAL CHARACTERISTICS

1) Output Voltage vs. Output Current

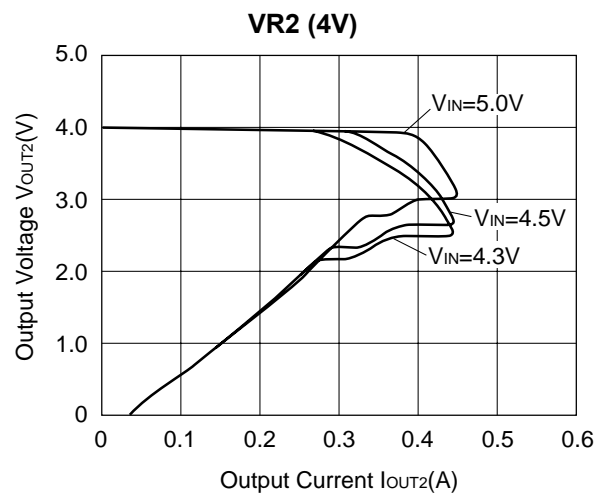
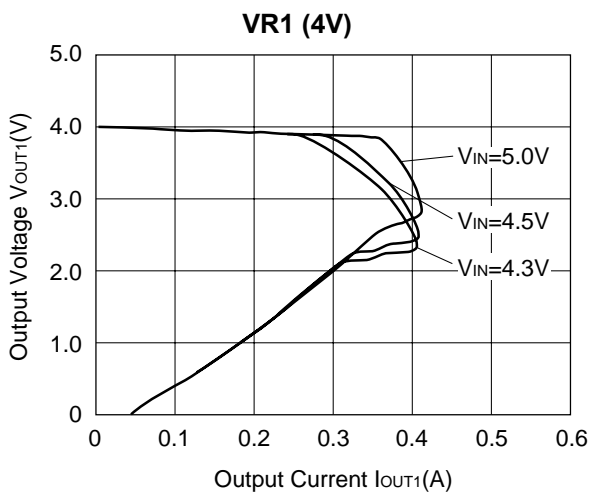
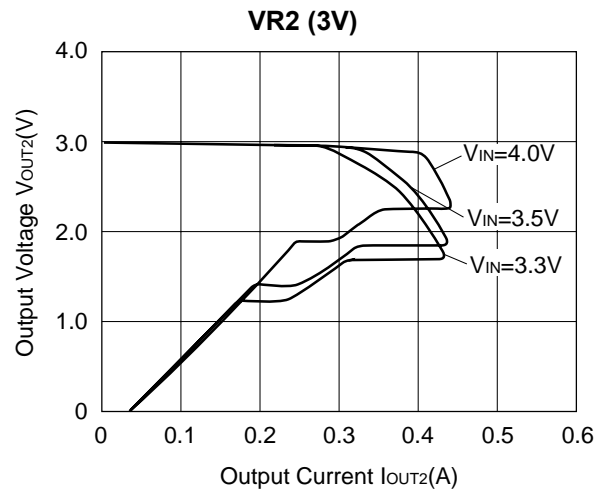
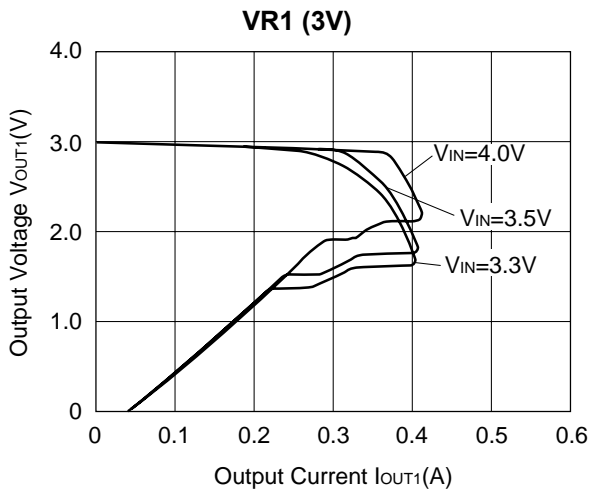
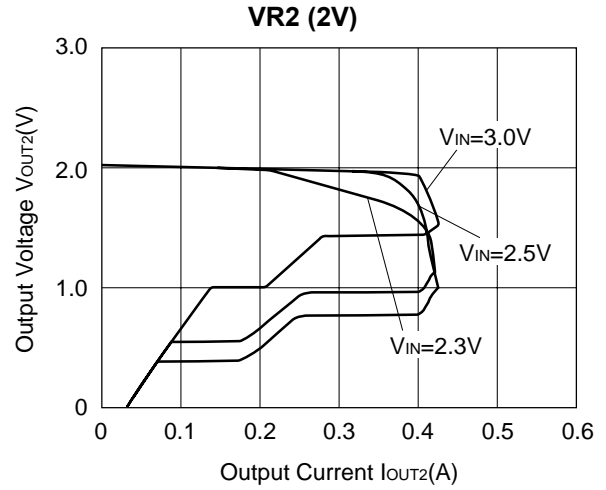
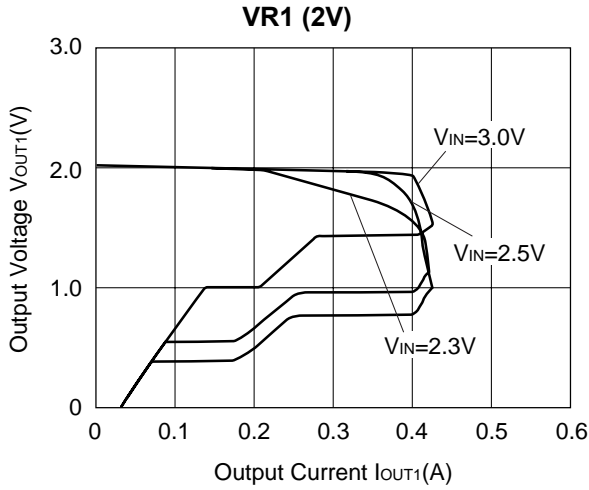

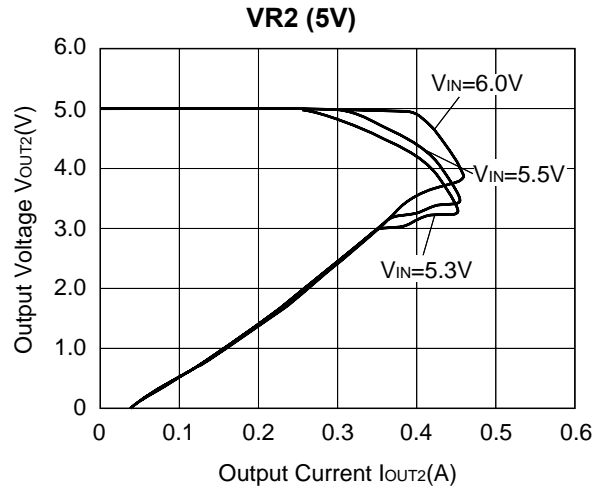
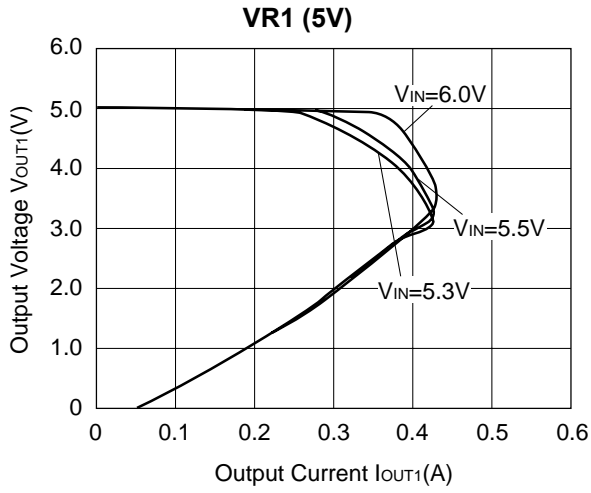

2) Output Voltage vs. Input Voltage

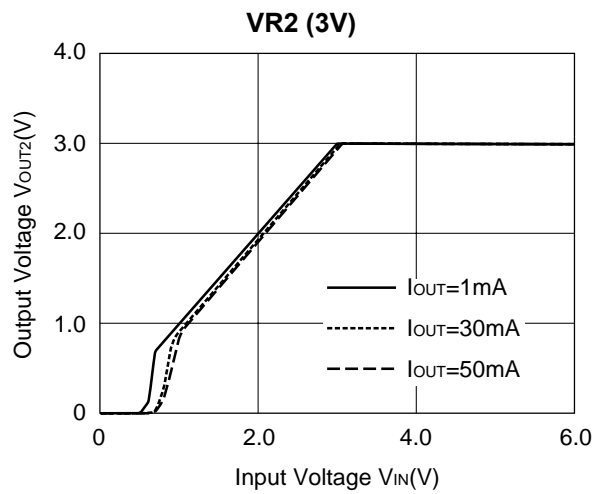
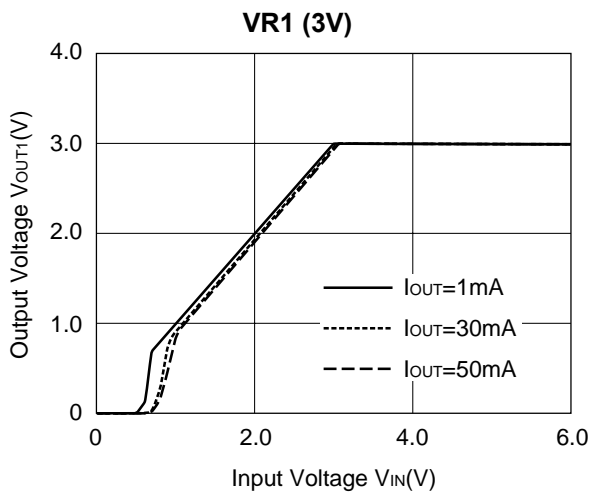
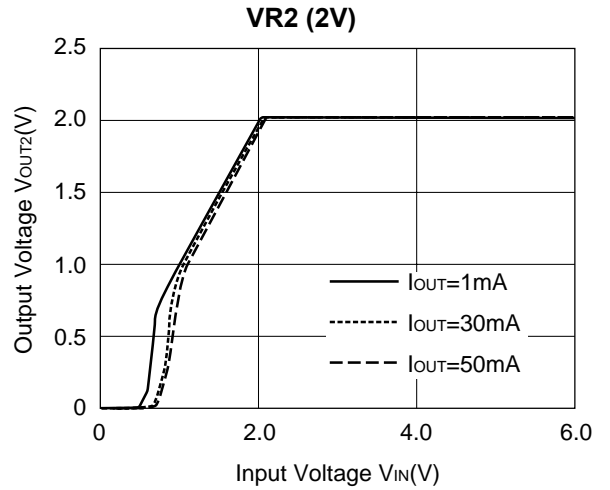
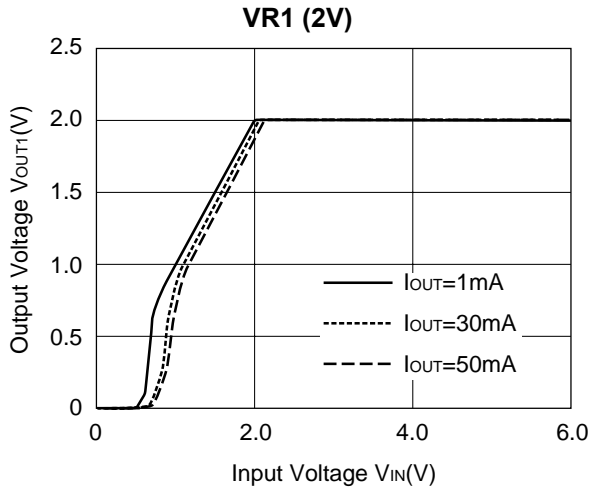

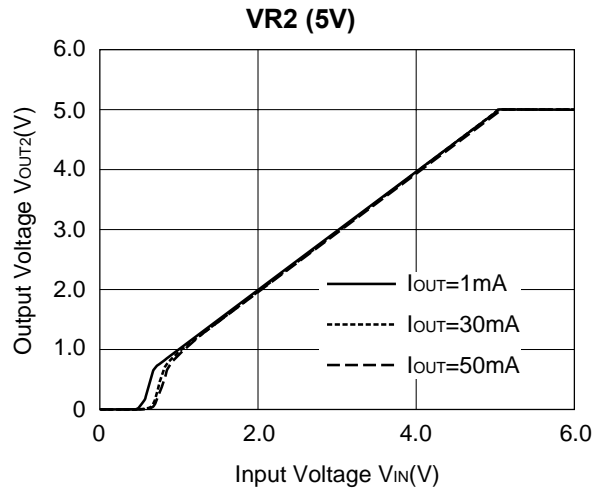
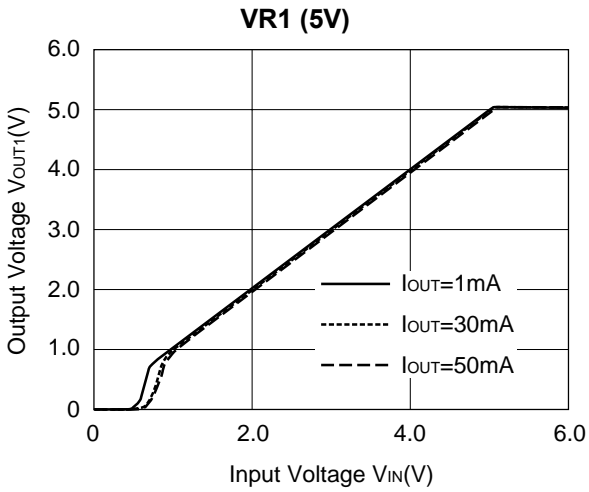
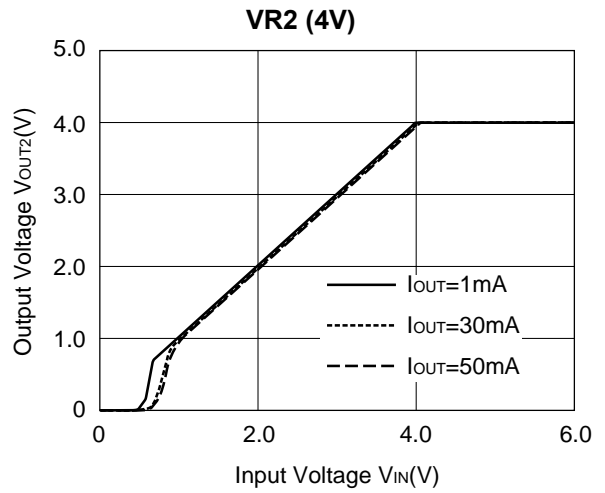
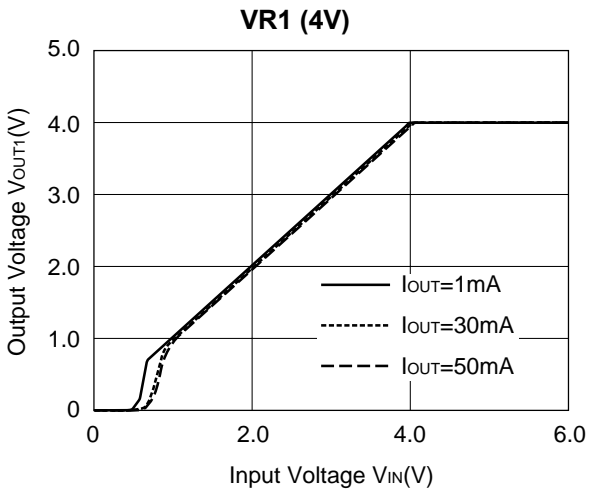

3) Ripple Rejection vs. Input Voltage (DC bias)

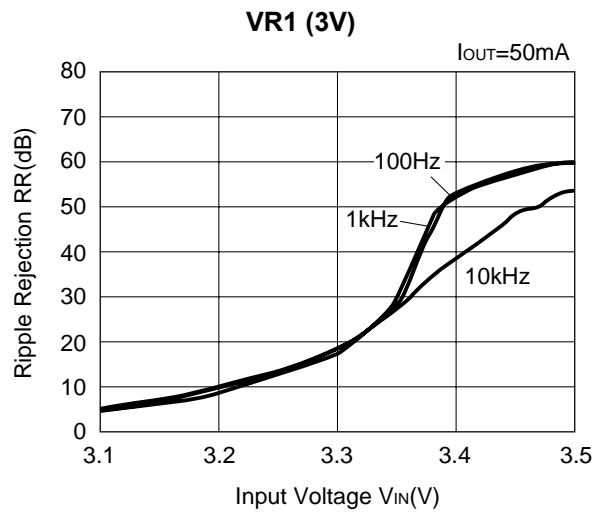
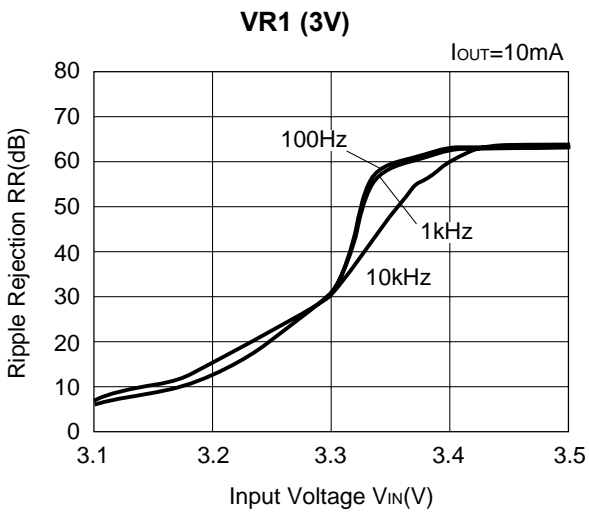

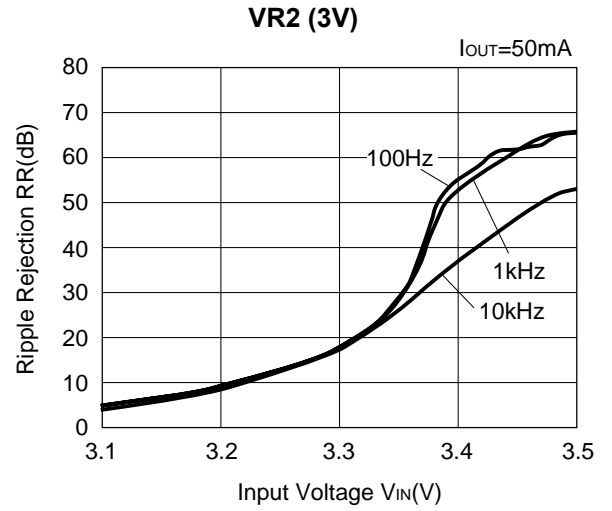
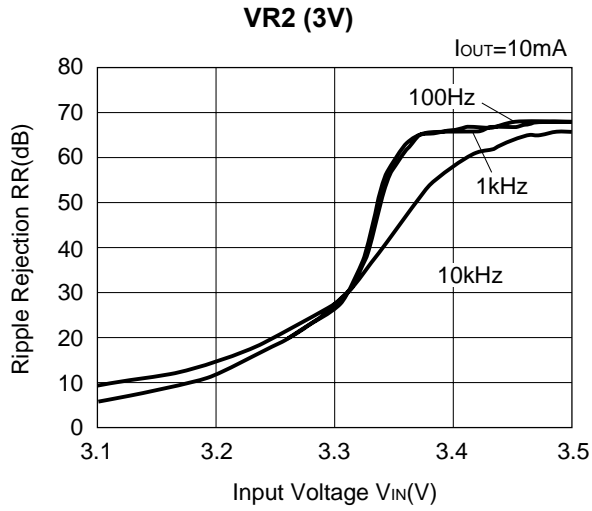

4) Output Voltage vs. Temperature

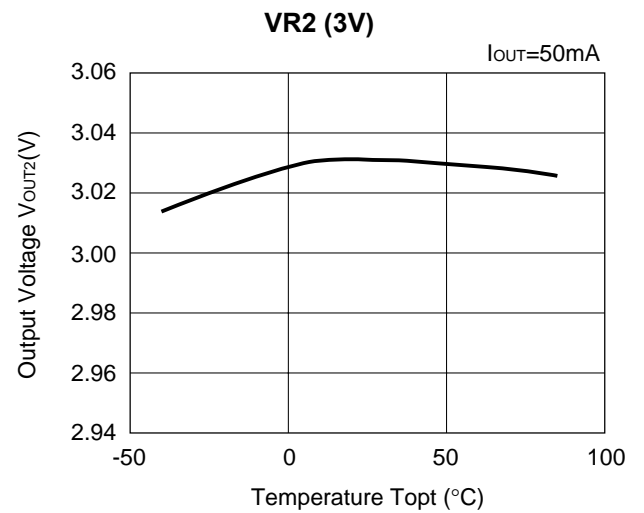
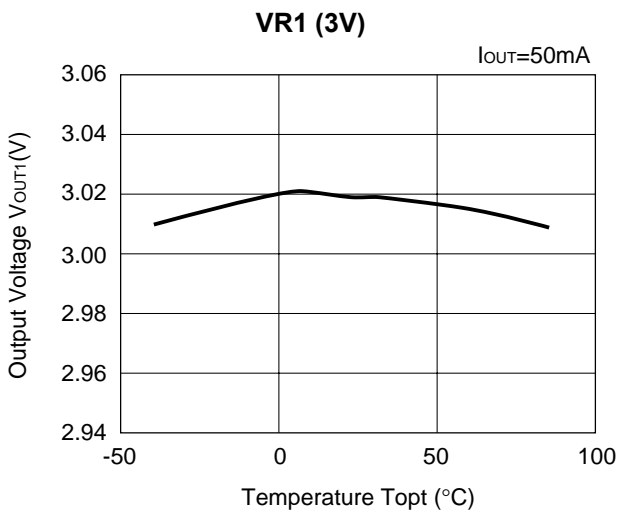
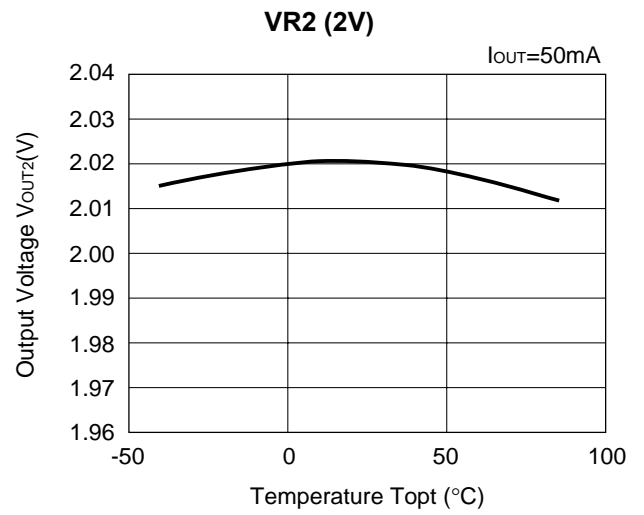
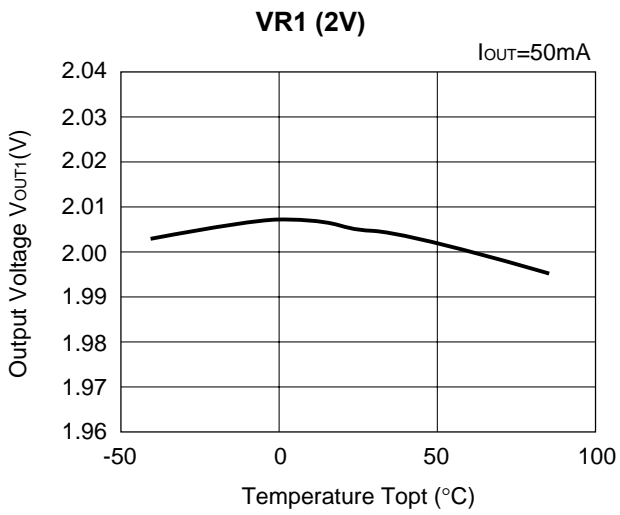

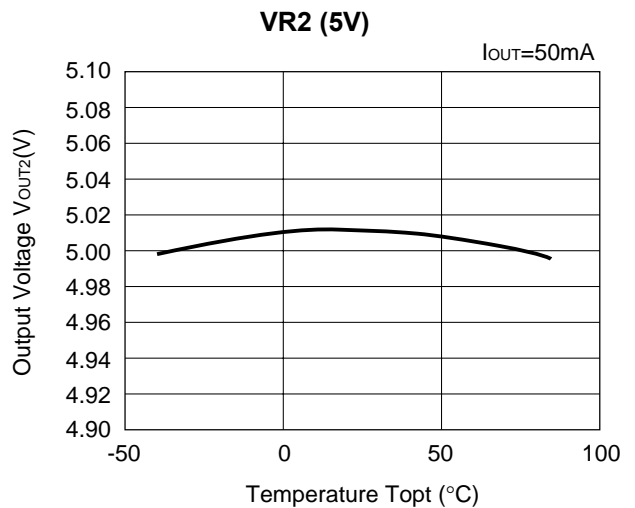
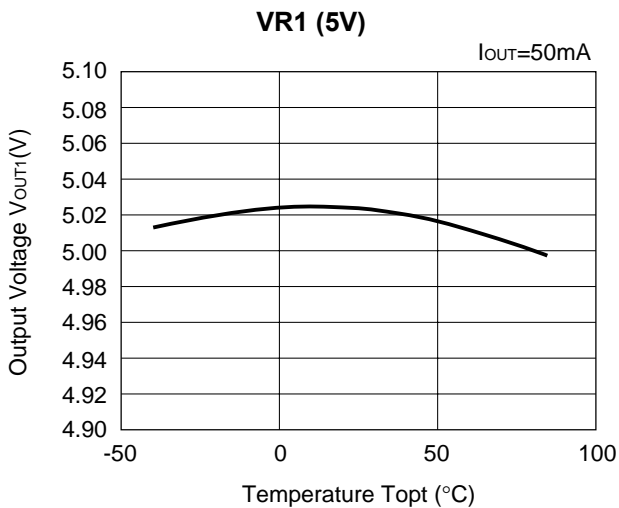
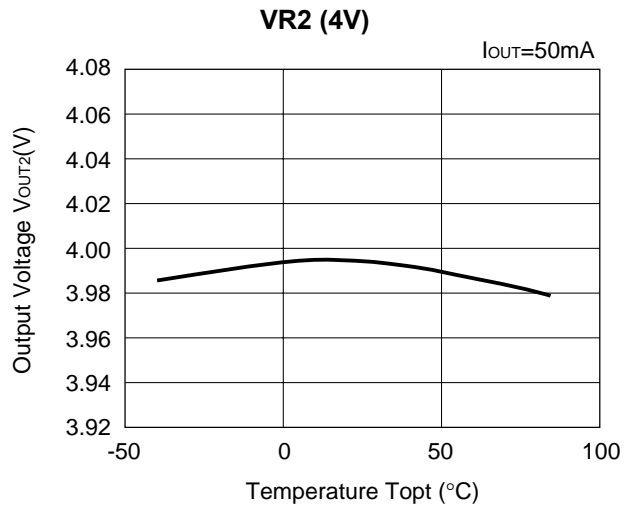
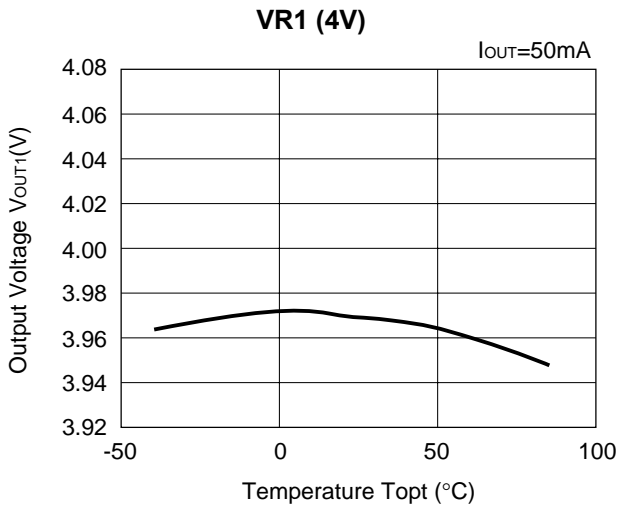

5) Input Voltage vs. Supply Current

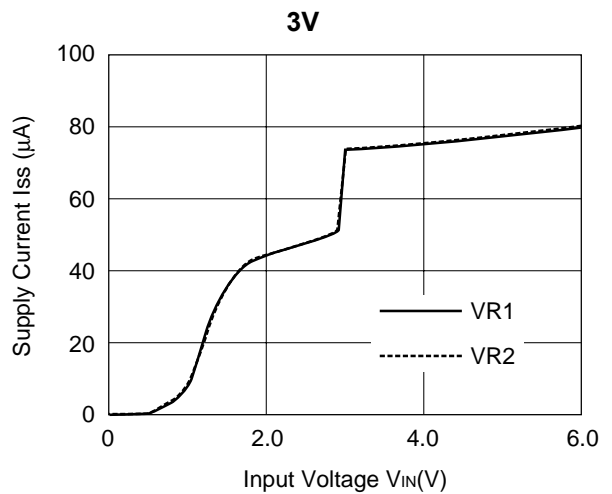
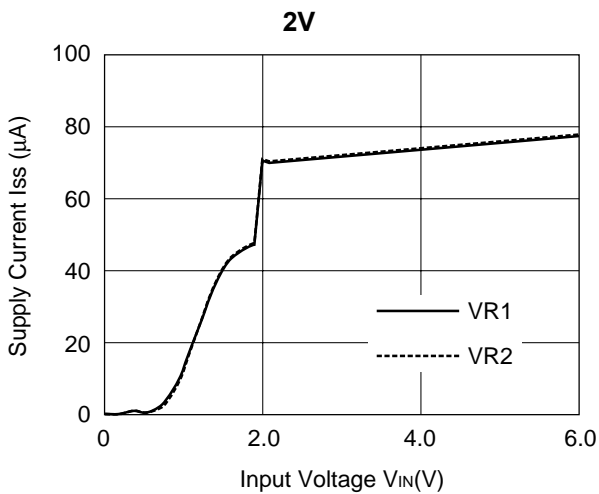

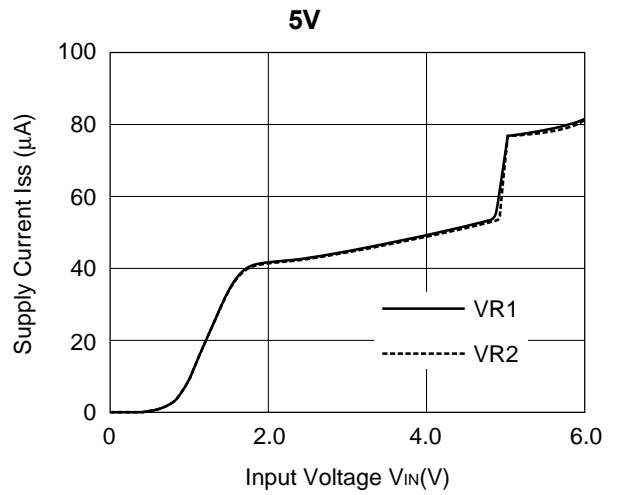
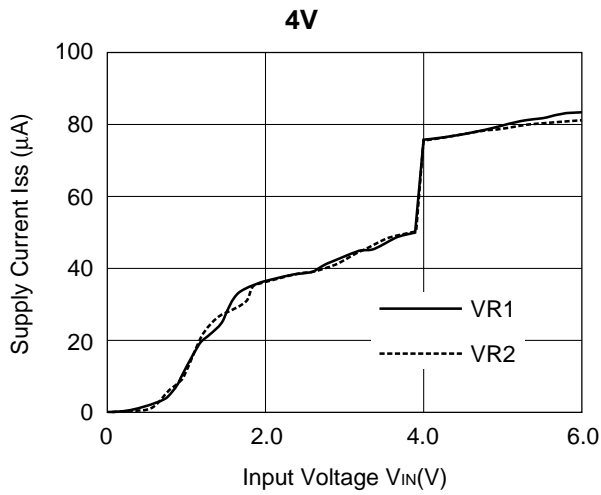

6) Supply Current vs. Temperature

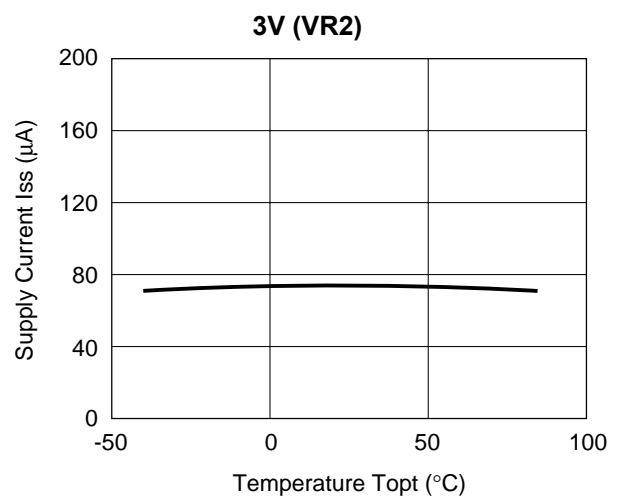
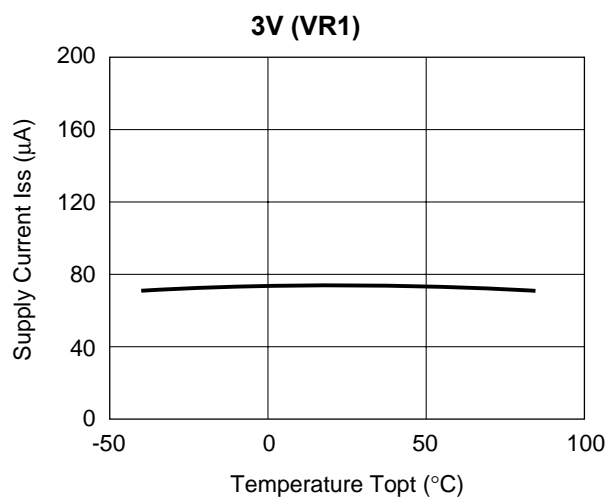
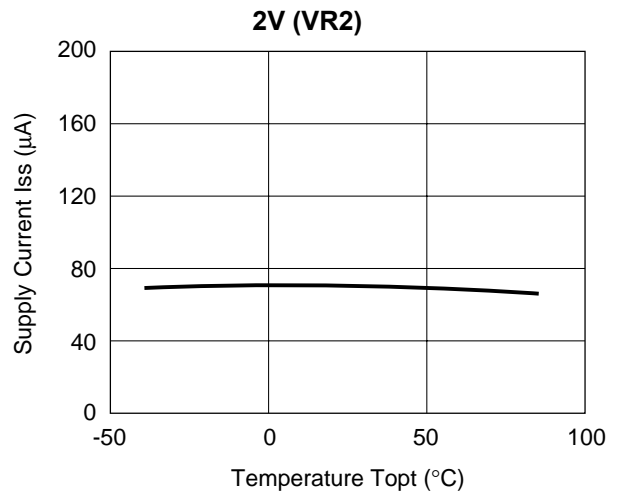
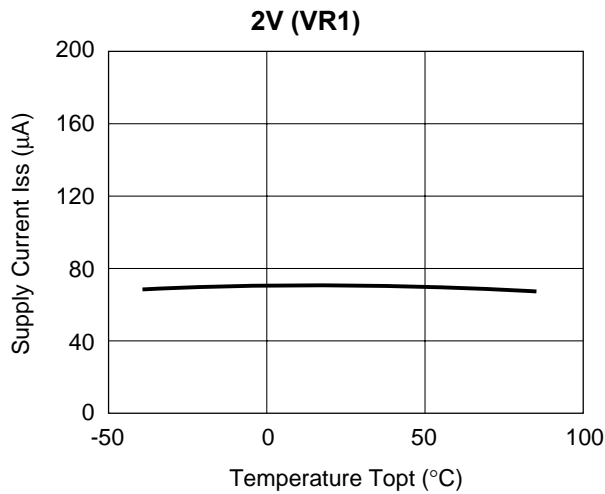

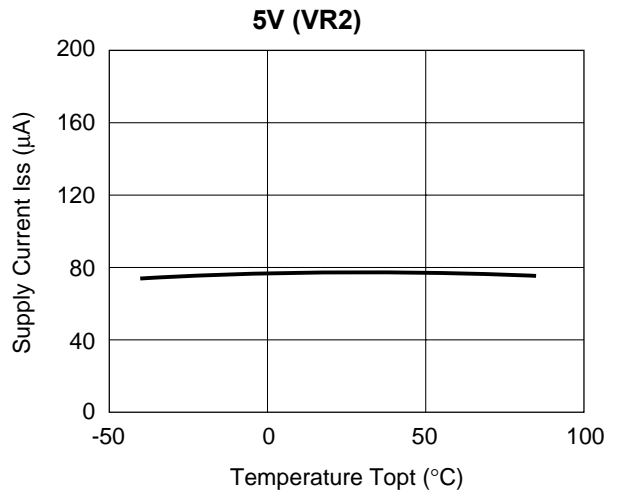
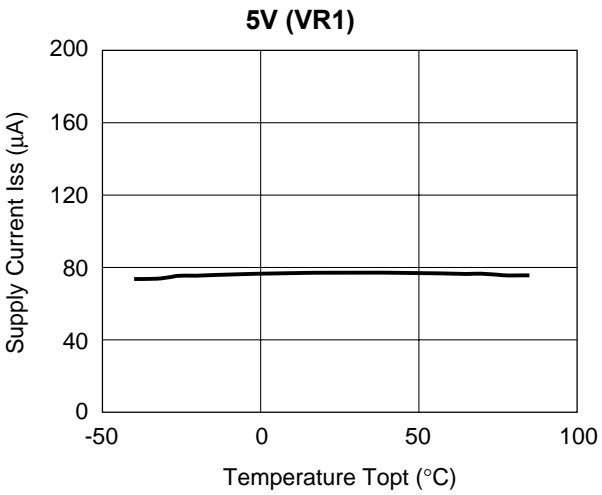
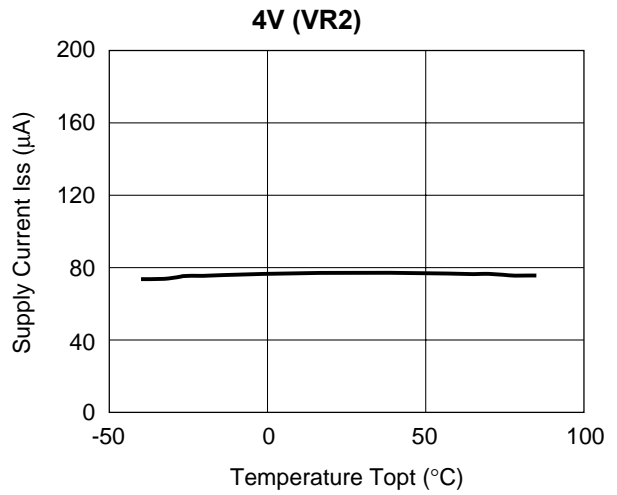
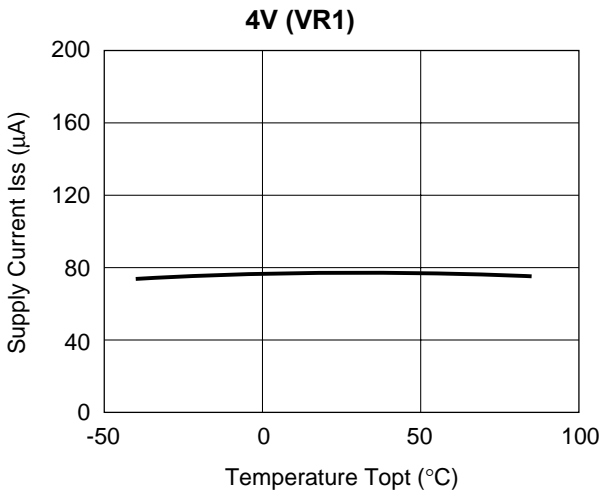

7) Dropout Voltage vs. Set Output Voltage

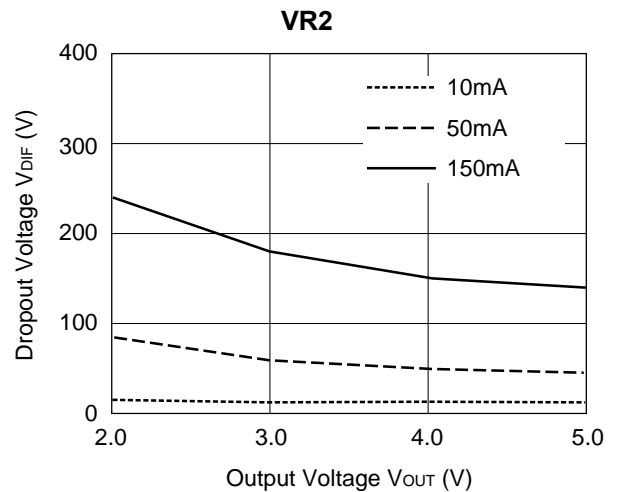
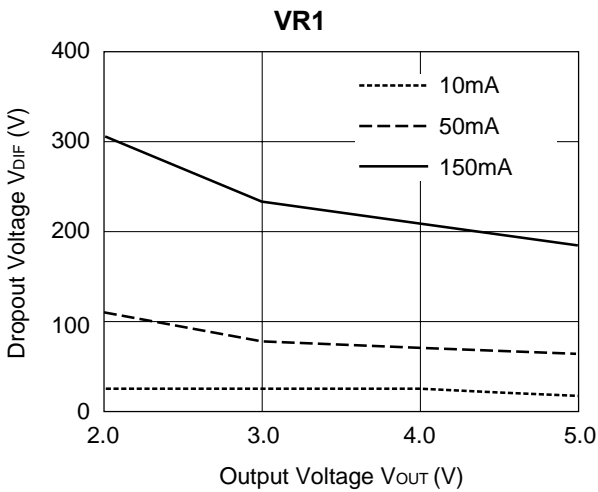

8) Ripple Rejection vs. Frequency

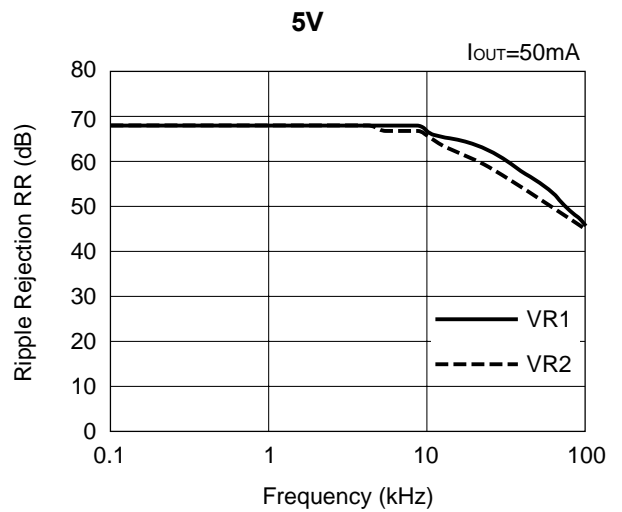
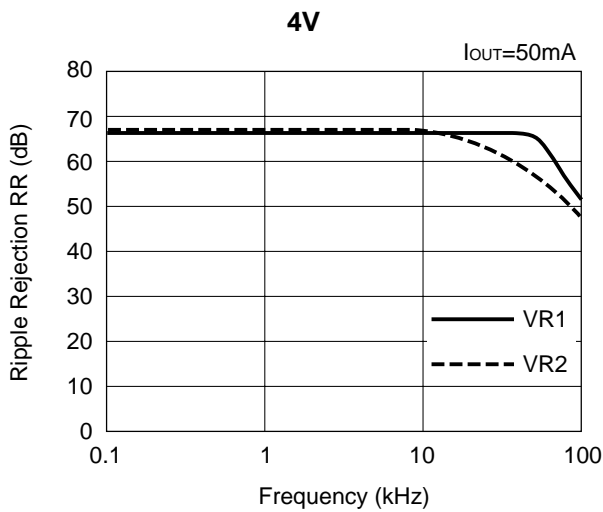
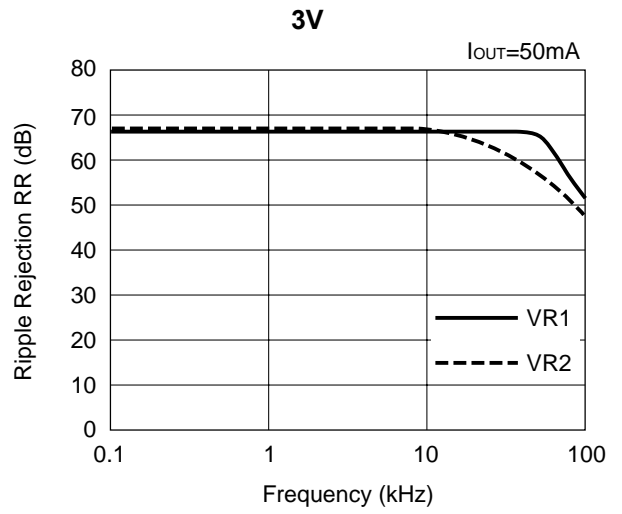
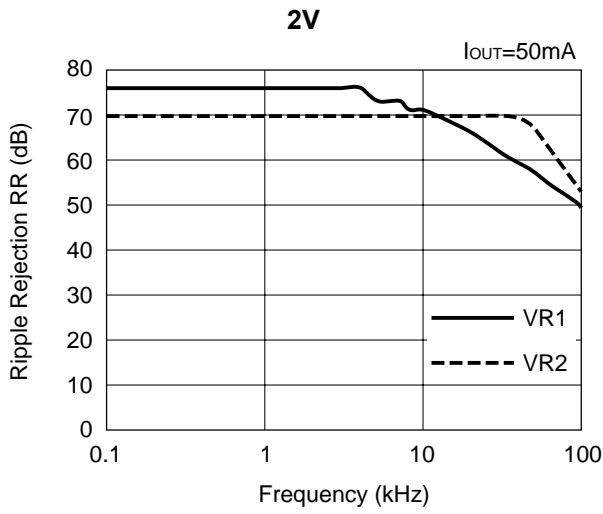

9) Dropout Voltage vs. Output Current

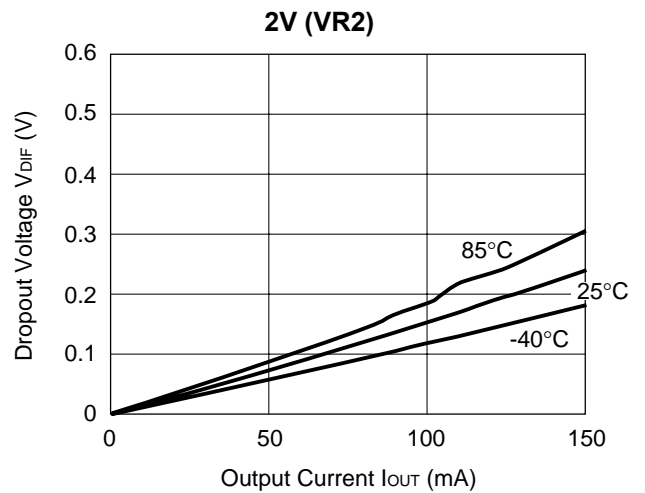
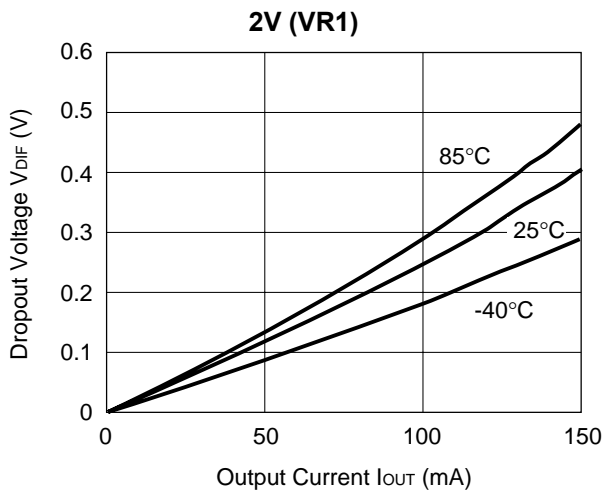

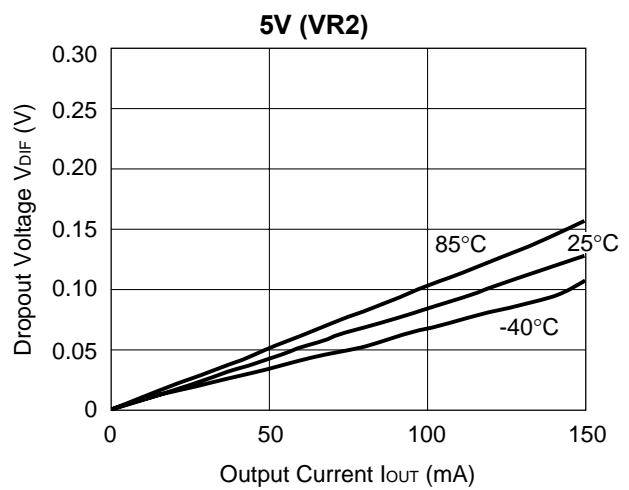
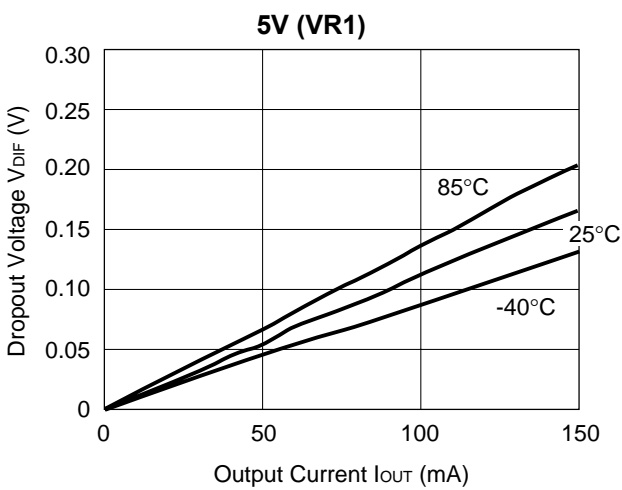
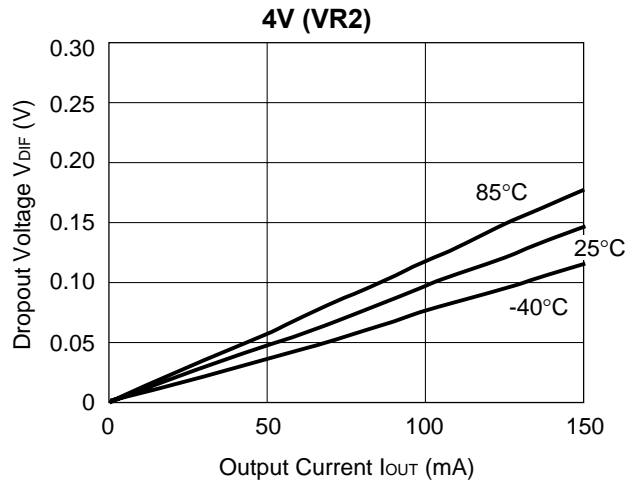
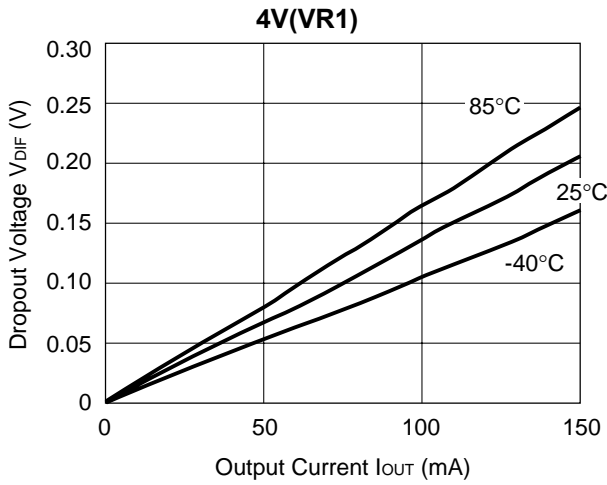
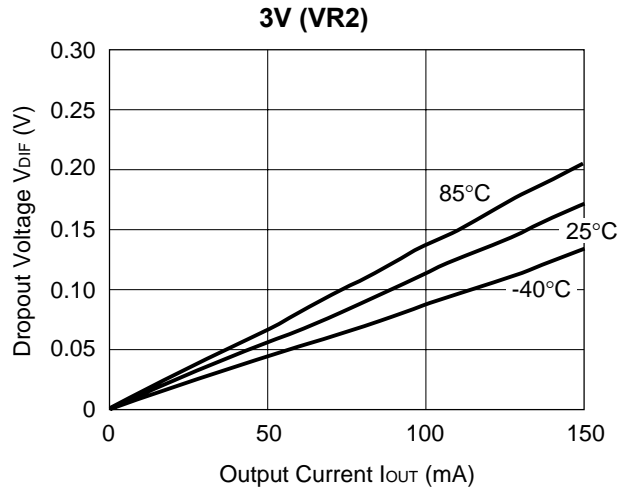
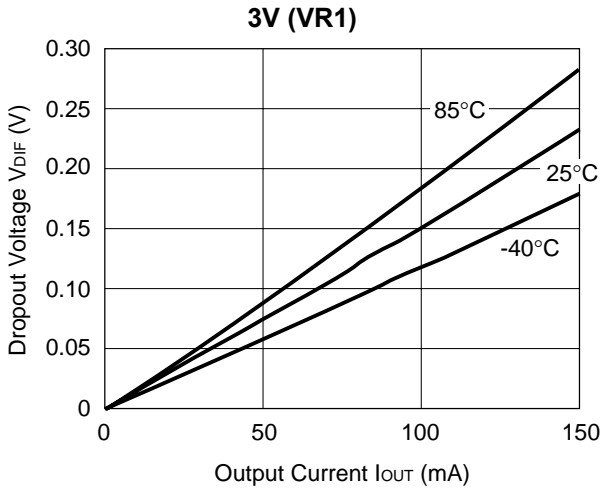

10) Line Transient Response

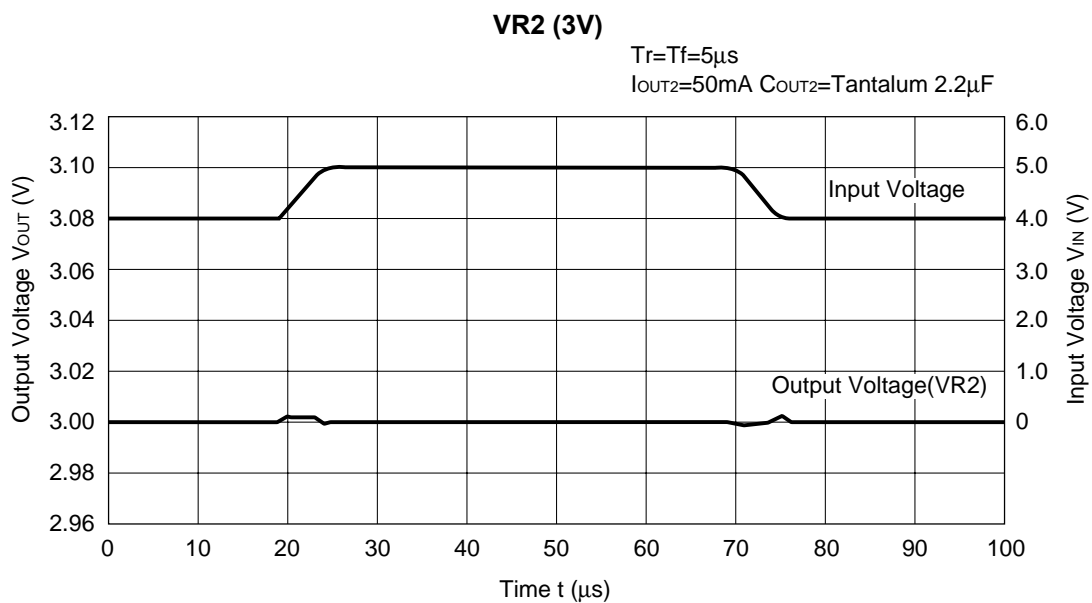
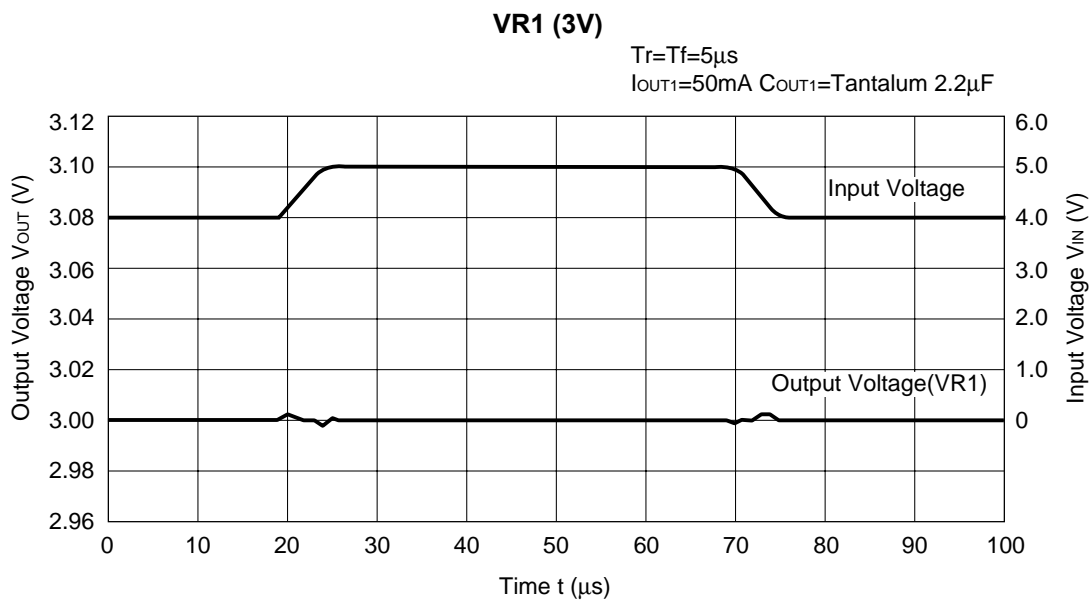

11) Load Transient Response

VR1

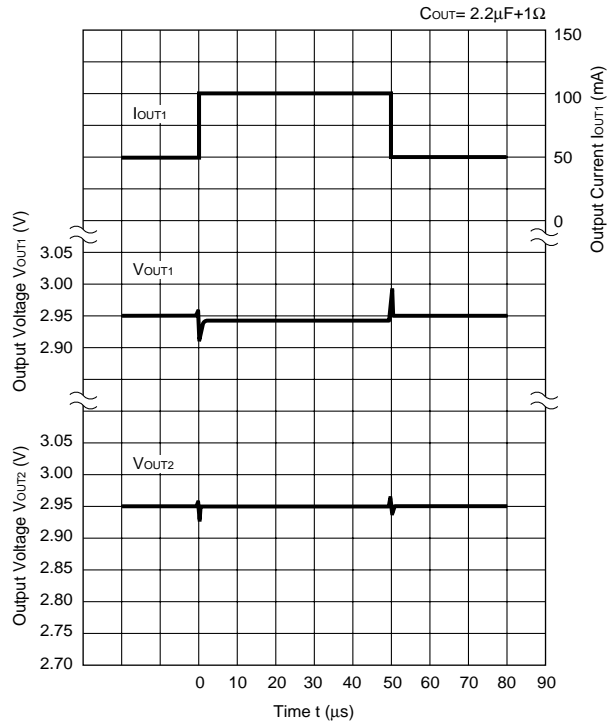

VR2

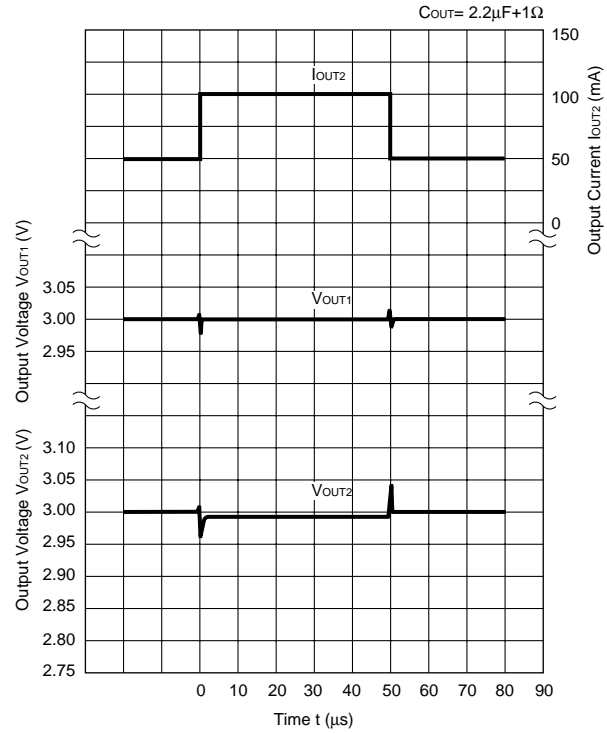

ESR vs. Output Current

To use this IC with ceramic capacitors, ESR should be set in the range of the following graphs.
 Test circuit for Noise level measurement is shown below;

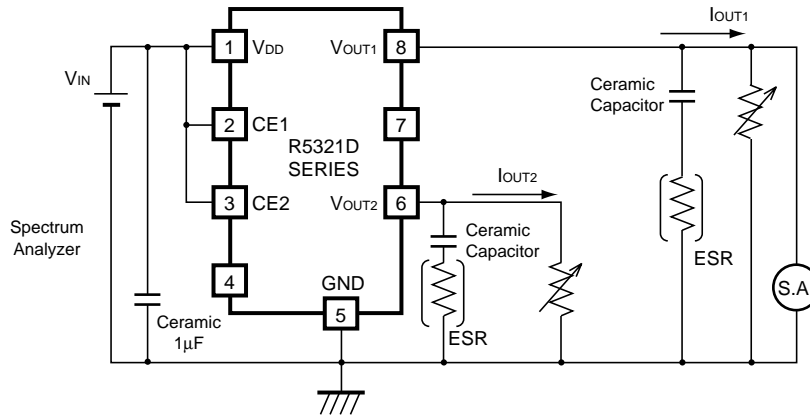

Noise level is measured with a spectrum analyzer and hatched area shows stable areas of which noise level is approximately equal or less than $40\mu\text{V}$ (Avg.). The relation between Load Current (I_{OUT}) and Equivalent Series Resistor (ESR) value of external output capacitor with the stable area is shown below;

<Measuring Conditions>

Frequency Band: 10Hz to 1MHz

Temperature: 25°C

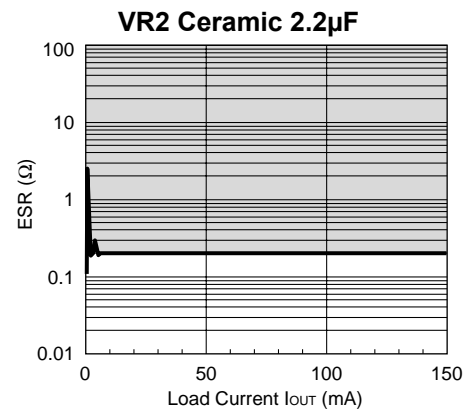
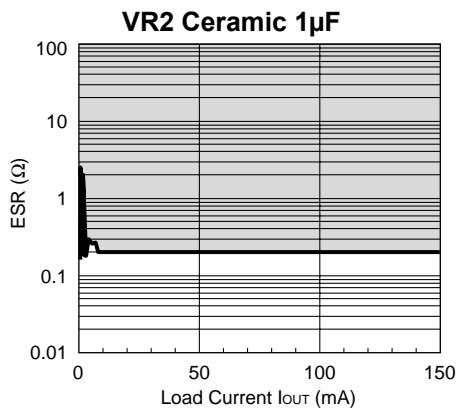
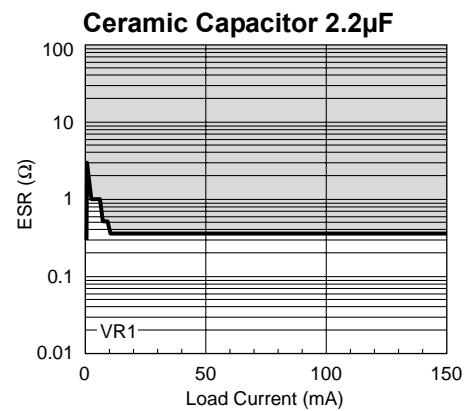
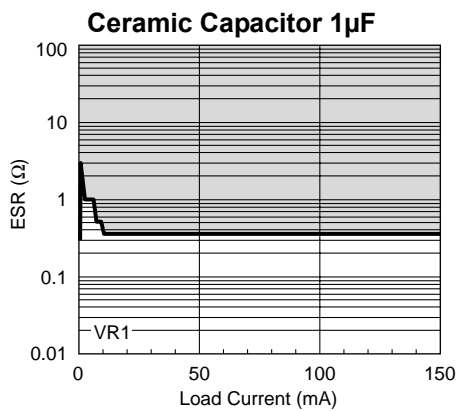

• SON-8

Unit: mm

PACKAGE DIMENSIONS

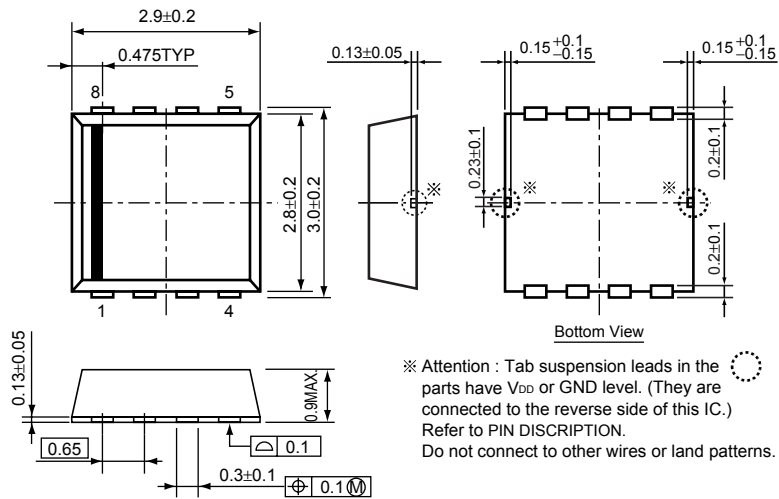

TAPING SPECIFICATION

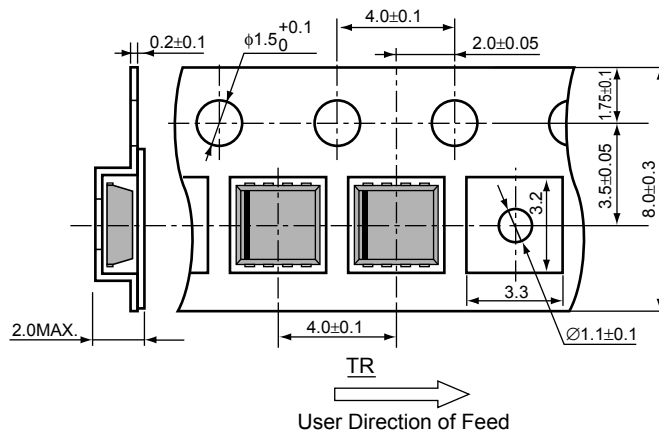

TAPING REEL DIMENSIONS

(1reel=3000pcs)

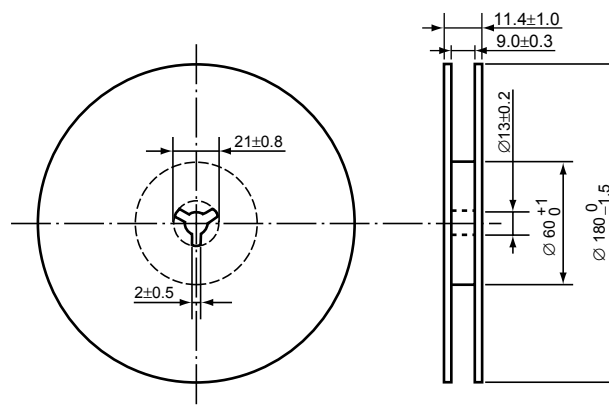

POWER DISSIPATION (SON-8)

This specification is at mounted on board. Power Dissipation (P_D) depends on conditions of mounting on board. This specification is based on the measurement at the condition below:

Measurement Conditions

	Standard Land Pattern
Environment	Mounting on Board (Wind velocity=0m/s)
Board Material	Glass cloth epoxy plactic (Double sided)
Board Dimensions	40mm × 40mm × 1.6mm
Copper Ratio	Top side : Approx. 50% , Back side : Approx. 50%
Through-hole	φ0.5mm × 44pcs

Measurement Result

($T_{opt}=25^{\circ}C, T_{jmax}=125^{\circ}C$)

	Standard Land Pattern	Free Air
Power Dissipation	480mW	300mW
Thermal Resistance	$\theta_{ja}=(125-25^{\circ}C)/0.48W=208^{\circ}C/W$	333 $^{\circ}C/W$

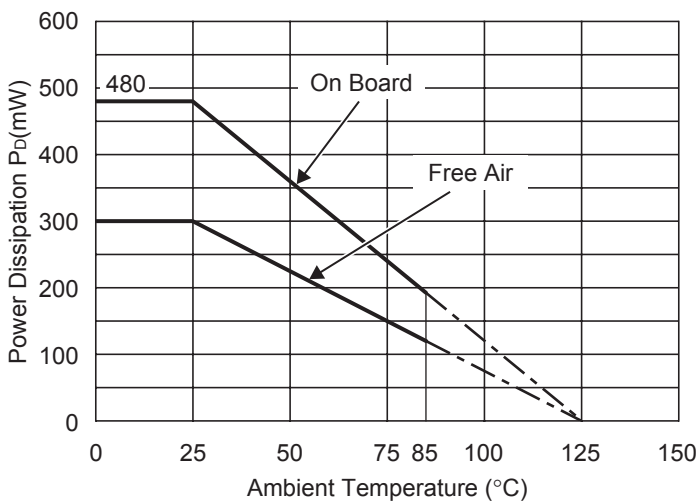

Power Dissipation

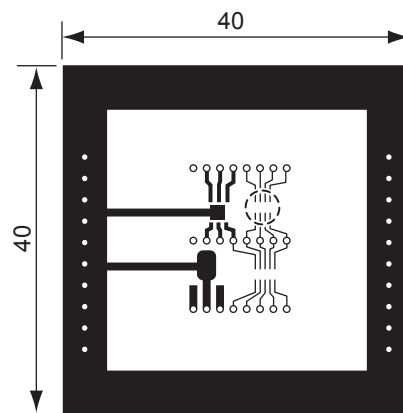

Measurement Board Pattern

○ IC Mount Area (Unit : mm)

RECOMMENDED LAND PATTERN

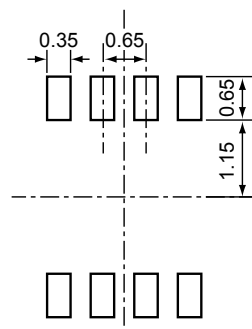

(Unit: mm)

R5321D SERIES MARK SPECIFICATION

- SON-8

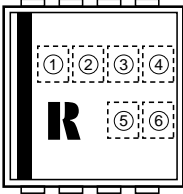

① to ④ : Product Code (refer to Part Number vs. Product Code)

⑤, ⑥ : Lot Number

- Part Number vs. Product Code

Part Number	Product Code			
	①	②	③	④
R5321D001A-TR	C	0	1	A
R5321D002A-TR	C	0	2	A
R5321D003A-TR	C	0	3	A
R5321D004A-TR	C	0	4	A
R5321D005A-TR	C	0	5	A
R5321D006A-TR	C	0	6	A
R5321D007A-TR	C	0	7	A
R5321D008A-TR	C	0	8	A
R5321D009A-TR	C	0	9	A
R5321D010A-TR	C	1	0	A
R5321D011A-TR	C	1	1	A