

PRELIMINARY

Notice: This is not a final specification.
Some parametric limits are subject to change.

MITSUBISHI DIODE MODULES
RM30TPM-M,-H
MEDIUM POWER GENERAL USE
INSULATED TYPE

RM30TPM-M,-H



- **I_o** DC output current **60A**
- **V_{RRM}** Repetitive peak reverse voltage
..... **400/800V**
- **3 phase bridge**
- **Insulated Type**

APPLICATION

AC motor controllers, DC motor controllers, Battery DC power supplies,
DC power supplies for control panels, and other general DC power equipment

OUTLINE DRAWING & CIRCUIT DIAGRAM

Dimensions in mm

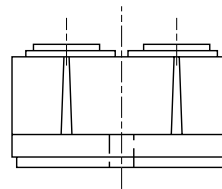
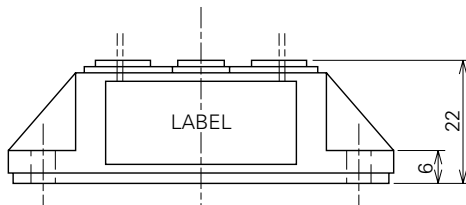
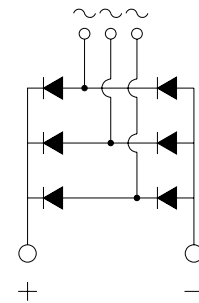
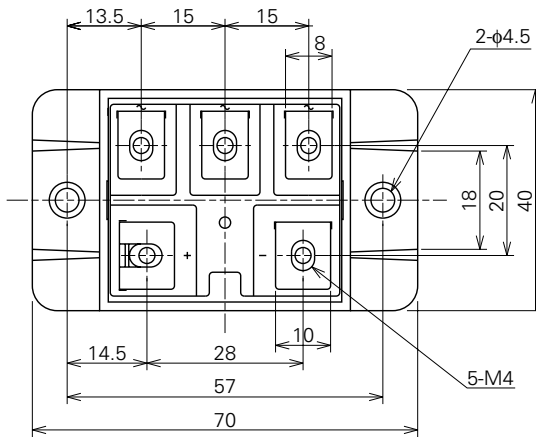

RM30TPM-M,-H

MEDIUM POWER GENERAL USE

INSULATED TYPE

ABSOLUTE MAXIMUM RATINGS

Symbol	Parameter	Voltage class		Unit
		M	H	
VRRM	Repetitive peak reverse voltage	400	800	V
VRSM	Non-repetitive peak reverse voltage	480	960	V
Ea	Recommended AC input voltage	110	220	V

Symbol	Parameter	Conditions	Ratings	Unit
Io	DC output current	Three-phase full wave rectifying circuit, Tc=105°C	60	A
IFSM	Surge (non-repetitive) forward current	One half cycle at 60Hz, peak value	600	A
I ² _t	I ² _t for fusing	Value for one cycle of surge current	1.5 × 10 ³	A ² s
f	Maximum operating frequency		1000	Hz
T _j	Junction temperature		-40~+150	°C
T _{stg}	Storage temperature		-40~+125	°C
V _{iso}	Isolation voltage	Charged part to case	2500	V
—	Mounting torque	Main terminal screw M4	0.98~1.47	N·m
			10~15	kg·cm
		Mounting screw M4	0.98~1.47	N·m
			10~15	kg·cm
—	Weight	Typical value	100	g

ELECTRICAL CHARACTERISTICS

Symbol	Parameter	Test conditions	Limits			Unit
			Min.	Typ.	Max.	
I _{RRM}	Repetitive reverse current	T _j =150°C, VRRM applied	—	—	10	mA
V _{FM}	Forward voltage	T _j =25°C, IFM=60A, instantaneous meas.	—	—	1.2	V
R _{th(j-c)}	Thermal resistance	Junction to case	—	—	0.31	°C/W
R _{th(c-f)}	Contact thermal resistance	Case to fin, conductive grease applied	—	—	0.09	°C/W
—	Insulation resistance	Measured with a 500V megohmmeter between main terminal and case	10	—	—	MΩ

RM30TPM-M,-H

MEDIUM POWER GENERAL USE
INSULATED TYPE

PERFORMANCE CURVES

MAXIMUM FORWARD CHARACTERISTIC

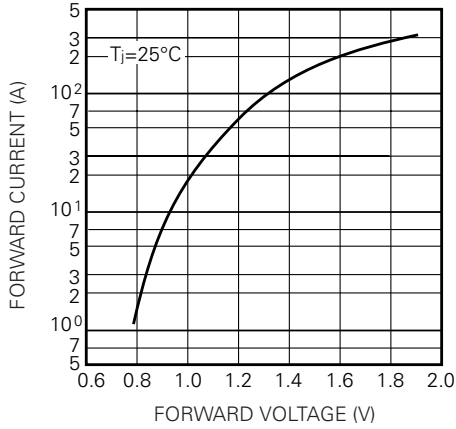

ALLOWABLE SURGE (NON-REPETITIVE) FORWARD CURRENT

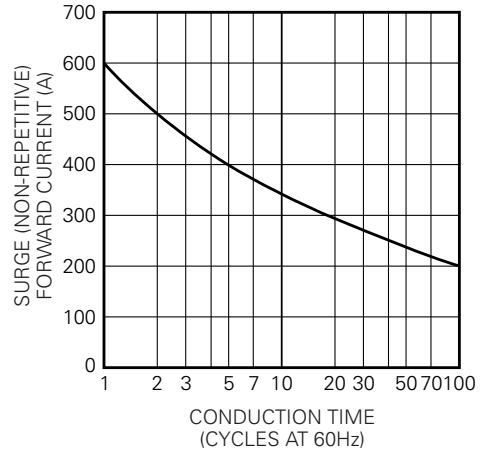

MAXIMUM TRANSIENT THERMAL IMPEDANCE (JUNCTION TO CASE)

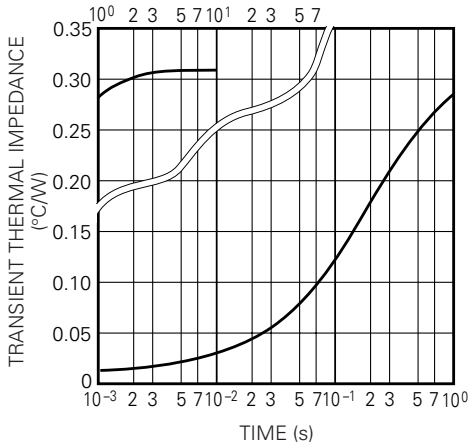

MAXIMUM POWER DISSIPATION

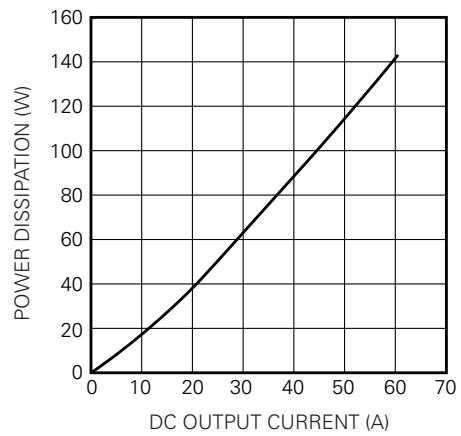

ALLOWABLE CASE TEMPERATURE VS. DC OUTPUT CURRENT

