

FEATURES

- Glass passivated junction
- For Surface Mount Applications, Easy to pick and place
- Plastic package has Underwriters Laboratory Flammability Classification 94V-0
- High temperature soldering guaranteed: 260°C/10 seconds at terminals,
- Component in accordance to RoHS 2011/65/EU

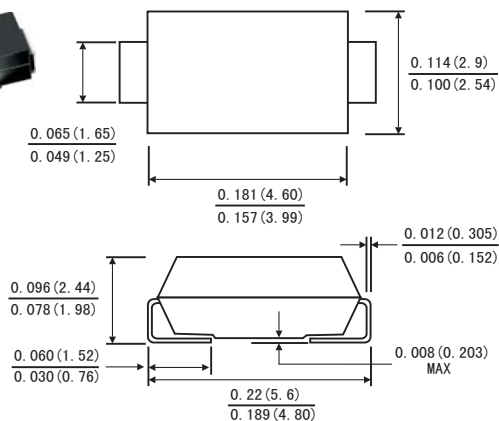

SMA(DO-214AC)



MECHANICAL DATA

- Case: JEDEC DO-214AC molded plastic over glass passivated chip
- Terminals: Solder plated
- Polarity: Color band denotes cathode end
- Weight: 0.002 ounce, 0.064 g

MAXIMUM RATINGS AND ELECTRICAL CHARACTERISTICS

(Rating at 25°C ambient temperature unless otherwise specified. Single phase, half wave, 60Hz, resistive or inductive load. For capacitive load, derate current by 20%.)

	Symbols	RS2A	RS2B	RS2D	RS2G	RS2J	RS2K	RS2M	Units
Maximum Recurrent Peak Reverse Voltage	V_{RRM}	50	100	200	400	600	800	1000	Volts
Maximum RMS Voltage	V_{RMS}	35	70	140	280	420	560	700	Volts
Maximum DC Blocking Voltage	V_{DC}	50	100	200	400	600	800	1000	Volts
Maximum Average Forward Rectified Current	$I_{(AV)}$	2.0							Amps
Peak Forward Surge Current 8.3ms single half sine-wave superimposed on rated load (JEDEC method)	I_{FSM}	50.0							Amps
Maximum Instantaneous Forward Voltage at 2.0 A	V_F	1.3							Volts
Maximum DC Reverse Current at rated DC blocking voltage	$T_A=25^\circ\text{C}$	5.0							μA
	$T_A=125^\circ\text{C}$								
Maximum reverse recovery time(Note1)	t_{rr}	150				250	500		ns
Typical junction capacitance(Note2)	C_J	30.0							pF
Operating junction and storage temperature range	T_J T_{STG}	-55 to +150							$^\circ\text{C}$

Note: 1. Test conditions: $I_F=0.5\text{A}$, $I_R=1.0\text{A}$, $I_{RR}=0.25\text{A}$.

2. Measured at 1MHz and applied reverse voltage of 4.0 Volts D.C.

RATINGS AND CHARACTERISTIC CURVES RS2A THRU RS2M

FIG.1-TYPICAL FORWARD CURRENT DERATING CURVE

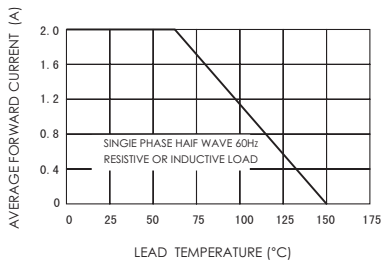

FIG.2-MAXIMUM NON-REPETITIVE FORWARD SURGE CURRENT

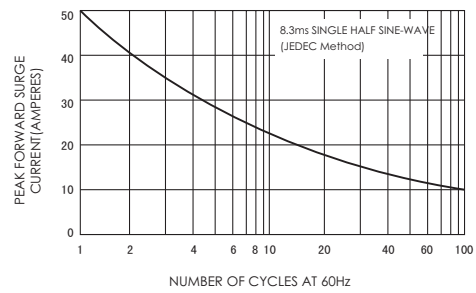

FIG.3-TYPICAL INSTANTANEOUS FORWARD CHARACTERISTICS

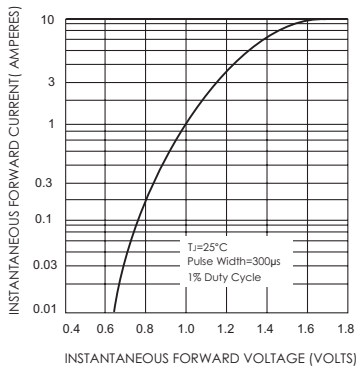

FIG.4-TYPICAL REVERSE CHARACTERISTICS

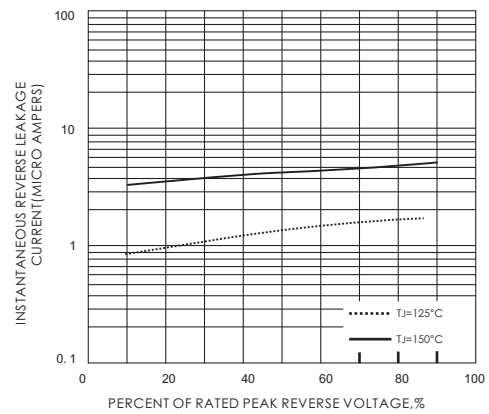
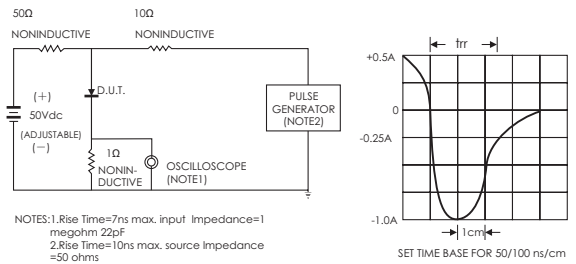
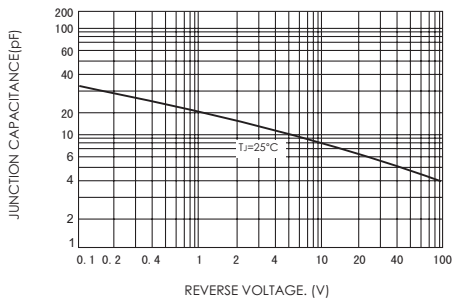

FIG.6-TEST CIRCUIT DIAGRAM AND REVERSE RECOVERY TIME CHARACTERISTIC

FIG.5-TYPICAL JUNCTION CAPACITANCE



NOTES: 1. Rise Time=7ns max. input Impedance=1 megohm 22pF
2. Rise Time=10ns max. source impedance =50 ohms