



RS2ABF THRU RS2MBF

Reverse Voltage - 50 to 1000 Volts Forward Current - 2.0 Ampere

SURFACE MOUNT FAST RECOVERY RECTIFIER

Features

- ◆ The plastic package carries Underwriters Laboratory Flammability Classification 94V-0
- ◆ For surface mounted applications
- ◆ Fast switching for high efficiency
- ◆ Low reverse leakage
- ◆ Built-in strain relief, ideal for automated placement
- ◆ High forward surge current capability
- ◆ High temperature soldering guaranteed:
260°C/10 seconds at terminals
Glass passivated chip junction

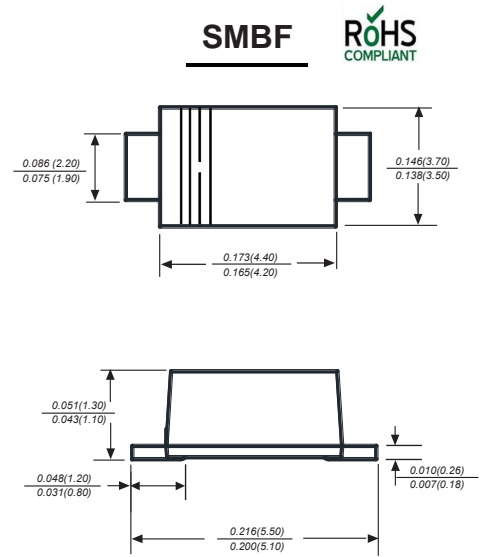

Dimensions in inches and (millimeters)

Mechanical Data

Case : JEDEC DO-214AC/SMBF Molded plastic body
Terminals : Solder plated, solderable per MIL-STD-750, Method 2026
Polarity : Polarity symbol marking on body
Mounting Position : Any
Weight : 0.00095ounce, 0.027 grams

Maximum Ratings And Electrical Characteristics

Ratings at 25°C ambient temperature unless otherwise specified.

Single phase half-wave 60Hz, resistive or inductive load, for capacitive load current derate by 20%.

Parameter	SYMBOLS	RS2ABF	RS2BBF	RS2DBF	RS2GBF	RS2JBF	RS2KBF	RS2MBF	UNITS
		MDD RS2ABF	MDD RS2BBF	MDD RS2DBF	MDD RS2GBF	MDD RS2JBF	MDD RS2KBF	MDD RS2MBF	
Maximum repetitive peak reverse voltage	V_{RMM}	50	100	200	400	600	800	1000	V
Maximum RMS voltage	V_{RMS}	35	70	140	280	420	560	700	V
Maximum DC blocking voltage	V_{DC}	50	100	200	400	600	800	1000	V
Maximum average forward rectified current at $T_L=90^\circ\text{C}$	$I_{(AV)}$	2.0							A
Peak forward surge current 8.3ms single half sine-wave superimposed on rated load (JEDEC Method)	I_{FSM}	50							A
Maximum instantaneous forward voltage at 2.0A	V_F	1.30							V
Maximum DC reverse current $T_A=25^\circ\text{C}$ at rated DC blocking voltage $T_A=125^\circ\text{C}$	I_R	5.0 100.0							μA
Maximum reverse recovery time (NOTE 1)	t_{rr}	150			250		500		ns
Typical junction capacitance (NOTE 2)	C_J	28.0							pF
Typical thermal resistance (NOTE 3)	$R_{\theta JA}$	60.0							$^\circ\text{C}/\text{W}$
Operating junction and storage temperature range	T_J, T_{STG}	-55 to +150							$^\circ\text{C}$

Note: 1. Reverse recovery condition $I_F=0.5\text{A}, I_R=1.0\text{A}, I_{rr}=0.25\text{A}$
 2. P.C.B. mounted with 2.0" X 2.0" (5 X 5 cm) copper pad areas.
 3. The typical data above is for reference only.



Ratings And Characteristic Curves

Fig.1 Forward Current Derating Curve

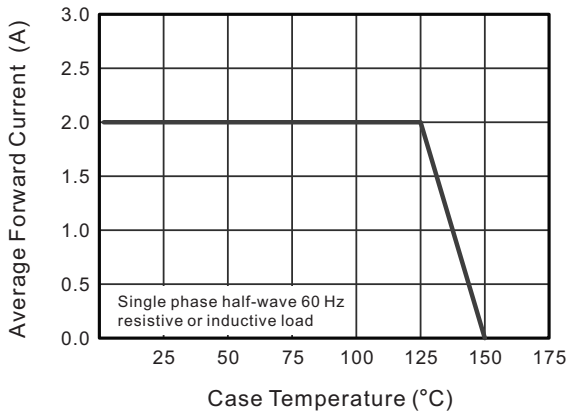

Fig.2 Typical Reverse Characteristics

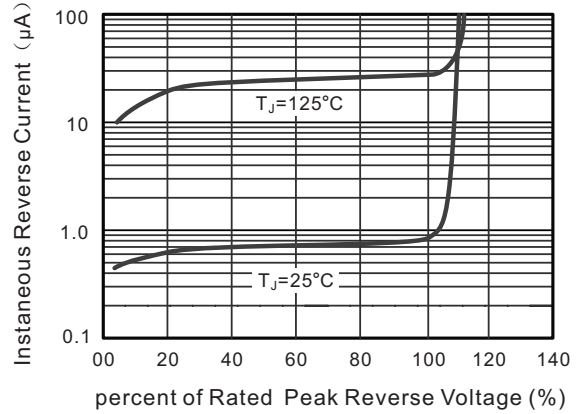

Fig.3 Typical Instantaneous Forward Characteristics

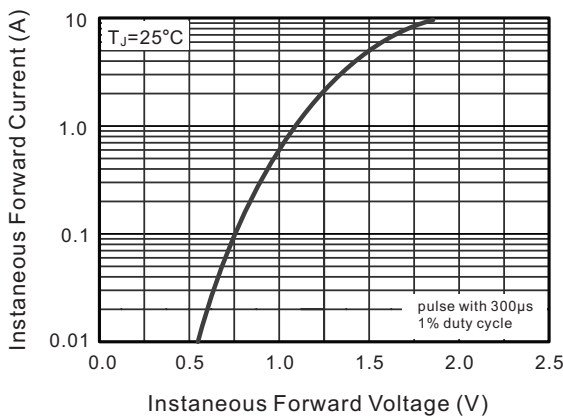

Fig.4 Typical Junction Capacitance

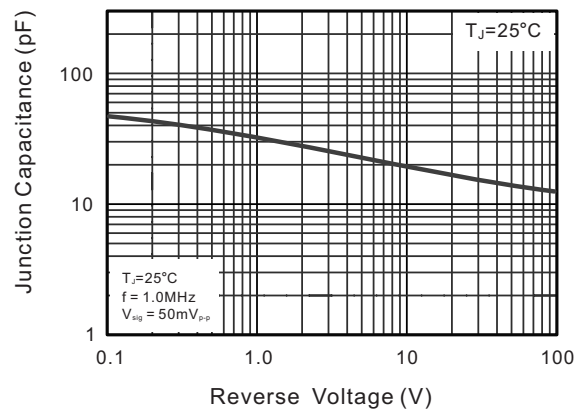
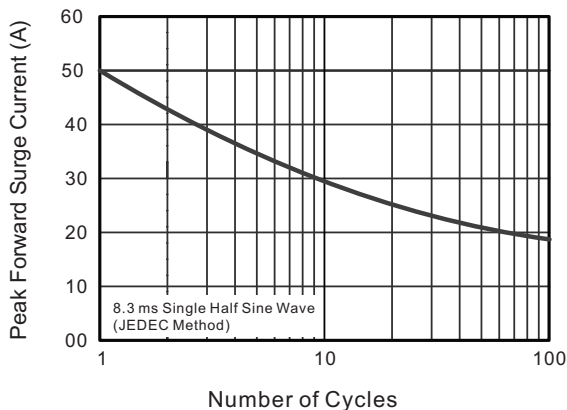

Fig.5 Maximum Non-Repetitive Peak Forward Surge Current



The curve above is for reference only.



RS2ABF THRU RS2MBF

Reverse Voltage - 50 to 1000 Volts Forward Current - 2.0 Ampere

Packing information



unit:mm

Item	Symbol	Tolerance	SMBF
Carrier width	A	0.1	3.81
Carrier length	B	0.1	5.61
Carrier depth	C	0.1	1.60
Sprocket hole	d	0.05	1.50
13" Reel outside diameter	D	2.0	330.00
13" Reel inner diameter	D1	min	50.00
Feed hole diameter	D2	0.5	13.00
Sprocket hole position	E	0.1	1.75
Punch hole position	F	0.1	5.50
Punch hole pitch	P	0.1	4.00
Sprocket hole pitch	P0	0.1	4.00
Embossment center	P1	0.1	2.00
Overall tape thickness	T	0.1	0.30
Tape width	W	0.3	12.00
Reel width	W1	1.0	12.30

Note: Devices are packed in accordance with EIA standard RS-481-A and specifications listed above.

Reel packing

PACKAGE	REEL SIZE	REEL (pcs)	COMPONENT SPACING (mm)	BOX (pcs)	INNER BOX (mm)	REEL DIA. (mm)	CARTON SIZE (mm)	CARTON (pcs)	APPROX. GROSS WEIGHT (kg)
SMBF	13"	5,000	4.0	10,000	190*190*41	330	365*365*360	80,000	14.0

Suggested Pad Layout

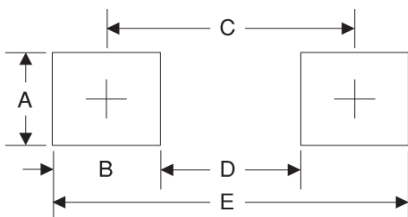

Symbol	Unit (mm)	Unit (inch)
A	2.54	0.100
B	1.8	0.071
C	4.8	0.189
D	3.0	0.118
E	6.6	0.260

Important Notice and Disclaimer

Microdiode Electronics (Jiangsu) reserves the right to make changes to this document and its products and specifications at any time without notice. Customers should obtain and confirm the latest product information and specifications before final design, purchase or use.

Microdiode Electronics (Jiangsu) makes no warranty, representation or guarantee regarding the suitability of its products for any particular purpose, nor does Microdiode Electronics (Jiangsu) assume any liability for application assistance or customer product design. Microdiode Electronics (Jiangsu) does not warrant or accept any liability with products which are purchased or used for any unintended or unauthorized application.

No license is granted by implication or otherwise under any intellectual property rights of Microdiode Electronics (Jiangsu).

Microdiode Electronics (Jiangsu) products are not authorized for use as critical components in life support devices or systems without express written approval of Microdiode Electronics (Jiangsu).