

Features

3.2 (L) x 2.8 (W) x 3.4 (H) mm Size
 2.8 mm Diameter Lens-top Type
 InGaAlP Technology (High-Bright type)
 Low Drive Current, High Intensity Light Emission
 High Operating Temperature
 Standard Embossed Taping 8 mm Pitch : T10 (500 pcs/reel)

Applications

Automotive Use
 Message Signboard
 Backlight

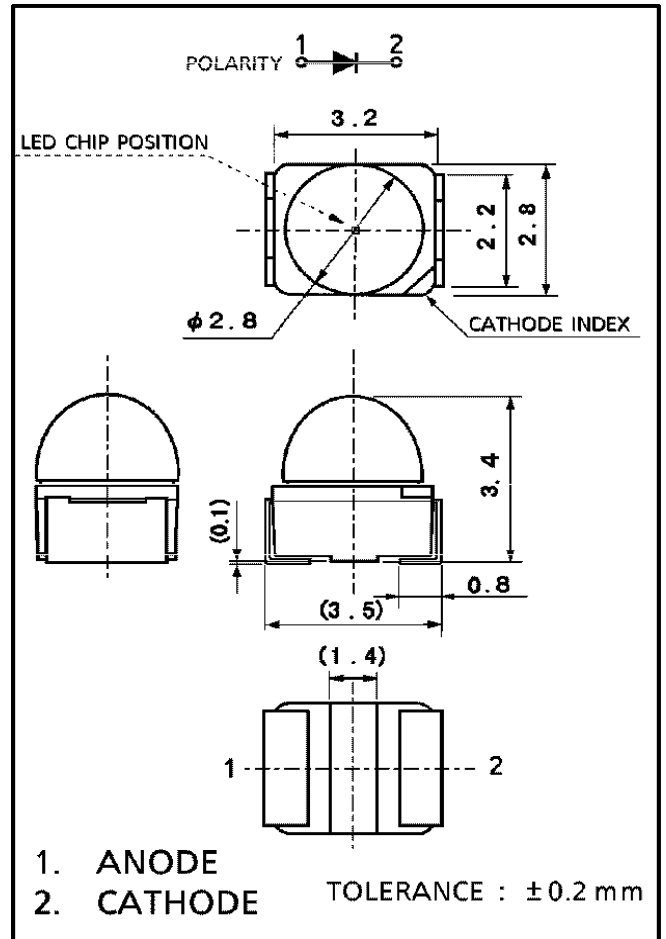

Series Line-Up

Part Number	Color	Material
S4F43Q1	Ultra Bright Yellow Green	InGaAlP
S4F43Z1	Ultra Pure Green	InGaAlP

Maximum Ratings (Ta=25°C)

Part Number	Forward Current I _F	Reverse Voltage V _R	Power Dissipation P _D	Operating Temperature T _{opr}	Storage Temperature T _{stg}
S4F43Q1	50	4	140.00	-40 ~ 100	-40 ~ 100
S4F43Z1	50	4	140.00	-40 ~ 100	-40 ~ 100
Unit	mA	V	mW	°C	°C

Company Headquarters
 120 Broadway
 Menands, New York 12204
 Toll Free: 800.984.5337
 Fax: 518.432.7454



Web: www.marktechopto.com | Email: info@marktechopto.com

West Coast Sales Office
 950 South Coast Drive, Suite 265
 Costa Mesa, California 92626
 Toll Free: 800.984.5337
 Fax: 714.850.9314

Electrical and Optical Characteristics (Ta=25°C)

Part Number	PWL nm λ_P	Material	View Angle $2\theta_{1/2}$	Luminous Intensity I_v				Forward Voltage V_F				Rev Current I_R	
				min.	typ.	max.	IF@	min.	typ.	max.	IF@	max.	VR@
S4F43Q1	574	InGaAlP	56°	85.00	250.00	–	20mA	–	2.27	2.80	20mA	50	4V
S4F43Z1	562	InGaAlP	56°	27.20	60.00	–	20mA	–	2.27	2.80	20mA	50	4V
–	nm	–	deg	mcd				–	V		–	μ A	–

NOTICE:

- TOSHIBA is continually working to improve the quality and reliability of its products. Nevertheless, semiconductor devices in general can malfunction or fail due to their inherent electrical sensitivity and vulnerability to physical stress. It is the responsibility of the buyer, when utilizing TOSHIBA products, to comply with the standards of safety in making a safe design for the entire system, and to avoid situations in which a malfunction or failure of such TOSHIBA products could cause loss of human life, bodily injury or damage to property.
- In developing your designs, please ensure that TOSHIBA products are used within specified operating ranges as set forth in the most recent TOSHIBA products specifications. Also, please keep in mind the precautions and conditions set forth in the "Handling Guide for Semiconductor Devices," or "TOSHIBA Semiconductor Reliability Handbook" etc..
- The TOSHIBA products listed in this document are intended for usage in general electronics applications (computer, personal equipment, office equipment, measuring equipment, industrial robotics, domestic appliances, etc.). These TOSHIBA products are neither intended nor warranted for usage in equipment that requires extraordinarily high quality and/or reliability or a malfunction or failure of which may cause loss of human life or bodily injury ("Unintended Usage"). Unintended Usage include atomic energy control instruments, airplane or spaceship instruments, transportation instruments, traffic signal instruments, combustion control instruments, medical instruments, all types of safety devices, etc.. Unintended Usage of TOSHIBA products listed in this document shall be made at the customer's own risk.
- Gallium arsenide (GaAs) is a substance used in the products described in this document. GaAs dust and fumes are toxic. Do not break, cut or pulverize the product, or use chemicals to dissolve them. When disposing of the products, follow the appropriate regulations. Do not dispose of the products with other industrial waste or with domestic garbage.
- The information contained herein is presented only as a guide for the applications of our products. No responsibility is assumed by TOSHIBA CORPORATION for any infringements of intellectual property or other rights of the third parties which may result from its use. No license is granted by implication or otherwise under any intellectual property or other rights of TOSHIBA CORPORATION or others.
- The information contained herein is subject to change without notice.

Company Headquarters
 120 Broadway
 Menands, New York 12204
 Toll Free: 800.984.5337
 Fax: 518.432.7454



Web: www.marktechopto.com | Email: info@marktechopto.com

West Coast Sales Office
 950 South Coast Drive, Suite 265
 Costa Mesa, California 92626
 Toll Free: 800.984.5337
 Fax: 714.850.9314

S4F43Q1 Graphs

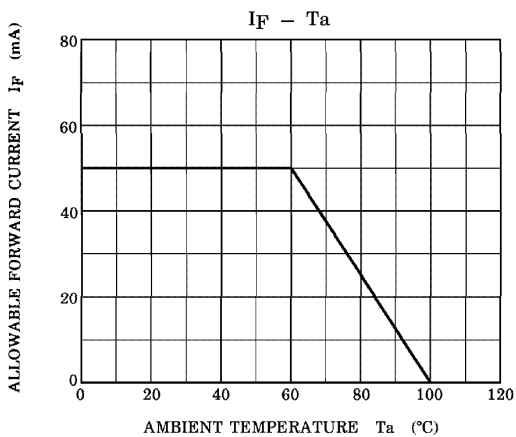
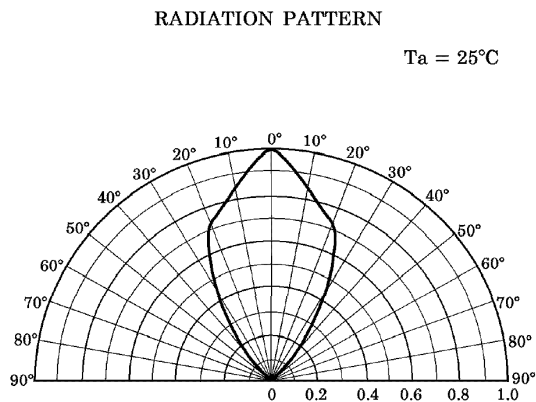
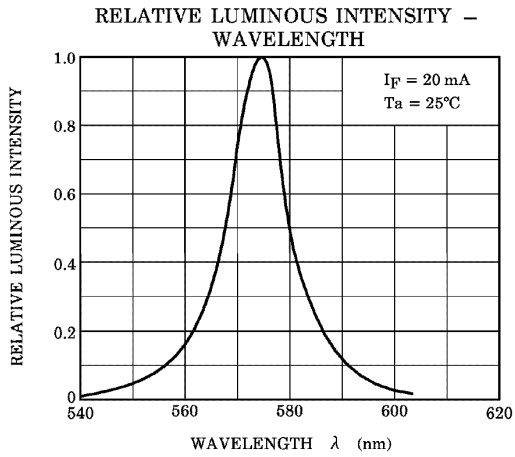
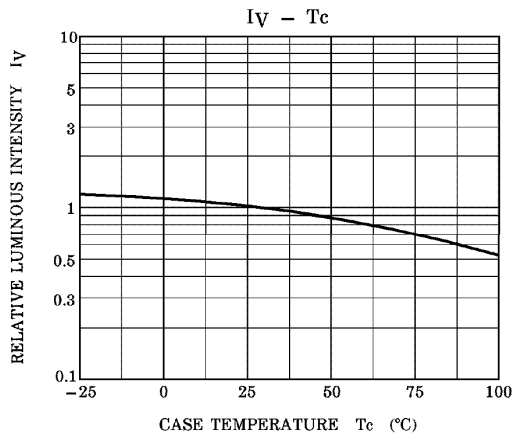
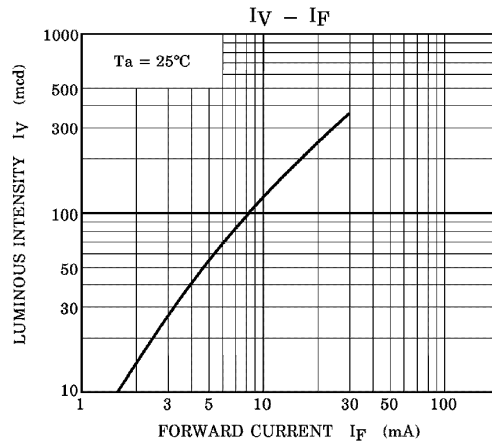
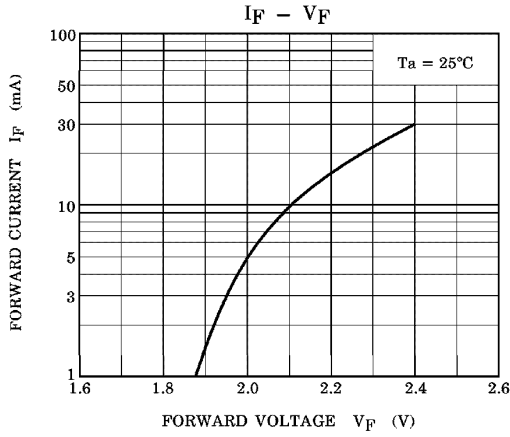

S4F43Z1 Graphs

